

Altanium Delta5

User Guide



HUSKY[®]

Keeping our customers in the lead

Issue: v 2.0 — March 2023

This product manual is intended to provide information for safe operation and/or maintenance. Husky reserves the right to make changes to products in an effort to continually improve the product features and/or performance. These changes may result in different and/or additional safety measures that are communicated to customers through bulletins as changes occur.

This document contains information which is the exclusive property of Husky Injection Molding Systems Limited. Except for any rights expressly granted by contract, no further publication or commercial use may be made of this document, in whole or in part, without the prior written permission of Husky Injection Molding Systems Limited.

Notwithstanding the foregoing, Husky Injection Molding Systems Limited grants permission to its customers to reproduce this document for limited internal use only.

Husky® product or service names or logos referenced in these materials are trademarks of Husky Injection Molding Systems Ltd. and may be used by certain of its affiliated companies under license.

All third-party trademarks are the property of the respective third-party and may be protected by applicable copyright, trademark or other intellectual property laws and treaties. Each such third-party expressly reserves all rights into such intellectual property.

© 2023 Husky Injection Molding Systems. All rights reserved.

General Information

Telephone Support Numbers

North America	Toll free	1-800-465-HUSKY (4875)
Europe	EC (most countries)	008000 800 4300
	Direct and Non-EC	+ (352) 52115-4300
Asia	Toll Free	800-820-1667 or +800-4875-9477
	Direct:	+86-21-3849-4520
Latin America	Brazil	+55-11-4589-7200
	Mexico	+52-5550891160 option 5

For on-site service, contact the nearest Husky Regional Service and Sales office.

For non-emergency questions and issues, e-mail Husky at techsupport@husky.ca.

Husky Regional Service and Sales Offices

For the nearest location, please visit www.husky.co.

Product Upgrades

Upgrades are available that can improve output, reduce cycle times, and add functionality to Husky equipment.

To see what upgrades are available, visit www.husky.co or call the nearest Husky Regional Service and Sales Office.

Ordering Spare Parts

All spare parts for Husky equipment can be ordered through the nearest Husky Parts Distribution Center or online at www.husky.co.

Ordering Additional Manuals

Additional copies of this manual and other documentation can be purchased through the nearest Husky Regional Service and Sales office.

Table of Contents

General Information	iii
Telephone Support Numbers	iii
Husky Regional Service and Sales Offices	iii
Product Upgrades	iii
Ordering Spare Parts	iii
Ordering Additional Manuals	iii
Chapter 1: Introduction	1
1.1 General Safety	1
1.1.1 Safety Signs	2
1.2 Purpose of the Equipment	3
1.3 Restrictions of Use	3
1.4 Input Wiring (Conventional)	3
1.5 Environmental Operating Specifications	4
1.6 Equipment Ratings	4
1.7 Technical Specifications	4
1.8 Controller Lifting Instructions	5
Chapter 2: Hot Runner Temperature Control	9
2.1 Types of Temperature Control	9
2.1.1 Open Loop Control	9
2.2 Configuring Zones	9
2.2.1 Configure a Zone for Zero Cross Control	10
2.2.2 Configure a Zone for Phase Angle Control	10
2.3 Determine the Heater Size	10
2.4 Thermocouple Types and Color Codes	11
Chapter 3: Connect the System to the Mold	13
3.1 Before Startup	13
3.2 Connect to the Power Source	13
3.3 Startup Procedure Checklist	14
Chapter 4: Altanium Operator Interface	15
4.1 General	15
4.1.1 Altanium Operator Interface	15
4.1.2 Home Screen	16
4.1.3 Altanium Buttons	17

4.1.3.1	Controller Function Buttons.....	17
4.1.3.2	System Status Field.....	18
4.1.3.3	Navigation Buttons.....	18
4.1.3.4	Alarm Buttons.....	19
4.1.3.5	System and User Management Buttons.....	20
4.1.4	Dialog Window Buttons.....	21
4.1.5	System Modes.....	21
4.1.6	Servo Control.....	23
4.1.7	Temperature Control Views.....	23
4.1.8	Temperature Control.....	24
4.1.9	Common Buttons.....	25
4.1.10	System Configuration Buttons.....	26
4.2	Screen Keyboards, Keypads, and Selection Menus.....	26
4.2.1	Keypad Use.....	28
4.2.1.1	Enter a Specified Setpoint Value.....	28
4.2.1.2	Increase or Decrease a Setpoint by a Specified Value.....	28
4.3	Select a Language.....	29
4.4	Print to a File.....	30
4.4.1	Print Report Descriptions.....	31
4.5	Online Help.....	33
Chapter 5:	Security and Administration.....	35
5.1	User Management and Security Screens.....	35
5.1.1	Set User Roles.....	35
5.1.2	Set Screen Security.....	38
5.1.2.1	Screen Security - Main 1 Screen.....	38
5.1.2.2	Screen Security - Main 2 Screen.....	40
5.1.2.3	Screen Security - Heats Page 1 Screen.....	41
5.1.2.4	Screen Security - Heats Page 2 Screen.....	43
5.1.2.5	Screen Security - Servo Screen.....	44
5.1.3	User Preferences.....	45
5.1.4	Auto Logout.....	45
Chapter 6:	Mold Setups.....	47
6.1	Files Screen.....	47
6.1.1	Make a New Mold Setup Folder.....	49
6.1.2	Make a New Mold Setup File.....	50
6.1.3	Save Changes to a Mold Setup File.....	50
6.1.4	Discard Changes to a Mold Setup File.....	50
6.1.5	Save the Current Mold Setup File as a New File.....	51
6.1.6	Load an Existing Mold Setup File.....	51
6.1.7	Delete Files.....	51
6.1.8	Copy Files.....	51

6.1.9	Rename Files	52
6.1.10	Transfer Data to the Network	52
6.1.11	Transfer Data with a USB Storage Device	52
Chapter 7:	Making Adjustments	53
7.1	Zone Selection	53
7.2	Make a Zone Group	54
7.3	Multi Group View Screen	55
7.3.1	Changing the Header Color	57
7.4	Graphical View Screen	58
7.5	Neo View Screen	61
7.5.1	Simple Screen mode	61
7.5.2	Detailed Screen mode	62
7.5.3	Zone Block Background Color	64
7.5.4	Follower Zone Block	65
7.5.5	Status Abbreviations	65
7.6	Text View Screen	66
7.6.1	Zone Selection in the Text View Screen	68
7.6.2	Sorting	68
7.7	Quick Adjustment Panel	69
7.8	Quick Set Screen	70
7.8.1	Zone Setpoint Fields	70
7.8.1.1	Frequently Used	70
7.8.1.2	Zone Edit	71
7.8.1.3	Setpoint Limits	72
7.8.1.4	Manual Standby	72
7.8.1.5	Manual Boost	73
7.8.1.6	Remote Standby	73
7.8.1.7	Remote Boost	74
7.8.1.8	Advanced Settings	74
7.8.1.9	Control Settings	75
7.8.2	Zone Name	76
7.8.2.1	Multiple Zones Names	77
7.8.3	Temperature Setpoints	78
7.8.4	Alarm Window	78
7.8.5	Abort Window	78
7.8.6	Output Mode	79
7.8.7	Zone Follow	79
7.8.7.1	Automatic Follow Function	79
7.8.7.2	Manually Assign One Zone (Follower) to a Another Zone (Leader)	80
7.8.7.3	Regulation Mode	80

7.8.8	Setpoint Limits	81
7.8.8.1	Change the Normal Setpoint and Limits	81
7.8.8.2	Change the Manual Standby and Remote Standby Setpoint Limits	81
7.8.8.2.1	Change the Manual Standby Setpoint Limits	82
7.8.8.2.2	Change the Remote Standby Setpoint Limits	82
7.8.8.3	Change the Manual Boost Setpoints and Limits	82
7.8.8.4	Change the Remote Boost Setpoints and Limits	83
7.8.9	Change the Sensor Assignment (Thermocouple)	84
7.8.10	Change the Priority Control Mode	84
7.8.11	Change the Earth Leakage Check	85
7.8.12	Change the Automatic Manual Control	85
7.8.13	Change the Output Power Limit Setting	85
7.8.14	Change the Zone Control from ART to PID	86
7.8.14.1	Change P, I or D Parameter Values	86
7.9	Active Reasoning Technology	87
7.9.1	ART Process Screen	87
7.9.1.1	Manual ART Function	89
7.9.2	ART 2.0	90
7.10	PID Control	92
7.10.1	Typical PID Values	92
7.10.2	Possible Causes of Oscillation	92
Chapter 8:	Mold Diagnostics	93
8.1	Testing the Mold	93
8.1.1	Run a Mold Diagnostics Test	95
8.1.2	Set the Zone Cooling Time	95
8.1.3	Set the Maximum Test Time	96
8.2	Diagnostics Results	96
8.2.1	Test Results Screen Values	97
8.2.2	Automatic Thermocouple Rewiring	99
8.3	Cross Talk Screen	99
8.4	Temperature Graphs Screen	100
Chapter 9:	Heat the Mold	103
9.1	Heater Circuit Test	103
9.1.1	Startup	103
9.2	Earth Leakage/Wet Heater Bake Out System	104
9.2.1	Earth Leakage Limit	104
9.2.1.1	Set the Earth Leakage Limit	104
9.2.2	Configure the Length and Number of Bake Out Cycles	105
9.3	AltaStart	105
9.4	UniStart	106
9.5	Fast Heating	106

9.6	Soft Start	107
9.6.1	Enable Soft Start.....	107
9.6.2	Disable Soft Start.....	107
9.6.3	Adjust the Soft Start Minimum Limit	108
9.7	Alarms Screen.....	108
9.7.1	Open the Alarms Screen	109
9.7.2	Alarm States	109
9.7.3	Clear Alarms.....	110
9.8	Event History Screen	110
9.8.1	Filter Events.....	111
9.9	Alarm and Event Icons.....	112
9.10	Alarm Conditions — Warning Errors	113
9.11	Abort Conditions — Shutdown Errors.....	114
Chapter 10:	System Setup	117
10.1	System Setup - Main 1 and Main 2 Settings.....	118
10.2	System Setup - Network Settings	120
10.2.1	Wired Network	121
10.2.2	Wireless Network.....	122
10.2.3	Network Share	123
10.2.4	Dashboard Interface.....	125
10.2.5	Remote Service Assistance.....	126
10.2.5.1	Proxy Settings	126
10.2.5.2	Start a TeamViewer Session	127
10.2.6	Virtual Network Computing.....	127
10.2.6.1	VNC Client.....	129
10.2.6.2	VNC Server	129
10.2.6.3	VNC Connection.....	129
10.2.7	OPC UA Interface.....	130
10.2.7.1	OPC UA Interface Enable.....	131
10.2.7.2	Certificates	132
10.2.8	ShotscopeNX.....	134
10.2.9	Network Diagnostics	134
10.2.10	Time Synchronization	135
10.3	System Setup - Heats Settings	137
10.3.1	Heats Setup - Control Page 1.....	138
10.3.2	Heats Setup - Control Page 2.....	141
10.3.3	Heats Setup - Control Page 3.....	142
10.3.4	Heats Setup - Monitoring 1 and Monitoring 2.....	144
10.4	Force Temperature Units To	148
10.5	Units of Measure	148
10.6	Equipment Protection.....	148
10.7	Power Conservation.....	149

10.8	Part Counting	149
10.8.1	Set Part Counting	149
10.8.2	Reset the Part Counter.....	150
10.8.3	Sack Full Output Optimization	150
10.9	Remote Load	152
10.10	Grid Size and the Group Offset	154
10.11	Zone Alarm Control	154
10.12	Monitor Zone Settings	155
10.13	Power Limiting.....	155
10.14	Power Deviation	155
10.15	Current Deviation	157
10.16	No Heater Detection	157
10.17	Energy Usage and Units	158
10.18	Number of Zones in the System	158
10.19	Standby Timer Settings	159
10.19.1	Set the Manual Standby Duration Timer.....	159
10.19.2	Set the Remote Standby Duration Timer	160
10.19.3	Set the Remote Standby Delay Timer.....	160
10.19.4	Set the Remote Standby Input Mode.....	161
10.19.5	Standby Operation Description	161
10.20	Boost Timer Settings	163
10.20.1	Set the Manual Boost Duration Timer	163
10.20.2	Set the Remote Boost Duration Timer	163
10.20.3	Set the Remote Boost Delay Timer	163
10.20.4	Change the Remote Boost Input Mode.....	164
10.20.5	Boost Operation Description.....	164
10.21	Resin Protection Timer	165
10.21.1	Set the Resin Degradation Limit.....	166
10.21.2	Set the Cycle Idle Time Limit	166
10.21.3	Set the Cycle Idle Reaction.....	166
10.22	Auto Power Limiting	167
10.23	Options and Licensing	167
10.24	Diagnostics Export	169
10.25	Mold Cooling Enable.....	169
10.26	Staged Startup and Shutdown.....	169
10.26.1	Staging Screen	170
10.26.2	Enable/Disable Staged Startup.....	171
10.26.3	Enable or Disable Staged Shutdown	172
10.26.4	Set the Staged Temperature and Power Setpoints	172
10.26.5	Hold a Stage Setpoint	172
10.26.6	Set the Soak Timers	173
10.27	Supply Voltage Screen	173
10.27.1	Configure the Supply Voltage.....	176

Chapter 11: Mold Picture View	177
11.1 Mold Picture View Graphic	177
11.1.1 Map a Network Drive	177
11.1.2 Load a Mold Picture View Graphic.....	178
11.2 Mold Picture View Toolbar.....	180
11.3 Configure a Mold Picture View.....	181
11.3.1 Edit Mode.....	181
11.3.2 Zone Information Panels.....	181
11.3.2.1 Make a Zone Information Panel	182
11.3.2.2 Move a Zone Information Panel	182
11.3.2.3 Edit a Zone Information Panel.....	183
11.3.2.4 Make a Leader Line	184
11.3.2.5 Change the Color of a Leader Line.....	184
11.3.2.6 Change the Thickness of a Leader Line	184
11.3.2.7 Delete a Leader Line	185
11.3.2.8 Delete a Zone Information Panel	185
11.3.3 Exit Edit Mode.....	185
Chapter 12: Data Recording	187
12.1 Trend Plot Screen	187
12.1.1 Set the Trend Plot	187
12.2 History Plot Screen	189
12.2.1 Curve Data Point	190
12.2.2 Set the Timeframe.....	191
12.2.3 Set the Date and Time Range	191
12.2.3.1 Change the Date and Time Range Old.....	191
12.2.3.2 Change the Date and Time Range New.....	191
12.2.4 Change the Zone Shown on the History Plot Screen	192
12.3 Process Limits Screen	193
12.3.1 Target Settings.....	195
12.3.2 Global Settings.....	196
12.3.3 Delay Limit Check	196
12.3.4 Process Variable Selector	196
12.4 Process Monitoring Setup	198
12.4.1 Time Mode Configuration	198
12.4.2 Cool Down Data Collection	199
12.4.3 Cycle Mode Configuration	199
12.4.3.1 Data Collection Start Conditions	200
12.4.3.2 Data Collection Stop Conditions.....	201
12.4.3.3 Cycle Input (Heat Control Only)	208
12.4.4 Process Monitoring Status	208
12.4.5 Process Log Transfer.....	208

12.4.6	Process Data Filter.....	208
12.4.7	Save Process Data Setup.....	209
Chapter 13: Color Change.....		211
13.1	Color Change Screen.....	212
13.1.1	Ultra Purge Settings Panel	213
13.1.2	Ultra Purge Sequence Panel	213
13.1.3	Ultra Purge Mode Buttons and Status	214
13.1.4	Color Change Settings Panel.....	214
13.2	Cycle Input Connection	215
13.3	Start the Ultra Purge Process	215
13.4	Ultra Purge Process Sequences	216
13.4.1	Color Change and Non-Thermal Sensitive Resin	216
13.4.1.1	Color Change and Non-Thermal Sensitive Resin Example	217
13.4.2	Color Change and Thermal Sensitive Resin	225
13.4.2.1	Color Change and Thermal Sensitive Resin Example	226
13.4.3	No Color Change	234
13.4.3.1	No Color Change Example	234
Chapter 14: System Options.....		243
14.1	Digital I/O	243
14.1.1	Enable an I/O Option	244
14.2	Safety Signals (UltraSync-E or Altanium Servo Control Installed)	244
14.3	Digital Inputs	245
14.3.1	Servo Digital Inputs	245
14.3.2	Heats Digital Inputs	246
14.4	Digital Outputs	248
14.4.1	Servo Digital Outputs.....	248
14.4.2	Heats Digital Outputs.....	251
14.5	Configurable Signals (UltraSync-E, Altanium Servo Control, or Valve Gate Sequencer Installed)	253
14.5.1	Logic Function	254
14.5.2	Force	255
14.5.3	Conditions	255
14.6	Cable Connections.....	255
14.7	Input/Output Connector Pin-Out Description	257
14.7.1	Input Base Connector ID.....	257
14.7.2	Output Base Connector ID	257
14.7.3	Part Count Base Connector ID.....	259
14.7.4	Remote Load Base Connector ID	259

Chapter 15: SPI Protocol Option	261
15.1 SPI Command Summary.....	261
15.1.1 Echo	261
15.1.2 Process Setpoint	262
15.1.3 Process Value	262
15.1.4 Alarm Active Status.....	262
15.1.5 Alarm 1 Setpoint	263
15.1.6 Alarm 2 Setpoint	263
15.1.7 Alarm 1 Reset	263
15.1.8 Controller Status	264
15.1.9 Manual Percent Output.....	265
15.1.10 Open/Closed Loop	265
Chapter 16: Maintenance	267
16.1 Delta5 System	267
16.2 Card Layout Screen	269
16.2.1 Troubleshooting with the Card Layout Screen	270
16.3 Intelligent Control Cards	272
16.3.1 Replace an Intelligent Control Card (ICC2 or ICC3)	274
16.3.2 Replace an Open Fuse on an Intelligent Control Card	276
16.4 Delta5 Operator Interface	278
16.4.1 Remove and Replace the Touch Monitor	280
16.4.2 Remove and Replace the MCU	284
16.4.3 Remove and Replace the Operator Interface.....	288
16.4.4 Install the Remote Operator Interface	291
16.4.5 Install the Alternative Mounted Operator Interface	296
16.4.6 Install the Dual Touch Monitor.....	300
16.5 Thermocouple Calibration.....	306
16.6 Clean the System.....	309
16.6.1 Cabinet (Mainframe).....	309
16.6.2 Touch Monitor	309
16.7 Basic Troubleshooting.....	310
16.8 Failure Causes and Solutions	313
16.8.1 Supported Electrical Failures.....	314
Appendix A: Glossary of Terms	317
Index	319

Chapter 1 Introduction

This User Guide includes general warnings and cautions to avoid injury to personnel and damage to the system. These warnings and cautions are not intended to be, nor are they all-inclusive to every condition or application that may occur during operation. Maintenance and safety procedures remain the sole responsibility of the individual and his or her company.



IMPORTANT!

Some manuals may contain addendums that detail new or updated information. Before reading a manual, make sure to review all available addendums located at the end of the manual.

1.1 General Safety



WARNING!

Electrical shock risk - de-energize controller prior to connecting, disconnecting or servicing the controller, hot runner or mold.



WARNING!

Electrical hazard - risk of shock or personal injury. ALWAYS make sure that the screw on the back of the top portion of the controller, marked with the general warning symbol, is installed when the controller is energized. This is the grounding point for the top cover to the chassis. Removal of this screw could cause an unsafe condition unless proper precautions are taken, such as Lock Out Tag Out (LOTO).



WARNING!

Gas/vapor hazard – risk of respiratory injury. Certain processed materials could release harmful gas, vapors or dust. Install an exhaust system according to local codes. Plastic degrades with prolonged exposure to the setpoint temperature. Do not leave machine and controller unattended.

- The system must be installed by qualified personnel only, in accordance with local codes.
- When the controller is connected to an injection molding machine, the safety of the system is the responsibility of the integrator.
- Only persons with a full knowledge of the system's operation and capabilities should operate the system.
- Read all of these instructions before power is connected and the system is energized.
- Follow all warnings and instructions marked on the system.
- Unless specifically explained in this manual or directed by Husky, do not attempt to repair the system. To do so can result in damage to the system, or serious personal injury.
- Only use the specified input supply voltage that is indicated on the identification label attached to the power input cable and/or the cabinet.

NOTE: If you are not sure of the applicable supply voltage, call the nearest Husky Regional Service and Sales office.

CAUTION!

Mechanical hazard - risk of damage to the equipment. NEVER let the fan inlets or outlets on the unit to become blocked. This is where the system's cooling airflow enters and exits. If this area of the mainframe becomes cluttered and insufficient airflow results, damage may occur to the system.

CAUTION!



When the system is turned OFF, wait 30 seconds before the system is turned ON again. If you do not wait the necessary 30 seconds, communication issues can occur.

1.1.1 Safety Signs

Safety signs clearly mark potentially hazardous areas in or around equipment. For the safety of personnel involved in equipment installation, operation, and maintenance, use the following guidelines:

The following safety symbol may appear on safety signs:

NOTE: Safety signs may include a detailed explanation of the potential hazard and associated consequences.

Safety Symbol	General Description of Symbol
	General This symbol indicates a potential personal injury hazard. It is usually accompanied by another pictogram or text to describe the hazard.
	Hazardous Voltage This symbol indicates a potential hazard that may cause death or serious injury and will appear on any panel that, if removed, will expose the user to more than 40 VAC.

1.2 Purpose of the Equipment

Husky controllers are designed to control the process temperature for injection molding applications only.

Contact your nearest Husky Regional Service and Sales office if you plan to use a Husky product for anything other than its intended use.

1.3 Restrictions of Use

Husky injection molding equipment must never be:

- Used for any purpose other than that described in [Section 1.2](#), unless otherwise approved by Husky
- Operated or serviced by personnel unfamiliar with the inherent risks and necessary precautions related to controllers

1.4 Input Wiring (Conventional)

[Table 1-1](#) summarizes the wiring conventions used.

Table 1-1 Electrical Wire Standards

Description	Wire Color	
Neutral	Blue	
Earth/Ground	Green/Yellow	Green
Line	Black	
Line	Brown	Red
Line	Gray	White



DANGER!

Electrocution and/or mechanical hazard - risk of death or serious injury and possible damage to the equipment.

Incorrectly wiring the controller could cause death or serious injury and/or damage to the controller or hot runner. Only qualified personnel should connect the electrical power supply. All work must conform to applicable local electrical codes.

1.5 Environmental Operating Specifications

The list that follows shows the environmental operation specifications for the Altanium Delta5 operator interface:

CAUTION!

Mechanical hazard – risk of equipment damage. Falling or spraying liquid, including oil or water, could damage the equipment. Do not spray wash.

- For Indoor use only.
- Operating Temperature: 5 to 40 °C (41 to 104 °F)
- Operating Humidity: 0% to 90% RH, Non-Condensing
- Altitude: up to 2000 m (6562 ft)
- Pollution Degree: PD2
- Overvoltage Category: OVIII

1.6 Equipment Ratings

Ratings for the entire Altanium Controller can be found on the nameplate attached to the back of the controller.

The following are the equipment ratings for the Altanium Delta5 operator interface only:

- Supply Voltage: 100 to 240 VAC ±10%, single phase
- Frequency: 47 to 63 Hz
- Power Rating: 130 W typical

1.7 Technical Specifications

The dimensions and weight of the controller can change based on the controller configuration.

What follows are the technical specifications for the Altanium Delta5 operator interface only:

Dimensions	Weight
<ul style="list-style-type: none"> • Width: 330 mm (13 in) • Length: 280 mm (11 in) • Height: 380 mm (15 in) 	<ul style="list-style-type: none"> • Controller: 6.8 kg (15 lb) • With shipping container: 10 kg (22 lb)

1.8 Controller Lifting Instructions

Use the steps that follow when you lift the Altanium controller. The lift device (crane or forklift) and straps that are used vary in lifting ability and lengths, depending on whether the Altanium is a single, double, or triple stack controller. [Table 1-2](#) shows the correct lifting ability and lengths.

Table 1-2 Controller Lift Information

Altanium Controller	Webbed Straps Rated 2903 kg (6400 lb)	Ratchet Strap	Lifting Device (Lifting Ability)
Single Stack	Two, 2.44 m x 25.4 mm (8 ft x 1 in.)	One, 1.52 m (5 ft)	227 kg (500 lb)
Double Stack	Two, 3.66 m x 25.4 mm (12 ft x 1 in.)	One, 1.83 m (6 ft)	454 kg (1000 lb)
Triple Stack	Two, 3.66 m x 25.4 mm (12 ft x 1 in.)	One, 2.44 m (8 ft)	907 kg (2000 lb)

1. Put each of the webbed straps under the controller. See the table for the correct strap lengths.
 - a. For single stack controllers, the webbed straps go under the equipment from left to right.
 - b. For double and triple stack controllers, the webbed straps go under the equipment from front to back.
2. Bring the straps up and above the Altanium controller and attach them to the lifting device. Refer to [Figure 1-1](#).

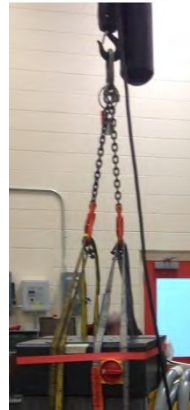


Figure 1-1 Attach Straps to Lift Device

- a. Make sure that the straps are put between the caster wheels and the retaining brackets under the base of the controller. Refer to [Figure 1-2](#).

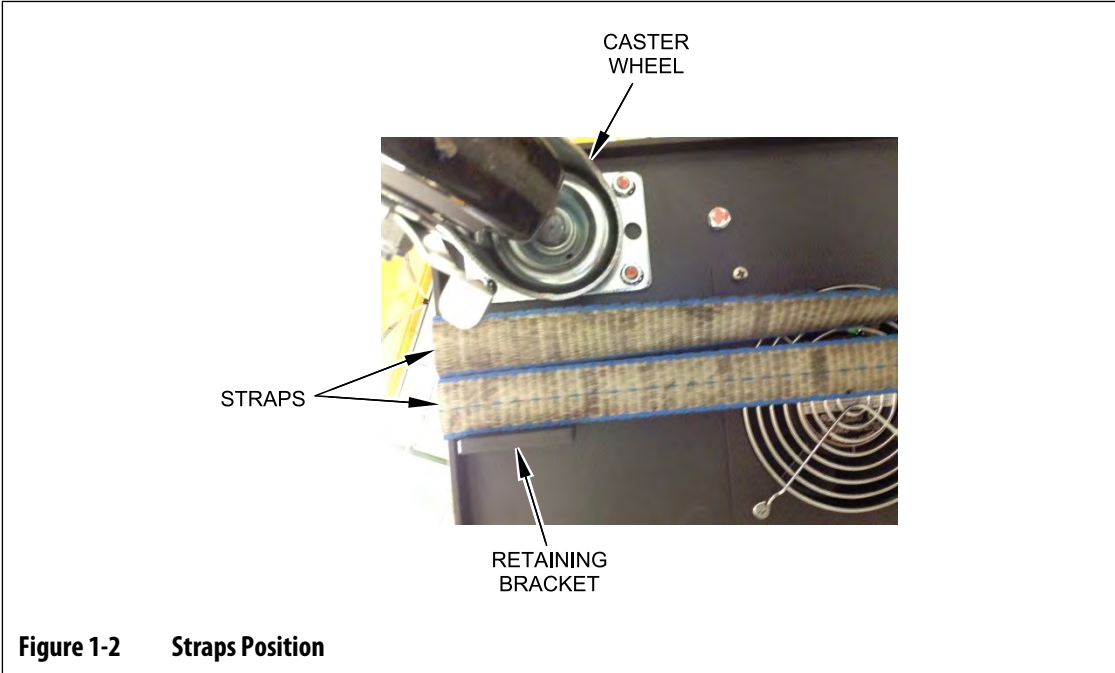


Figure 1-2 Straps Position

- b.** Make sure that the straps do not pinch or crush the cables attached to the controller. Refer to [Figure 1-3](#).

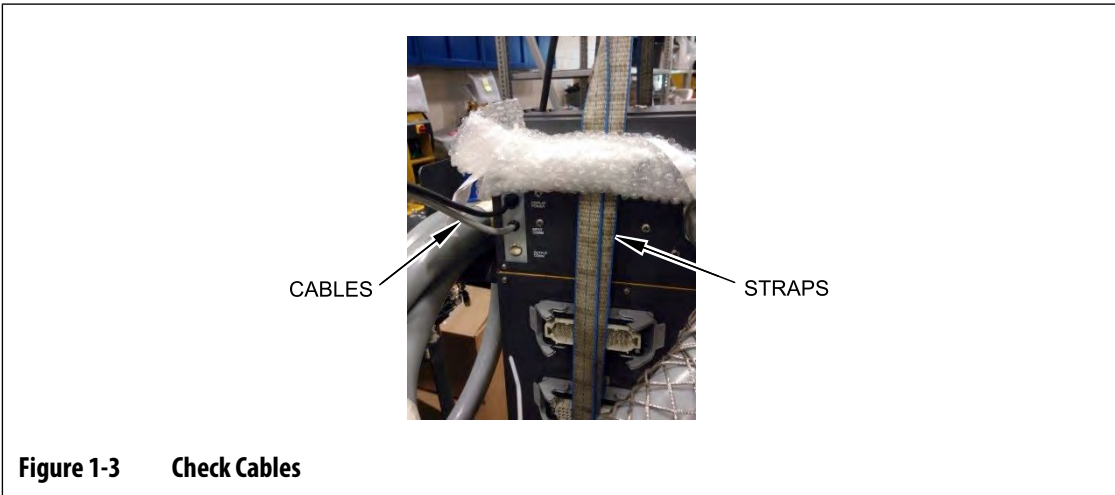
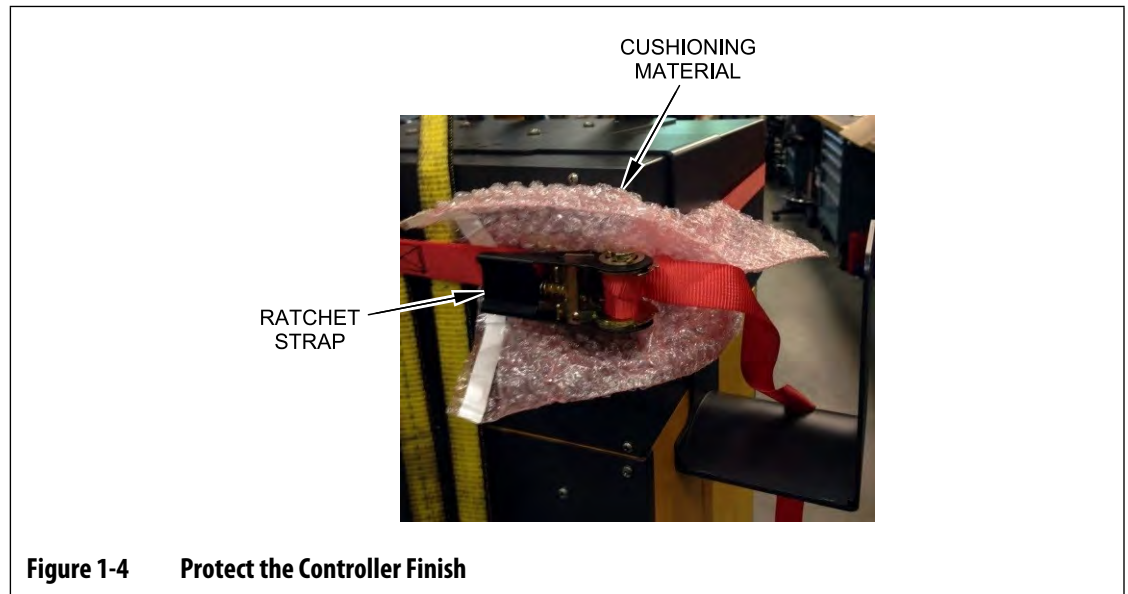


Figure 1-3 Check Cables

- 3.** Use the lift device to apply enough upward force on the straps to remove the slack, but do not lift the controller at this time.
- 4.** Place the ratchet strap around top of the controller, while you hold the four ends of the webbed straps. Do not tighten the ratchet strap at this time.
 - NOTE:** The ratchet strap makes sure that the controller does not tilt when the controller is lifted.
- 5.** Place cloth or other cushioned material between the ratchet strap and the controller to keep the finish of the controller free from rubs and scratches. Refer to [Figure 1-4](#).



6. Tighten the ratchet strap.
7. Use the lift device to slowly lift the controller off the ground a few inches.
8. Examine the webbed straps and ratchet straps to make sure the controller will not tilt.
9. Move the controller to the new location.
10. At the new location, slowly lower the controller to the ground. Continue to lower the lift device until there is no tension in the webbed straps.
11. Remove the ratchet straps, cushioned material, and webbed straps from the controller.

Chapter 2 Hot Runner Temperature Control

This guide is written to make sure that users get the maximum possible benefit from the use of the Altanium Hot Runner Control Systems.

The Altanium controllers were designed as a processor's tool for hot runner molding. The fundamental criteria necessary to operate a hot runner mold is to control the process temperature so that it is as consistent and repeatable as possible with respect to the process setpoint. The closer to the setpoint at which the process temperature is maintained, the lower the setpoint temperature can be set. The results are less cooling time required (energy in - energy out), and faster cycle times.

2.1 Types of Temperature Control

The Altanium controller uses two basic types of control:

- Open loop control with no thermocouple feedback.
- Closed loop control with thermocouple feedback. Closed loop can be sub-categorized as follows:
 - Internal Thermocouple - Located inside and as part of the heater assembly.
 - External Thermocouple - Located close to, but not actually part of a single heater assembly, and can also be allocated to a group of heaters to form a zone.

2.1.1 Open Loop Control

Without a thermocouple, it is not possible to control the temperature inside the mold, only the amount of power supplied to the heater. The Altanium keeps an accurate power output with a resolution of 0.1%. This method of control is called manual regulation.

Open loop control is usually associated with tip heaters, where the physical size of the tip precludes the use of an internal thermocouple.

2.2 Configuring Zones

In an effort to match the energy input requirements of different types of loads, it is necessary for the output power supplied to the heaters to be adjusted over a range of 0 to 100%. The Altanium controller can be set to do this with the use of Zero Cross Control or Phase Angle Control.

2.2.1 Configure a Zone for Zero Cross Control

This method defines how the power to each heater is averaged over a period of time. This is done by switching between complete half cycles of the heater supply voltage with the use of a snubberless TRIAC as a switch device.

2.2.2 Configure a Zone for Phase Angle Control

This method defines how the power to each heater is adjusted, by varying the point in each half cycle at which the snubberless TRIAC (switching device) is turned on.

In either control method, the Altanium controller recalculates the power output requirements for the entire system every 250 milliseconds to get the maximum control resolution. Combine one or the other control methods above with the Active Reasoning Technology (ART) control algorithm, and it is possible to get accurate temperature control with the expectation of control accuracy of ± 1 digit under steady state conditions.

2.3 Determine the Heater Size

Hot runner molds can have different types of heat elements:

- Integral, which is a part of the probe.
- Cartridge, which is slid into the probe or directly into the mold steel.

In the manifold, a series of cartridge heaters or bent tubular style heaters are normally used.

The typical wire used inside an element is made of nickel-chrome, which is surrounded by magnesium oxide. The size of this wire and number of turns determine its resistance, which in turn determines its wattage (the amount of energy). This determines its performance in the mold. Undersize heating elements (too little wattage) create a serious problem when the controller asks for power and none is available. In almost all cases it is better to be oversized than undersize in a hot runner mold.

The Altanium controller provides wattage, resistance, or amperage information for heaters, if equipped with X ICC² or X ICC³ cards. This information can also be calculated with the use of Ohm's Law. The steps and formulas that follow show how.



WARNING!

Electrical hazard— risk of death or serious injury. Disconnect all electrical power from the mold and controller prior to performing this test.

1. On a multimeter, set the selector to measure resistance.
2. Place the (red) positive lead onto the first wire from the heating element and place the (black) negative lead from the meter onto the second wire.

NOTE: These may be pins on a connector, or the zone output fuses in the system as long as they are connected to the heating element.

The meter will show a resistance in ohms.

3. Record the measurement.
4. Use Ohm’s Law to calculate the results.

Ohm's Law says:

$$\text{Amps} = \text{Watts} / \text{Volts}$$

$$\text{Amps} = \text{Volts} / \text{Resistance}$$

$$\text{Resistance} = \text{Volts} / \text{Amps}$$

$$\text{Watts} = \text{Volts} \times \text{Amps}$$

Example: If the resistance is 12.5 ohms and the input voltage is 240 volts, divide 240 by 12.5 to calculate the maximum amperage draw on that heating element:

$$240 / 12.5 = 19.2 \text{ amps}$$

$$19.2 \text{ Amps} \times 240 \text{ volts} = 4,608 \text{ watts.}$$

In hot runner molding, some portions of Ohm's law are more useful than others. Shown here are only those laws that are necessary.

Input voltage	24 V	110 V	208 V	220 V	240 V
Resistance	20 Ω	20 Ω	20 Ω	20 Ω	20 Ω
Amperage	1.2 A	5.5 A	10.4 A	11.0 A	12.0 A
Watts	28.8 W	605.0 W	2163.2 W	2420 W	2880 W

2.4 Thermocouple Types and Color Codes

Altanium controllers use the ANSI color code for all thermocouples. [Table 2-1](#) is a reference for hot runners and cables that follow other color code standards.

Table 2-1 Thermocouple Types and Color Codes

Code	Type	International Color Code (BS4937 Part 30:1993)	BRITISH (BS1843:1952)	U.S. ANSI	GERMAN DIN
J	Iron/ Constantan/ (Copper-Nickel)	Overall Black	Overall Black	Overall Black	Overall Blue
		+ ve - ve Black White	+ ve - ve Yellow Blue	+ ve - ve White Red	+ ve - ve Red Blue
K	Nickel-Chromium/ Nickel- Aluminum	Overall Green	Overall Red	Overall Yellow	Overall Green
		+ ve - ve Green White	+ ve - ve Brown Blue	+ ve - ve Yellow Red	+ ve - ve Red Green

Chapter 3 Connect the System to the Mold

This chapter gives the various checks to make before you energize the system.

3.1 Before Startup



DANGER!

Electrocution hazard— contact with hazardous voltages will cause death or serious injury. Make sure that the system is completely disconnected from the power source.

- Clean up any water, oil, dirt, cleaning fluids etc. that may have spilled during a mold change or since the last production run.
- Make sure the display module is mounted to either the controller or remotely. For more information, refer to [Section 16.4.3](#) or [Section 16.4.4](#).
- Make sure the cooling fan is free from obstructions.
- Check all of the cable connections between the system and the mold (if required). Make sure all of the cables are free from wear or damage.
- Check that the earth/ground connection is in good condition. Verify the system and the mold have the same ground reference.

3.2 Connect to the Power Source

To connect the power source, do the steps that follow:



DANGER!

Electrocution hazard— contact with hazardous voltages will cause death or serious injury. Make sure that the system is completely disconnected from the power source.

1. Connect the thermocouple and power output cables (if required).
2. With an ohmmeter, touch one test lead to the mold and the other to the mold ground terminal on the system. Resistance must be less than 1 Ω .
3. Make sure that the main input power disconnect is in the OFF position.
4. Connect the controller to the power source.

3.3 Startup Procedure Checklist

To energize the controller, do the tasks in the checklist that follows in order:

Item	Step	✓
1	Connect power/thermocouple cables between the mold and controller (if required).	
2	Connect the I/O box or option cables (if required).	
3	Connect the controller to the power source.	
4	Set the controller power switch to the ON position.	
5	Login to the system (if required).	
6	Select the required mold setup.	
7	Make sure that the mold setup is the correct one. Do a check of the name and setpoints in the preview window.	
8	Correct any faults found during diagnostics.	
9	Touch START to run the system.	
10	Make sure that the controller operates correctly. Monitor the Graphical View and Text View screens.	

NOTE: There are no controller-to-mold interconnection details included in this User Guide. If this information is necessary, please call the nearest Husky Regional Service and Sales office.



IMPORTANT!

If you turn off the system, wait 30 seconds before you turn the main disconnect switch back on. If the system is turned off and on incorrectly can result in system communication problems.

Chapter 4 Altanium Operator Interface

This chapter gives an overview of the functionality of the Altanium system and gives information about the topics that follow:

- Altanium operator interface
- Altanium buttons
- Altanium status
- Language selection

4.1 General

The operator interface is a touch-sensitive display screen that is supported on a pedestal with the controller module. Together, they are mounted onto the Altanium mainframe or a remote mount, if ordered.

4.1.1 Altanium Operator Interface

The Altanium operator interface is a high-resolution color LCD display covered by a transparent touch screen. The display's high definition and wide angle of view makes the screen easy to see in good and poor lighting conditions.

CAUTION!

Mechanical hazard – risk of equipment damage. Use a finger to operate the touch screen. Do not use a screwdriver, pen, or other tool to touch the screen as this can damage the touch screen.

Use the touch screen to change settings on the Altanium operator interface.

4.1.2 Home Screen

From the Home screen you can navigate to all other screens in the system. The Home screen can be accessed from all other screens in the system when you touch the Home button in the system header. The system screen selections on the Home screen are organized into groups: Servo Control, Temperature Control Views, Temperature Control, Common, and System Configuration screens. Refer to [Figure 4-1](#).

Because of the features installed or not installed on your Altanium system, your Home screen and other screens can look different from the screens shown in this user guide.

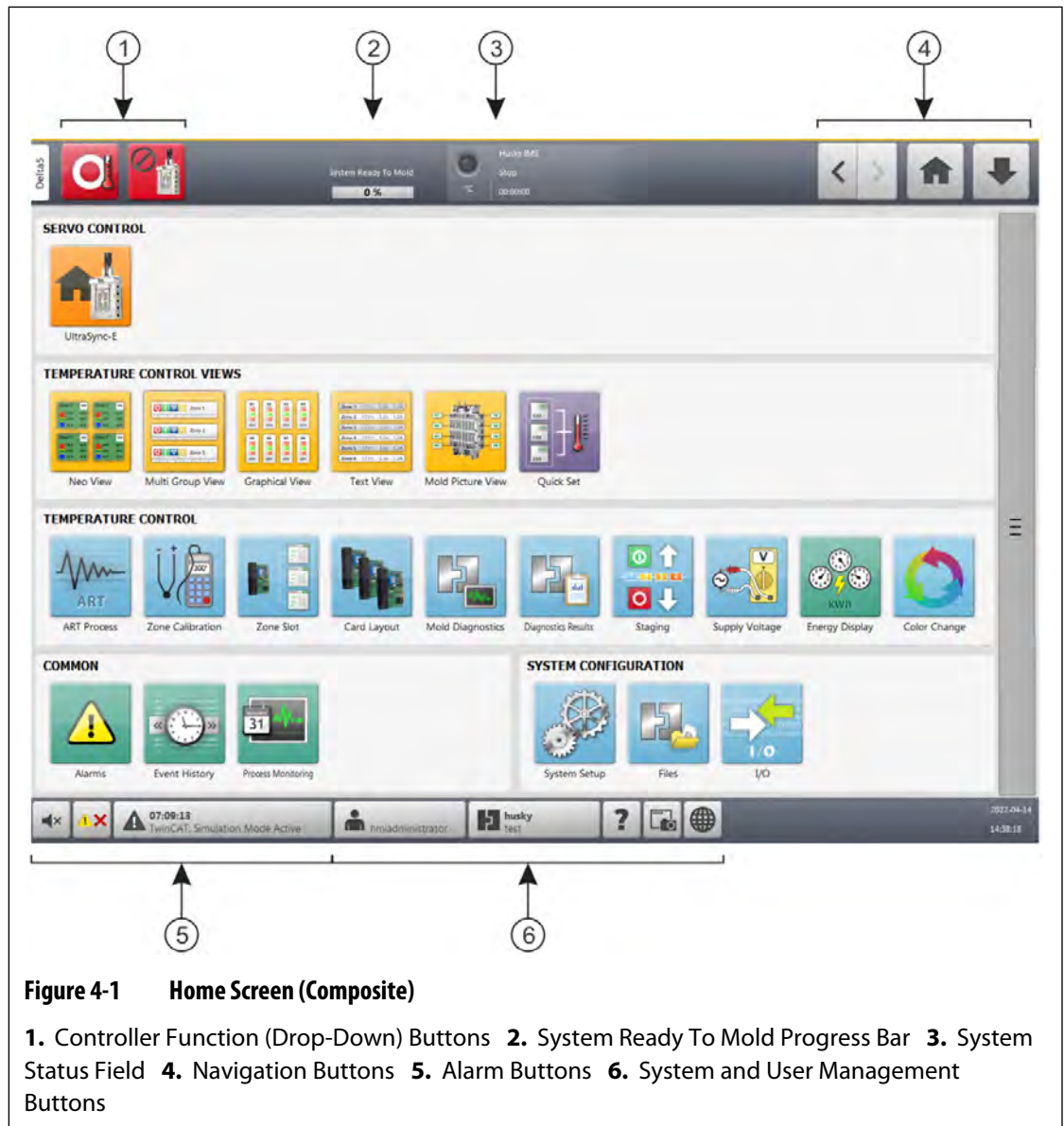


Figure 4-1 Home Screen (Composite)

- 1.** Controller Function (Drop-Down) Buttons
- 2.** System Ready To Mold Progress Bar
- 3.** System Status Field
- 4.** Navigation Buttons
- 5.** Alarm Buttons
- 6.** System and User Management Buttons





4.1.3 Altanium Buttons

Altanium has a system header and a footer on every screen in the system.

4.1.3.1 Controller Function Buttons

Refer to [Figure 4-1](#) for the Controller Function buttons location. [Table 4-1](#) describes the button functions.

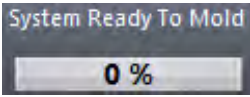
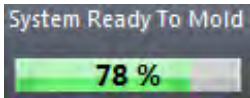

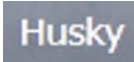
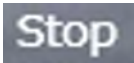
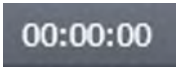
Table 4-1 Controller Function Buttons

Button	Description
	<p>Stop</p> <p>Stops the power to all zones. This stops the power in all system conditions.</p>
	<p>Start</p> <p>Applies power to the zones that have a configured setpoint.</p>
	<p>Standby</p> <p>Puts the system in standby mode. If a timer is active, the time remaining is shown in the status bar. This button is not available during Active Reasoning Technology (ART) tuning.</p>
	<p>Boost</p> <p>Puts the system in boost mode. If a timer is active, the time remaining is shown in the status bar. This button is not available during ART.</p>

4.1.3.2 System Status Field

Refer to [Figure 4-1](#) for the System Status field location. [Table 4-2](#) describes the System Status Field information.

Table 4-2 System Status Field

Button	Description
 	<p>System Ready To Mold</p> <p>When the system starts, this status bar shows the progress as the mold zones heat to the At Temperature setpoint. The status bar and label do not show after the zones get to the At Temperature setpoint.</p>
	<p>At Temperature</p> <p>This gives an indication of what follows:</p> <ul style="list-style-type: none"> Flashes while the controller applies heat to the zones as they increase in temperature to the setpoint. Solid when all automatic zones are “At temperature”. Off if the controller is in the “Stop” state.
	<p>Company Name</p> <p>The company name is shown.</p>
	<p>System Mode</p> <p>Shows the current mode of the system. For a description of each system mode, refer to Section 4.1.5.</p>
	<p>System Timer</p> <p>Shows the timer value.</p>

4.1.3.3 Navigation Buttons

Refer to [Figure 4-1](#) for the Navigation buttons location. [Table 4-3](#) describes the Navigation button functions.

Table 4-3 Navigation Buttons

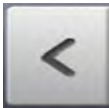
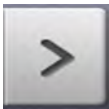


Button	Description
	<p>Back</p> <p>To see the previous screen (maximum of 10 screens back).</p> <p>NOTE: The Home Screen is not included as part of the navigation history.</p>
	<p>Forward</p> <p>To see the next screen (maximum of 10 screens forward).</p> <p>NOTE: The Home Screen is not included as part of the navigation history.</p>



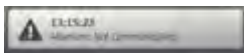
Table 4-3 Navigation Buttons (Continued)

Button	Description
	<p>Home To see the Home screen.</p>
	<p>Quick Navigation To see a drop-down list of view buttons for products that are configured for your system (the I/O button will always show).</p>

4.1.3.4 Alarm Buttons

Refer to [Figure 4-1](#) for the Alarm buttons location. [Table 4-4](#) describes the Alarm button functions.

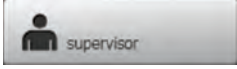


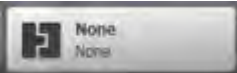

Table 4-4 Alarm Buttons

Button	Description
	<p>Silence Horn Stops the audible alarm.</p>
	<p>Alarm Reset Clears the alarms that have been corrected.</p>
	<p>Alarm Status Shows the Alarm screen. The time and a description of the most important active alarm is shown. If an alarm is active, the Triangle Icon (Warning) changes to yellow and the background of the button flashes red.</p>

4.1.3.5 System and User Management Buttons

Refer to [Figure 4-1](#) for the Alarm buttons location. [Table 4-5](#) describes the System and User Management button functions.




Table 4-5 System and User Management Buttons

Button	Description
	<p>User Log off/ Log on</p> <p>Shows the name of the current user who is logged in. Touch the button to see the User Login dialog window. This button toggles between Login and Logout.</p>
	<p>Help</p> <p>Opens the PDF viewer and see the User Guide on the screen.</p>
	<p>Print</p> <p>Opens the Print dialog window. The window shows the available print selections.</p>
	<p>Files</p> <p>Opens the Files screen for mold setup. The face of the button shows the mold setup information. The upper word is the name of the mold folder. The lower word is the name of the mold setup file.</p>
	<p>Language Selection</p> <p>Lets you select the available screen languages.</p>

4.1.4 Dialog Window Buttons

The buttons in [Table 4-6](#) are available in the Altanium dialog windows.

Table 4-6 Dialog Window Buttons

Button	Description
	<p>Accept (green check mark icon) To accept the changes you made in a dialog window.</p>
	<p>Cancel (red X icon) To discard the changes you made in a dialog window.</p>
	<p>Exit (exit door icon) To close the dialog window.</p>

4.1.5 System Modes

A system mode is always shown at the top of the Altanium screen in the System Status Field. Refer to [Figure 4-1](#) and [Section 4.1.3.2](#). Descriptions of the system modes are given in [Table 4-7](#).

Table 4-7 System Modes

System Mode	Description
Stop	The system is stopped, and no power is applied to the heaters.
Running	The system is in operation. Power is applied to the zones to get to the temperature setpoint(s), or the system maintains the zone temperatures at the setpoint(s).
Manual Standby	The system was put into Manual Standby and the system adjusts the temperature to the manual standby setpoint.
Remote Standby	An external signal has activated the remote standby mode and the system adjusts the temperature to the Remote Standby setpoint.
Delay Standby	The system is delayed for a set duration of time before it changes to Remote Standby mode.
Manual Boost	The system was put into the Manual Boost mode and the system adjusts the temperature to the manual boost setpoint.
Remote Boost	An external signal has activated the remote boost mode and the system adjusts the temperature to the remote boost setpoint.
Delay Boost	The system is delayed for a set duration of time before it changes to Remote Boost mode.

Table 4-7 System Modes (Continued)

System Mode	Description
ART	The Active Reasoning Technology (ART) tuning process is active.
Calibration	Shown during thermocouple input calibration for the zones.
Diagnostics	The mold diagnostics process is active.
Firmware Update	Shown during a firmware update on selected control cards.
Bake Out Cycle 1	Shown as the system is bakes out moisture in the mold. This is the first bake of the mold.
Bake Out Cycle 2	Shown as the system is bakes out moisture in the mold. This is the second bake of the mold.
Bake Out Cycle 3	Shown as the system is bakes out moisture in the mold. This is the third bake of the mold.
Bake Out Cycle 4	Shown as the system is bakes out moisture in the mold. This is the fourth bake of the mold.
Bake Out Cycle 5	Shown as the system is bakes out moisture in the mold. This is the fifth bake of the mold.
Soft Start	The system gradually increases the temperature of all zones to a setpoint in an even process.
Soft Start to Manual Standby	The system was put into Manual Standby while the system was in the Soft Start process.
Soft Start to Remote Standby	During the Soft Start process, an external signal was activated that tells the system to increase the temperature of all zones to the Remote Standby setpoint.
Stage x Active (Heating)	The system increases the temperature to the stage setpoint for all zones assigned to stage x (1-4).
Stage x Active (ART)	The ART tuning process is applied only on the zones assigned to stage x.
Stage x Soaking (Heating)	After the temperature has increased, the system keeps the zones' temperature at the stage x setpoint until the soak timer completes.
Stage x Active (Cooling)	All zones assigned to stage x decrease their temperature to the stage setpoint.
Stage x Soaking (Cooling)	After the temperature has decreased to the stage setpoint, the system keeps the zones' temperature at the stage x setpoint until the soak timer completes.
Stage 4 Running Indefinitely (Heating)	The system stays in stage 4 until the user touches the Start button to increase the temperature(s) of the zones to the operation setpoint.
Bake Out Check	The system examines all zones for bake out conditions. Bake out conditions are not as much of a problem as earth leakage.
Earth Leakage Check	The system examines all zones for earth leakage conditions.
Circuit Test	The system makes sure that there are no heater circuit faults (open circuit, short circuit, leakage, or wrong heater) on all zones.




4.1.6 Servo Control

The Servo Control panel of the Altanium Home screen gives access to installed systems, such as the UltraSync-E, the UltraShot, or the Altanium Servo Controller. Refer to the appropriate user guides for more information.

Table 4-8 shows the buttons for the available options that could be installed on your Altanium system.

NOTE: The Servo Control panel will be empty if no other systems are installed.

Table 4-8 Servo Control Options

Button	Description
	<p>UltraSync-E For more information, refer to the UltraSync-E User Guide.</p>
	<p>UltraShot Controller For more information, refer to the UltraShot Controller User Guide.</p>
	<p>Altanium Servo Controller For more information, refer to the Altanium Servo Controller User Guide.</p>

4.1.7 Temperature Control Views

The Temperature Control Views panel of the Altanium Home screen gives access to zone data in different formats. Touch a view button to open the related screen. Table 4-9 gives a description of the view screens.

Table 4-9 Temperature Control Views Buttons







View Button	Description
	<p>Neo View Shows the zones shown in a block format. This screen gives an easy, overall status view of the mold, so you do not have to sort through much data.</p>
	<p>Multi Group View Shows the zones organized into groups. This screen lets the user have control of each group. Refer to Section 7.3 for more information.</p>
	<p>Graphical View Shows a graphical view of zone data. Refer to Section 7.4 for information.</p>

Table 4-9 Temperature Control Views Buttons (Continued)

View Button	Description
	<p>Text View</p> <p>Shows a textual view of zone data. Refer to Section 7.6 for more information.</p>
	<p>Mold Picture View</p> <p>Shows an image (picture or graphic) of the mold or hot runner system layout from an imported image file. Refer to Chapter 11 for information.</p>
	<p>Quick Set</p> <p>Used to assign zones into groups and configure setpoints. Refer to Section 7.8 for information.</p>

4.1.8 Temperature Control

The Temperature Control panel of the Altanium Home screen gives access to the screens used for zone temperature control, calibration, mold diagnostics, staging, and more. [Table 4-10](#) gives a description for each of the related screens for the temperature control buttons.

Table 4-10 Temperature Control Buttons










View Button	Description
	<p>ART Process</p> <p>To use and monitor the Active Reasoning Technology (ART) self-tuning process. Refer to Section 7.9.1 for information about the ART process.</p>
	<p>Zone Calibration</p> <p>Shows the screen used to calibrate the zone thermocouples. Refer to Section 16.5 for more information.</p>
	<p>Zone Slot</p> <p>Shows the Zone Slot Configuration screen.</p>
	<p>Card Layout</p> <p>Shows the Card Layout screen, which identifies the controller cards in the mainframe. The cards are shown with the zones they control. Refer to Section 16.2 for information.</p>
	<p>Mold Diagnostics</p> <p>Used to troubleshoot problems with a mold or to make sure that the wiring integrity of a mold after maintenance has been done. Refer to Chapter 8 for information.</p>




Table 4-10 Temperature Control Buttons (Continued)

View Button	Description
	<p>Diagnostic Results</p> <p>Shows the results of the mold diagnostics. Refer to Section 8.2 for information.</p>
	<p>Staging</p> <p>Used to heat or cool zones in a specified order with the use of stages. From the Staging screen a user can assign zones to stages, set stage setpoints, and enter soak timers for each stage. Refer to Section 10.26.1 for information.</p>
	<p>Supply Voltage</p> <p>Shows a graphical view of the phase pairs by the Supply Configuration parameter selected in the System Setup screen. Refer to Section 10.27 for information.</p>
	<p>Energy Display</p> <p>Shows the system real-time energy accumulation data. Refer to Section 10.17 for information.</p>

4.1.9 Common Buttons

The Common panel of the Altanium Home screen gives access to the screens used for the alarms, event history, and process monitoring. [Table 4-11](#) gives a description for each of the related screens for the Common buttons.




Table 4-11 Common Buttons

Button	Description
	<p>Alarms</p> <p>Shows a list of alarms that have occurred. Refer to Section 9.7 for information.</p>
	<p>Event History</p> <p>Shows a list of the operations done at the Altanium screen. Refer to Section 9.8 for information.</p>
	<p>Process Monitoring</p> <p>Shows the screens used for graphical trend and history plots, enter zone target settings, and other specifications. Refer to Chapter 12 for information.</p>

4.1.10 System Configuration Buttons

The System Configuration panel of the Altanium Home screen gives access to the system setup, mold files, and I/O screens. [Table 4-12](#) gives a description for each of the related screens for the system configuration buttons.

Table 4-12 System Configuration Buttons

Button	Description
	<p>System Setup Shows the screens used for system configuration. Refer to Chapter 10 for information.</p>
	<p>Files Lets you set the process parameter files necessary to operate the hot runner system for a particular mold. Refer to Chapter 6 for information.</p>
	<p>I/O Lets you configure the system’s inputs and outputs. Refer to Section 14.1 for information.</p>

4.2 Screen Keyboards, Keypads, and Selection Menus

The Delta5 controller uses screen keyboards, keypads, and selection menus. Keyboards are used to enter text, such as names for users, zones, and groups. Keypads are used to enter numeric values for operation settings, such as temperatures, power, time, and percentages. Selection menus are used to easily select an item in a drop-down list. [Figure 4-2](#) shows a typical keyboard, keypad, and selection menu. Their functions are identified in the title bars.

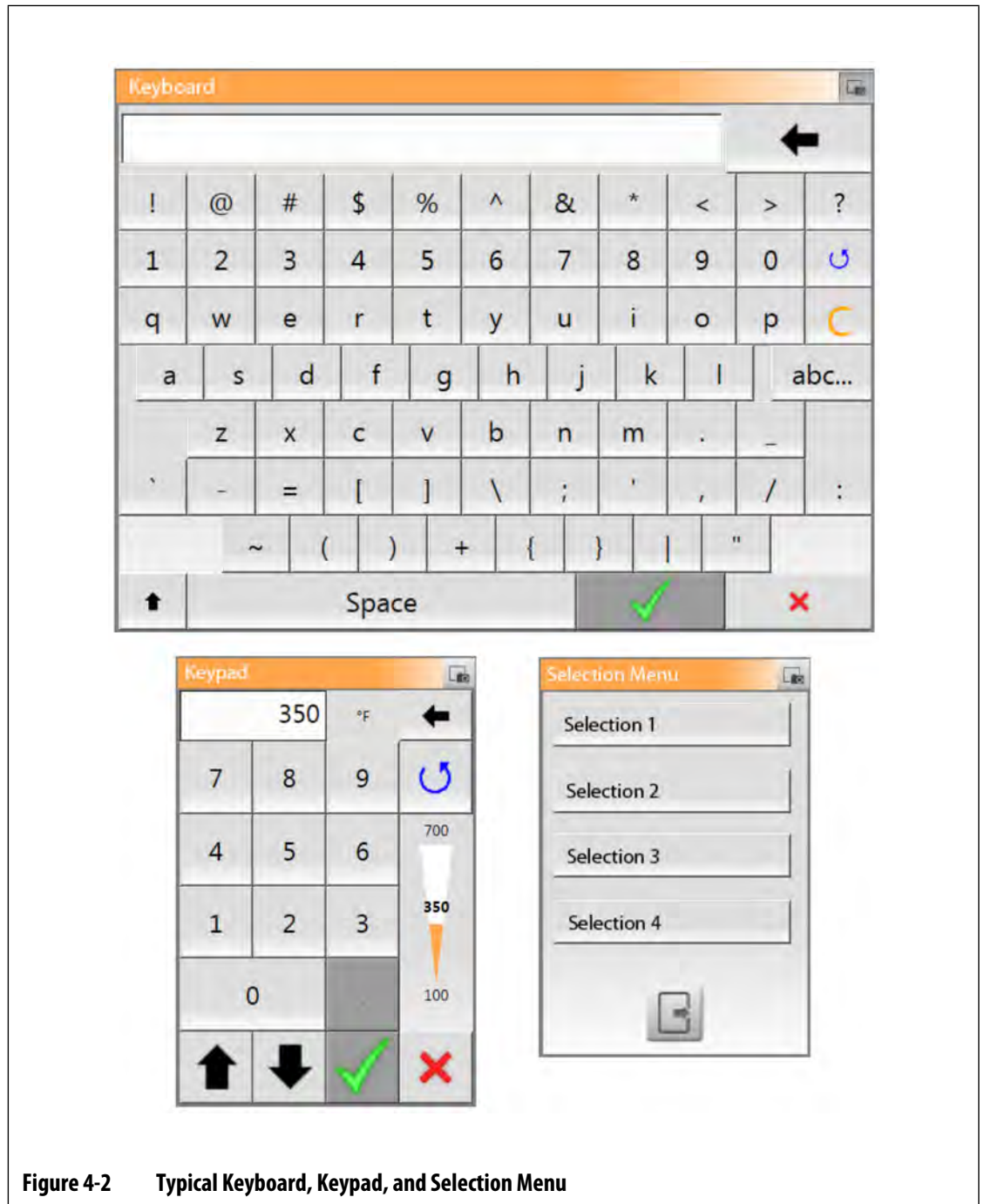
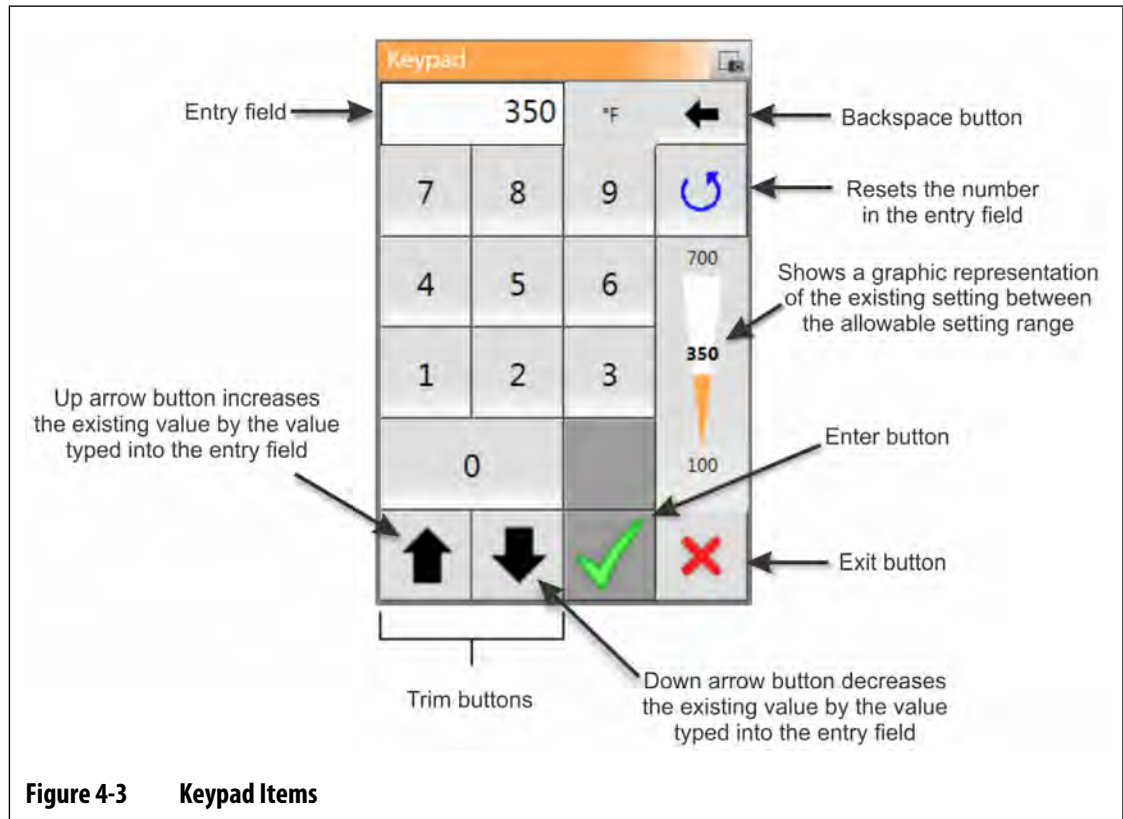


Figure 4-2 Typical Keyboard, Keypad, and Selection Menu

4.2.1 Keypad Use

The screen keyboards and selection menus are easy to use. You type in text or make a selection, and then select the green check mark button to accept the entry.

The screen keypads are also easy to use, but specific features must be identified. [Figure 4-3](#) gives descriptions of the keypad items.



4.2.1.1 Enter a Specified Setpoint Value

You can enter a specific value for a setpoint. To do this, type the numbered value on the screen keypad, and then select the green check mark button to accept the change.

4.2.1.2 Increase or Decrease a Setpoint by a Specified Value

You can raise or lower an existing setpoint by a specified amount with the use of the trim (arrow) buttons at the bottom of the screen keypad.

The up-arrow trim button increases the existing setpoint by the value typed in the entry field. For example, if the temperature setpoint is 350 °F, and you type 10° in the entry field, when the up trim button is selected, the temperature setpoint changes to 360 °F.

The down-arrow trim button decreases the existing setpoint by the value typed in the entry field. For example, if the temperature setpoint is 350 °F, and you type 10° in the entry field, when the down trim button is selected, the temperature setpoint changes to 340 °F.

4.3 Select a Language

The Altanium screens are available in fourteen languages. The default language is English. All screens have a Language Selection (globe) icon that shows the available languages.

To select a language, do the steps that follow:

1. Touch the **Language Selection** button at the bottom of the screen. Refer to [Figure 4-4](#).



Figure 4-4 Language Selection Button

A small Select Language dialog window shows. Refer to [Figure 4-5](#).

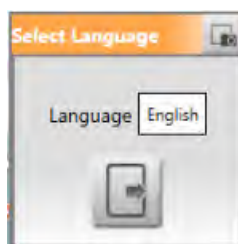


Figure 4-5 Select Language Window

2. Touch the Language field and a window shows with a list of languages. Refer to [Figure 4-6](#).



Figure 4-6 Language Selection Dialog Box

3. Select a language.
4. Touch the **Exit** button.

4.4 Print to a File

To open the Print dialog box, touch the **Print** button on any Altanium screen. Refer to [Figure 4-7](#).

Files are saved in System\Reports folders.



Figure 4-7 Print Button

To print a single file, do the steps that follow:

1. Touch the **Print** button.
2. Select a report type.
3. Select a file format.
4. Touch the **Accept** button to save the selected content to a System\Reports folder.
5. Copy the saved content to a USB drive or Network, as necessary.

Continuous Printing lets you set up print reports at specified intervals. You can select the type of report to be generated (Reports Type) and File Format. You can also specify the print interval and duration time. Files are generated after each interval timer completes. At the specified duration time, or when the user clicks the **Stop** button, Continuous Printing is stopped. The generated files have the same information as with single file printing.

To print to a file with the Continuous Printing feature, do the steps that follow:

1. Touch the **Print** button.
2. Touch the **Continuous Printing** button on the Print dialog window. Refer to [Figure 4-8](#).
The Continuous Printing options are shown on the Print dialog window.
3. Select a report type.
Refer to [Section 4.4.1](#) for a description of each print report type.
4. Select a file format.
5. Touch the **Print Interval** field and enter an interval time.
6. Touch the **Print Duration** field and enter a duration time.
7. Touch the **Start** button to start the Continuous Printing.
8. When the Continuous Printing has completed, copy the saved content to a USB drive or Network, as necessary.

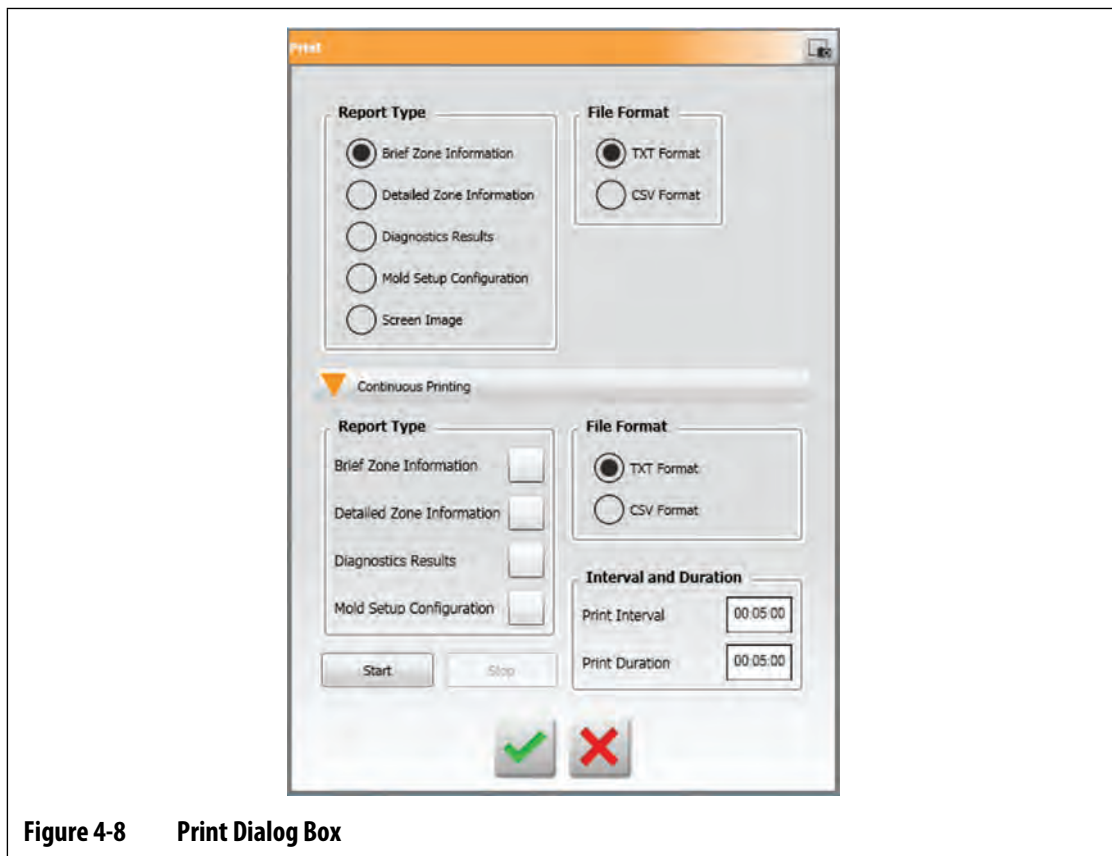


Figure 4-8 Print Dialog Box

4.4.1 Print Report Descriptions

This section provides a description of each print report.

Print files are automatically saved to one of the paths that follow:

- System\Reports\Zones
- System\Reports\Diagnostics
- System\Reports\Setups
- System\Reports\Screens

Refer to [Table 4-13](#) for a description of the print reports.

Table 4-13 Print Reports

Print Report Type	Description
Brief Zone Information	<p>From the Text View screen, the information that follows is printed to a file:</p> <ul style="list-style-type: none"> • Zone number • Setpoint and units • Actual temperature and units
Detailed Zone Information	<p>From the Text View screen, the information that follows is printed to a file:</p> <ul style="list-style-type: none"> • Zone Number • Zone Name • Setpoint • Temperature • Power • Amperage • Alarm Limit • Abort Limit • Regulation Mode • Watts • 240V Watts • Volts AC • Resistance
Diagnostics Results	<p>From the Test Results screen, the result information that follows is printed to a file:</p> <ul style="list-style-type: none"> • Zone Number • Zone Name • Sensor • Fuses • T/C • Amperage • Volts AC • Watts • Resistance • Wiring • Isolation • Earth Leakage • Bake Out • Time

Table 4-13 Print Reports (Continued)

Print Report Type	Description
Mold Setup Configuration	<p>The mold setup configuration information that follows is printed to a file:</p> <ul style="list-style-type: none"> • Zone Number • Zone Name • Setpoint • Minimum Setpoint Limit • Maximum Setpoint Limit • Power Limit • Alarm • Abort • AMC • PCM • Regulation • Manual Standby Setpoint • Remote Standby Setpoint • Manual Boost Setpoint • Remote Boost Setpoint • Sensor input • Assign Leader Zone • Output (Zero Cross or Phase Angle) • Earth Leakage Enable • Control (PID or ART) • P (Proportional) • I (Integral) • D (Derivative)
Screen Image	Saves the current user interface screen to file in an image file format (.png).

4.5 Online Help

The online help is a Portable Document Format (PDF) file of the Altanium Delta5 User Guide. To use the online Help, do the steps that follow:

1. Touch the **Help** button on an Altanium screen.



A Help dialog window shows a PDF file of the user guide.

2. Use the dialog window to navigate to the necessary information.
3. To close the PDF file, touch the **Exit** button.

Chapter 5 Security and Administration

This chapter describes user management and screen security, which are done from the System Setup screen. Use the User Management and Screen Security tabs at the bottom of the System Setup screen to set the user roles and configure the items described in this chapter. The other tabs at the bottom of the System Setup screen are described in [Chapter 10](#).

5.1 User Management and Security Screens

Roles are assigned to users to control access to specific features or operations on the Altanium screens. The user roles in a hierarchy as described in [Table 5-1](#).

Table 5-1 User Roles

Role	Definition
Operator	Edit screen data as defined by Administrator.
Supervisor	Edit screen data, including extended responsibility of certain screens as defined by Administrator.
Administrator	All the features of Supervisor plus the ability to create, delete, rename, and assign all roles.

The system administrator manages users and controls security settings for each user. Administrators can add a user, change a user password, and delete a user using the User Management screen.

5.1.1 Set User Roles

To set user roles, do the steps that follow:

1. Log in with Administrator privileges.
2. On the Home screen, touch the **System Setup** icon.
3. Touch the **User Management** tab at the bottom of the System Setup screen. Refer to [Figure 5-1](#).

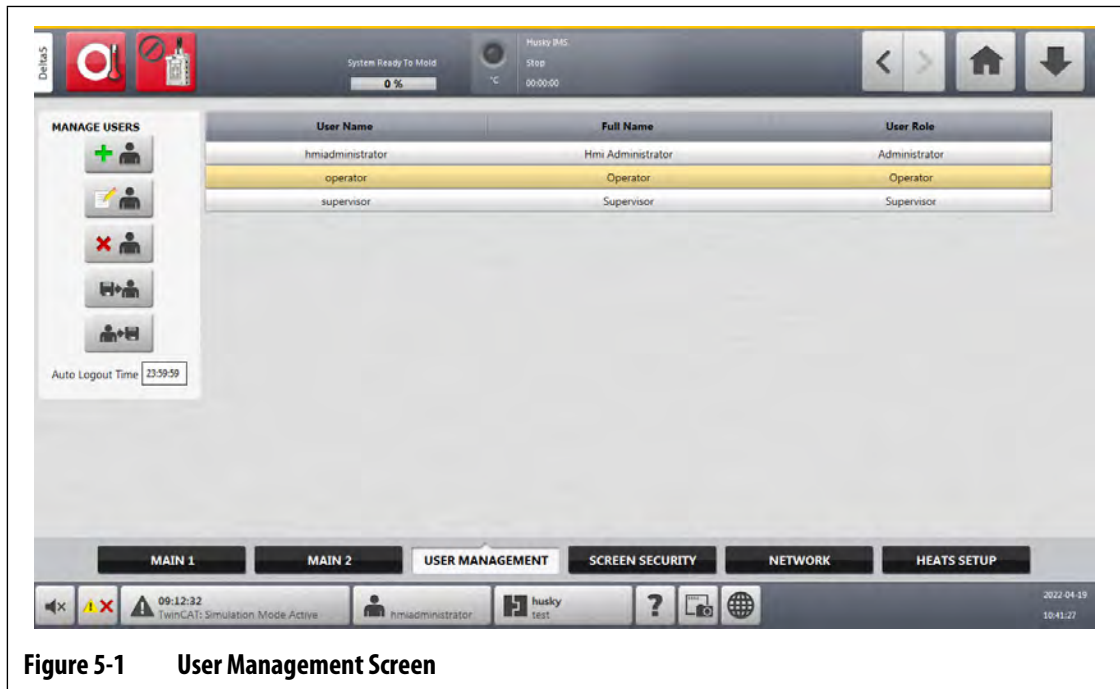


Figure 5-1 User Management Screen

4. Touch one of the buttons described in Table 5-2 to manage users.

Table 5-2 Manage Users Roles

Button	Description
	Add User Used to add a user to the system.
	Change User Settings Used to edit a name, password, or user role for a selected user.
	Delete User Used to remove a user from the system.
	Import User Profile Opens a dialog window to import a user profile. A USB drive must be used for this operation. A user profile is first saved (exported) from a controller onto the USB drive. The USB drive is then installed on a different controller and the user profile is imported from the drive onto the that controller.
	Export User Profile Opens a dialog to export a user profile. A USB drive must be used for this operation. A user profile is first saved (exported) from a controller onto the USB drive. The USB drive is then installed on a different controller and the user profile is imported from the drive onto the that controller.

5. Enter or change the user information in the dialog window that shows. [Figure 5-2](#) shows the dialog window to add a user.



Figure 5-2 Add User Dialog Window

5.1.2 Set Screen Security

Use Screen Security to assign what user roles have access to specified features and operations on the Altanium screens.

The sections that follow describe the screens on which user roles are assigned.

5.1.2.1 Screen Security - Main 1 Screen

Touch the **Screen Security** tab on the System Setup screen and then touch the **Main 1** tab to see the Main 1 screen user role items. Touch the field next to each item and then select the user role for that item in the dialog window that shows.

Figure 5-3 shows the Main 1 screen.



Figure 5-3 Screen Security - Main 1 Screen

Table 5-3 describes the user role items.

Table 5-3 Screen Security - Main 1 Screen

Item	Description
Enable User Security	Used to enable or disable user security as a whole.
Controller Units	Select the user role that can change the controller units of measurement and the Force Temperature Units parameter on the System Setup screen.
Process Limits Edit	Select the user role that can operate functions on the Process Limits screen; however, the Default user has permission to change the Grid Selection field.
Printing	Select the user role that can operate the print feature.
Network Setup	Select the user role that can operate network setup functions and the dashboard application parameters on the Network Setup screen.

Table 5-3 Screen Security - Main 1 Screen (Continued)

Item	Description
Remote Access	Select the user role that can operate the Remote Service Assistant utility on Network Setup screen.
Digital I/O Configuration	Select the user role that can configure the digital I/O on the Digital I/O screen.
Log Transfer	Select the user role that can download the event log or data log in the Log Transfer section of the System Setup screen.
Options and Licensing	Select the user role that can load a license file that enables the options a user has purchased.
Mold Setup Auxiliary Actions	Select the user role that can view files (mold setups, images, txt files and PDF documents) and operate the buttons that follow on the Files screen: Create Folder, Delete, Copy, Paste, and Rename.
Mold Setup Load Action	Select the user role that can load a mold setup configuration file and to create a new mold setup configuration file on the Files screen.
Mold Setup Save Action	Select the user role that can save changes to mold setup files and use the Save As function on the Files screen.
System Data	Selects the user role that can change the Company Name.
Date and Time	Select the user role that can set the date and time.
Troubleshooting Data	Selects the user role that can export diagnostic data for Husky service personnel to troubleshoot problems.
User Management	Select the user role that can use the User Management screen operations.
Data Collection Setup	Select the user role that can set the data collection variables and selection.
Turn Off Display	Select the user role that can set the time limit in which the touch screen must be used. When the time limit ends the Altanium display turns off for power conservation.
Basic Controller Operation	Select the user role that can operate the major controller function buttons: Stop, Start, Standby, and Boost. Stop is always available. This setting also grants permission to operate the UltraSync-E control mode buttons. For more information about buttons, refer to Section 4.1.3 .
Clear Inactive Alarms	Select the user role that can clear audible alarms on the Alarms screen.
Reset Alarms	Select the user role that can reset audible alarms on the Alarms screen.
Auto Log Out	Select the user role that can configure the auto logout parameter in the User Management screen
Interface Settings (Shotscope NX Interface)	Select the user role that can set the dashboard interface items on the Network tab of the System Setup.

Table 5-3 Screen Security - Main 1 Screen (Continued)

Item	Description
Interface Settings (OPC UA)	Select the user role that can set Open Platform Communication Unified Architecture (OPC UA) interface configurations.
Certificate Management (OPC UA)	Select the user role that can do the OPC UA X.509 certificate management.

5.1.2.2 Screen Security - Main 2 Screen

Touch the **Screen Security** tab on the System Setup screen and then touch the **Main 2** tab to see the Main 2 screen user role items. Touch the field next to each item and then select the user role for that item in the dialog window that shows.

Figure 5-3 shows the Main 1 screen.



Figure 5-4 Screen Security - Main 2 Screen

Table 5-3 describes the user role items.

Table 5-4 Screen Security - Main 2 Screen

Item	Description
Start/Stop Service (VNC)	Select the user role that can start and stop Virtual Network Computing (VNC).
Interface Settings (VNC)	Select the user role that can change the interface settings for VNC.
Save Process Data Setup	Select the user role that can save the process data setup.

5.1.2.3 Screen Security - Heats Page 1 Screen

Touch the **Screen Security** tab on the System Setup screen and then touch the **Heats Page 1** tab to see the Heats Page 1 screen user role items. Touch the field next to each item and then select the user role for that item in the dialog window that shows.

Figure 5-5 shows the Heats Page 1 screen.



Figure 5-5 Screen Security - Heats Page 1 Screen

Table 5-5 describes the user role items.

Table 5-5 Screen Security - Heats Page 1 Screen

Item	Description
Multi Group Operations	Select the user role that can operate the Multi Group screen functions.
Mold Picture View Edit	Select the user role that can use the edit function on the Mold Picture View screen.
ART Process	Select the user role that can operate the ART screen functions.
Mold Diagnostic Operations	Select the user role that can operate the Mold Diagnostics screen functions.
Energy	Select the user role that can manage the Altanium energy settings on the Energy Display screen.
Staging Configuration	Select the user role that can configure all the parameters in the Staging screen.
Global Output Power Limit	Select the user role that can configure the global output power limit parameter in the System Set up screen
Monitor Zone Settings	Select the user role that can configure the parameters in the Monitor Zone Settings panel of the System Setup screen.

Table 5-5 Screen Security - Heats Page 1 Screen (Continued)

Item	Description
Part Counting Setup	Select the user role that can use the Part Counting Setup function on the Heats Setup tab of the System Setup screen.
Temperature Calibration	Select the user role that can use the parameters in the Calibration screen to calibrate temperatures.
No Heater Detected Enable	Select the user role that can enable or disable no-heater detection feature in the Heats Setup of the System Setup screen.
Thermocouple Reading	Select the user role that can select and clear the Display Thermocouple Reading for Manual Zones checkbox on the System Setup screen.
Power Deviation	Select the user role that can select the Setup Alarm button in the Power Deviation section on the System Setup screen.
Zone Slot Configuration	Select the user role that can operate the Zone Slot Configuration fields on the System Setup screen and the fields on the Zone Slot Configuration screen.
Zone Alarm Control Settings	Select the user role that can configure all the parameters in the Zone Alarm Control panel of the System Setup screen.
Mold Cooling Enable Limit	Select the user role that can change this parameter in the Mold Cooling Enable panel of the System Setup screen.
Remote Load Setup	Select the user role that can configure all the parameters in the Remote Load Setup dialog window. This option must be purchased before the user can access this dialog window.
SPI	Select the user role that can configure parameters in the SPI panel of the System Setup screen. SPI must be installed on the system.
Resin Protection Timer	Select the user role that can set the protect resin timer on the Heats Setup screen in the System Setup.
Color Change	Select the user role that can set the parameters for the color change screen.
Soft Start Enable	Select the user role that can enable or disable Soft Start on the Heats Setup tab of the System Setup screen.
Soft Start Setup	Select the user role that can set the Soft Start Minimum Limit temperature on the Heats Setup tab of System Setup screen.
Earth Leakage Fault Enable	Select the user role that can enable and disable the System Earth Leakage Enable checkbox on the Heats Setup tab of the System Setup screen.
Earth Leakage Fault Setup	<p>Select the user role that can operate the fields that follow on the System Setup screen:</p> <ul style="list-style-type: none"> • Earth Leakage Fault Enable checkbox • Earth Leakage Limit field • Display Earth Leakage Reading checkbox • Circuit Overload Enable checkbox • Circuit Test Enable checkbox

Table 5-5 Screen Security - Heats Page 1 Screen (Continued)

Item	Description
Bake Out Enable	Select the user role that can enable or disable the bake out function on the Heats Setup tab of the System Setup screen.
Bake Out Setup	Select the user role that can configure the bake out fields on the Heats Setup tab of the System Setup screen.
Auto Following Enable	Select the user role that can enable the Auto Following function on the Heats Setup tab of the System Setup screen.
Autos Following Setup	Select the user role that can set up Auto Following Power Limit percentage on the Heats Setup tab of the System Setup screen.

5.1.2.4 Screen Security - Heats Page 2 Screen

Touch the **Screen Security** tab on the System Setup screen and then touch the **Heats Page 2** tab to see the Heats Page 2 screen user role items. Touch the field next to each item and then select the user role for that item in the dialog window that shows.

Figure 5-6 shows the Heats Page 2 screen.

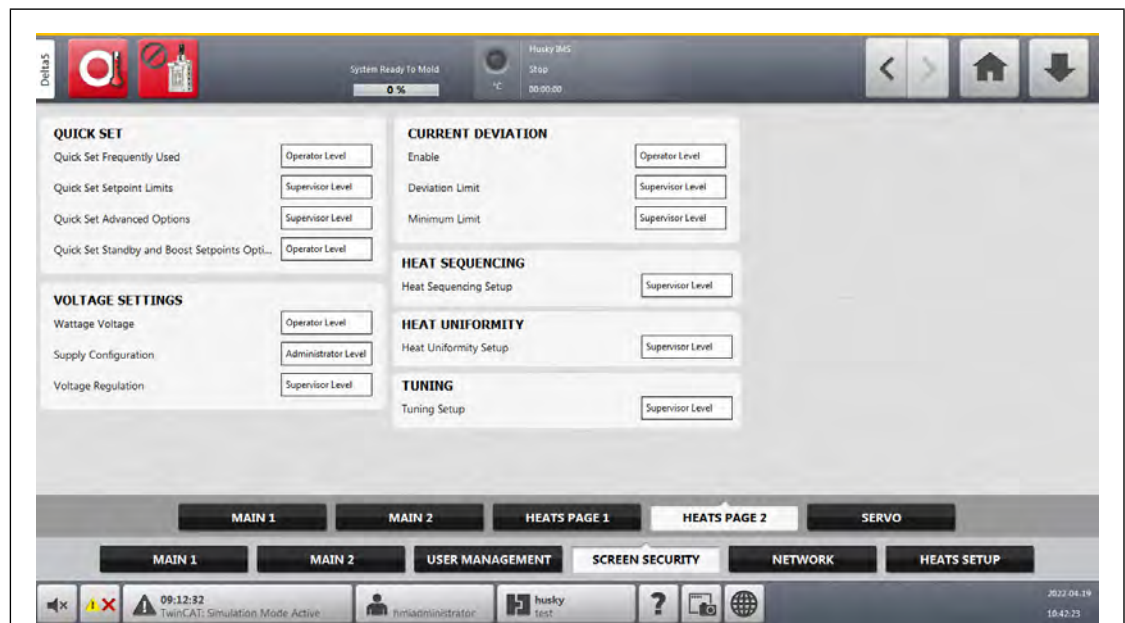


Figure 5-6 Screen Security - Heats Page 2 Screen

Table 5-6 describes the user role items.

Table 5-6 Screen Security - Heats Page 2 Screen

Item	Description
Quick Set Frequently Used	Select the user role that can change the fields in the Frequently Used drop-down list on the Quick Set screen.
Quick Set Setpoint Limits	Select the user role that can change the fields in the Setpoint Limits drop-down list on the Quick Set screen.

Table 5-6 Screen Security - Heats Page 2 Screen (Continued)

Item	Description
Quick Set Advanced Options	Select the user role that can change the fields in the Frequently Used, Zone Edit, Advanced Settings, and Control Settings drop-down lists on the Quick Set screen.
Quick Set Standby and Boost Setpoints Options	Select the user role that can change the fields in the Manual Standby, Manual Boost, Remote Standby, and Remote Boost drop-down lists on the Quick Set screen.
Wattage Voltage	Select the user role that can change the Wattage Voltage field on the Heats Setup tab of the System Setup screen.
Supply Configuration	Select the user role that can change the Supply Configuration field on the Heats Setup tab of the System Setup screen.
Enable	Select the user role that can enable or disable the Current Deviation on the Heats Setup tab of the System Setup screen.
Deviation Limit	Select the user role that can change the Current Deviation Limit percentage field on the Heats Setup tab of the System Setup screen.
Minimum Limit	Select the user role that can change the Current Deviation Minimum Limit amperage field on the Heats Setup tab of the System Setup screen.

5.1.2.5 Screen Security - Servo Screen

Touch the **Screen Security** button on the Home screen and then touch the **Servo** tab to see the Servo screen user role items. Touch the field next to each item and then select the user role for that item in the dialog window that shows.

Figure 5-7 shows the Servo screen.



Figure 5-7 Screen Security - Servo Screen

Table 5-7 describes the Servo screen user role items.

Table 5-7 Screen Security - Servo Screen

Item	Description
Operation - Basic	Select the user role that can change basic operation fields when servo equipment is installed on the Altanium controller.
Operation - Advanced	Select the user role that can change advanced operation fields when servo equipment is installed on the Altanium controller.
Configuration - Basic	Select the user role that can change basic configuration fields when servo equipment is installed on the Altanium controller.
Configuration - Advanced	Select the user role that can change advanced configuration fields when servo equipment is installed on the Altanium controller.
Operating Limits - Basic	Select the user role that can change the basic operation limit fields when servo equipment is installed on the Altanium controller.
Operating Limits - Advanced	Select the user role that can change the advanced operation limit fields when servo equipment is installed on the Altanium controller.
I/O Signal Interface	Select the user role that can change the input and output interface fields when servo equipment is installed on the Altanium controller.
Motion Profile	Select the user role that can change the motion profile fields when servo equipment is installed on the Altanium controller.
Permissions	Select the user role that can assign permissions for servo operation fields when servo equipment is installed on the Altanium controller.
Equipment Protection	Select the user role that can change the Equipment Protection options on the System Setup (Main tab): Air Filter and Servo Cabinet Internal Temperature

5.1.3 User Preferences

If a user is logged onto the system and makes changes to the unit of measurement or language selection, these values will be saved to that user's profile after logout and will be recalled the next time the same user logs in again.

5.1.4 Auto Logout

A system-wide timer will log the user off if there is no touch screen activity within a specified timeout period. The default setting is five minutes. The minimum value is 10 seconds.

To change the auto logout timeout period, do the steps that follow:

1. Log in with Administrator privileges.
2. On the Home screen, touch the **System Setup** button and then the **User Management** tab.

3. Touch the **Auto Logout Time** field and enter the desired time value in the dialog window. Refer to [Figure 5-8](#).
4. Touch the **Accept** (check mark) button.

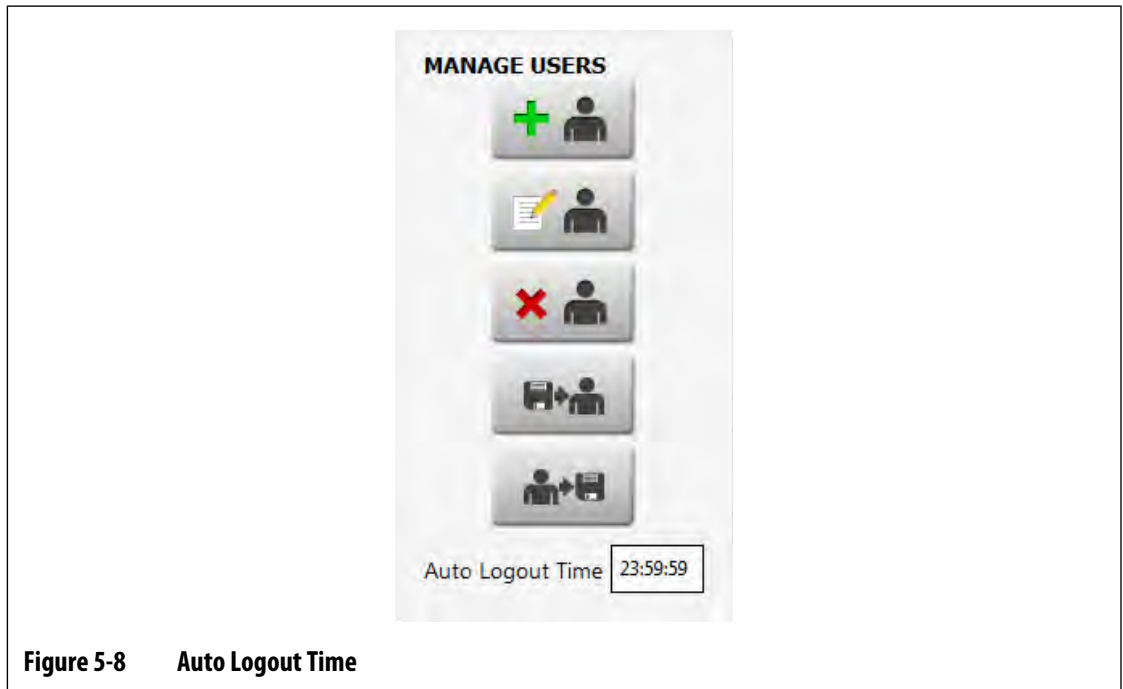


Figure 5-8 Auto Logout Time

Chapter 6 Mold Setups

A mold setup contains the process parameters required by Altanium to operate the hot runner system for that particular mold. On the Home screen, touch the **Files** button to open the Files screen for mold setup. This screen can also be accessed from any screen by touching the Files button in the system footer.

6.1 Files Screen

The Files screen is used to store and manage files, such as mold setups, images, documents, and reports. Refer to [Figure 6-1](#).

Files are organized in a tree structure and are stored in mold, system, and user folders. Each mold folder lets you store mold setups, images, and documents associated with each mold. The screen is divided into two panes. The left side contains all directories that are on the Altanium system's local hard drive, and the right side displays all available directories and files from an external source, such as a USB disk or a network file share.

The Files screen items are described in [Table 6-1](#). The screen buttons are described in [Table 6-2](#).

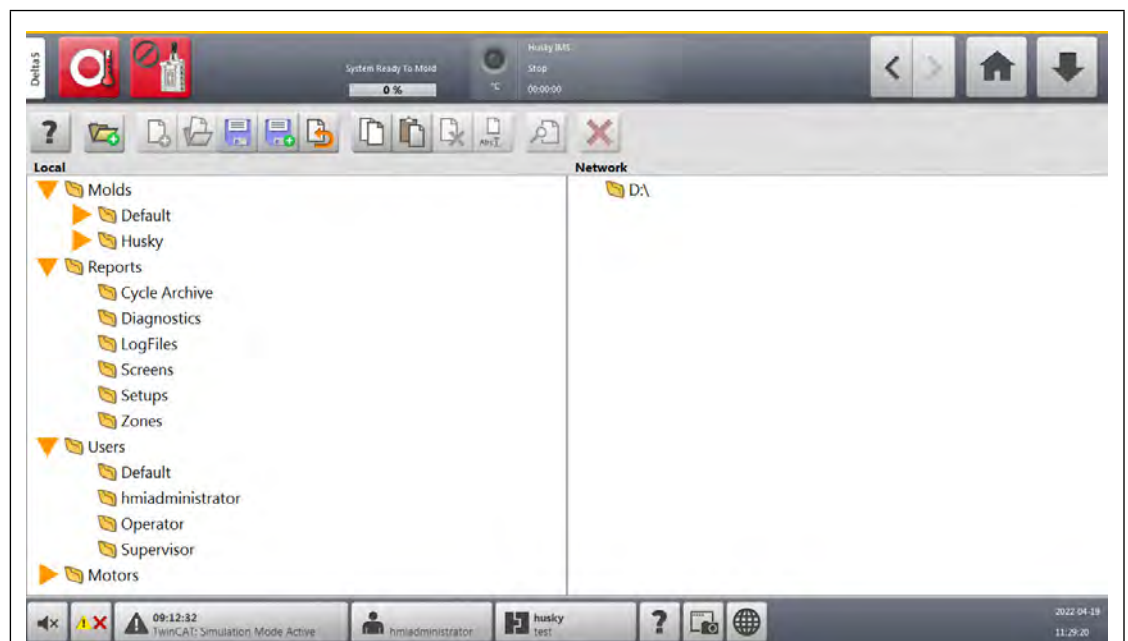


Figure 6-1 Files Screen

Table 6-1 Files Screen Item Descriptions

Item	Description
File Tree	<p>The local drive holds all stored data contained in the Files screen. To help better organize and store files, there are three root directories included by default. They are the Molds folder, Reports folder, and Users folder.</p> <p>USB storage devices and network folders are shown by default in the right pane when connected to the system.</p>
Molds Folder	<p>The Molds folder is used to manage files related each mold and stored in a user-defined subfolder. Touch the Molds folder to see its sub folders. Touch each sub folder to see the mold setup files, images, and PDF documents contained in the sub folder. The default folder is located in this directory and contains the master mold file that contains the factory default settings.</p>
Reports Folder	<p>Touch the Reports folder to see all reports and documents contained in the selected system folder.</p>
Users Folder	<p>Touch the Users folder to see the files related to each operator.</p>

Table 6-2 Files Screen Button Descriptions














Button	Description
	<p>Help</p> <p>Gives descriptions of the mold setup icons.</p>
	<p>New Folder</p> <p>Used to make a new tool (mold) subfolder in the Molds main folder.</p>
	<p>New Mold Setup</p> <p>Used to make a new mold setup file. All new mold setup files are made based on the settings contained in the Default mold setup file. This button is not enabled unless a Molds folder is selected.</p>
	<p>Load Mold Setup</p> <p>Used to load a mold setup file. This button is not enabled unless a mold setup file is selected. The Default setup file cannot be loaded directly.</p>
	<p>Save Changes</p> <p>Used to permanently save all changes to the loaded mold setup file. This operation only has an effect on the loaded mold setup file, regardless of what is selected on the screen.</p>
	<p>Save As</p> <p>Used to save the currently loaded mold setup file with a new name. This operation only has an effect on the loaded mold setup file, regardless of what is selected on the screen.</p>

Table 6-2 Files Screen Button Descriptions (Continued)

Button	Description
	<p>Discard Changes</p> <p>Used to set the loaded mold setup file back to the state after it was last saved (with the Save Mold Setup button). All unsaved changes are discarded. This operation only has an effect on the loaded mold setup file, regardless of what is selected on the screen.</p>
	<p>Copy</p> <p>Used to copy mold setups, images, or documents from one folder or device.</p>
	<p>Paste</p> <p>Used to paste mold setups, images, documents, or notes that were copied from one folder or device into a different folder.</p>
	<p>Delete</p> <p>Used to delete a mold folder, mold setup, image, or document. A message is shown to make sure you want to complete the operation. This button is not available unless a folder or file is selected.</p>
	<p>Rename</p> <p>Used to open the screen keyboard to rename a mold folder, mold setup, image, note, or document. This button is not enabled unless a file or folder is selected.</p>
	<p>Preview</p> <p>Used to see a View window of the mold setup files, images, notes, and documents.</p>
	<p>Cancel</p> <p>Used to cancel the file copy.</p>

6.1.1 Make a New Mold Setup Folder

Use a mold setup folder to store multiple mold setup files.

To create a new Mold Setup folder, do the following:

1. Touch the **New Folder** button.
2. Enter the name of the new mold folder.
3. Touch the **Accept** button.

The new mold setup folder now shows below the Molds directory.

6.1.2 Make a New Mold Setup File

When a mold setup folder has been created, a new mold setup file can be added to it.

When a new mold setup file is created, and the Default folder contains only the Default mold setup file, the factory default setup file is copied and used as a template to build the new mold setup file.

If the Default folder contains a user-supplied setup file named "New Setup", the new setup file that is made would be a copy of the "New Setup" file. To make a "New Setup" file, copy a setup file, rename the file to "New Setup", and then copy the new file to the Default folder. This gives the user a specified template for all new setup files as an alternative to the factory default.

To create a new mold setup file, do the steps that follow:

1. On the Files screen, touch the desired mold folder.
2. Touch the **New Mold Setup** button. A dialog box will open.
3. Enter the name of the new mold setup.
4. Touch the **Accept** button.

6.1.3 Save Changes to a Mold Setup File

After a mold setup file has been loaded, all changes made to the file can be permanently saved.

To permanently save changes to a mold setup file, do the steps that follow:

1. On the Files screen, touch the **Save Changes** button. The Mold Setup - Save dialog window shows, so you can make sure the mold and file name in which the changes are to be saved are correct.
2. Touch the **Accept** button.

All changes are permanently saved to the loaded mold setup file.

6.1.4 Discard Changes to a Mold Setup File

All changes to a mold setup file are held in the system's data base until they are permanently saved or discarded. When changes are discarded, the mold setup file goes back to the state it was in after the last save was done.

To discard changes to a Mold Setup file, do the steps that follow:

1. On the Files screen, touch the **Discard Changes** button. The Mold Setup - Discard dialog window shows so you can make sure that the mold and file name that the changes are to be discarded are correct.
2. Touch the **Accept** button.

All changes are permanently discarded from the loaded mold setup file.

6.1.5 Save the Current Mold Setup File as a New File

When a Mold Setup file has been loaded, it can be saved as a new file.

To save the loaded Mold Setup file as a new file, do the steps that follow:

1. On the Files screen, touch the **Save As** button. The Mold Setup - Save As dialog box shows, so you can make sure that the mold and new name of the file are correct.
2. Touch the **Accept** button.

6.1.6 Load an Existing Mold Setup File

After a Mold Setup file is made, it is automatically loaded as the Mold Setup in the system.

To load a different Mold Setup, do the steps that follow:

1. On the Files screen, select the Mold Setup folder that contains the Mold Setup file to be loaded.
2. Touch the name of the mold setup file to be loaded.
3. Touch the **Load Mold Setup** button to load the selected mold setup.

After a mold setup is loaded, its name will be shown at all times on the Mold Setup Info button in the System Footer.

6.1.7 Delete Files

When it is not necessary to keep a file or folder on the internal disk, it can be deleted.

To delete a file or folder, do the steps that follow:

1. On the Files screen, touch the file or folder to be deleted.
2. Touch the **Delete** button.
3. A message shows that asks you to confirm the deletion. To continue, touch the **Accept** button. To cancel the deletion, touch the **Cancel** button.

6.1.8 Copy Files

Mold setups, images, documents, or notes can be copied from one folder or device to a different folder. Only files from folders with the same name or type can be copied into that folder. For example, a mold setup file can be pasted only into a mold setup folder.

To copy and paste a file, do the steps that follow:

1. On the Files screen, touch the file to be copied.
2. Touch the **Copy** button.
A Files - Copy dialog window shows.
3. Touch the **Accept** button.

4. Navigate to the destination folder, and then touch the **Paste** button to paste a copy of the file.
A Files - Paste dialog window shows.
5. Touch the **Accept** button.

6.1.9 Rename Files

To rename a file or folder, do the steps that follow:

1. On the Files screen, touch the file or folder to be renamed.
2. Touch the **Rename** button and type the new name in the field.
3. Touch the **Accept** button to save the name of the file.

6.1.10 Transfer Data to the Network

Use the Files screen to transfer Altanium data to the network. When the Altanium is connected to the network, the network folder structure appears by default on the Files screen. The network folders do not show when a USB device is connected.

6.1.11 Transfer Data with a USB Storage Device

Altanium data can be transferred with the use of USB disks or USB CD-ROM drives. When one of these devices is connected to the USB port, the folder structure of the USB storage device shows on the right side of the Files screen. The folder structure will not show when the device is disconnected. To transfer the files, copy and paste files from the USB disk to the local drive.

Chapter 7 Making Adjustments

Adjustments can be made to the process settings for a mold setup before starting the mold, or while the mold is running. This chapter describes how to use the Altanium system to monitor and modify the system.

The Altanium permits zone data to be shown in different graphical and textual formats. These include tabular views, images with text assigned to them, and views that are divided into groups of zones.

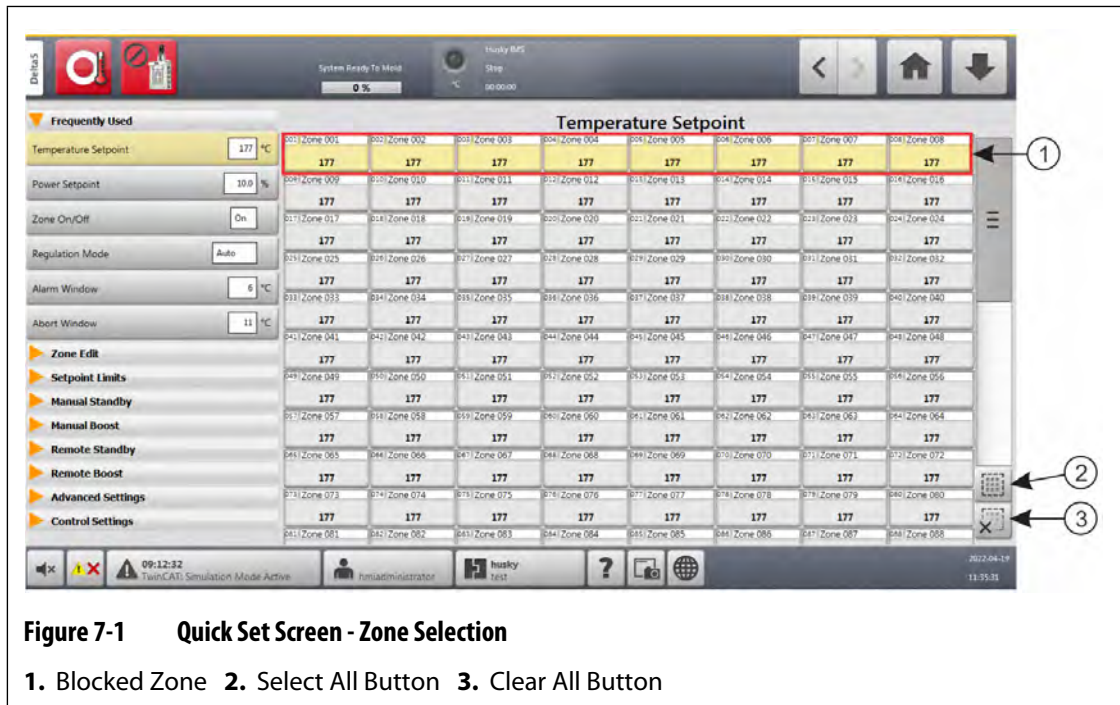
7.1 Zone Selection

Multiple zones can be selected from the screens that follow:

- ART Process
- Diagnostics Results
- Graphical View
- Mold Diagnostics
- Multi Group View
- Neo View
- Process Monitoring
- Quick Set
- Staging
- Text View
- Zone Calibration
- Zone Slot

There are three methods to select zones on a screen (refer to [Figure 7-1](#)):

- Touch one zone element. The individual zone becomes selected (highlighted).
- Touch the **Select All** button to select all the available zone elements.
- Use the Block function. Touch and hold a zone element for up to a second. This highlights the zone yellow and/or puts a gray border around it. Touch another zone element on the screen and the block of zones between the first and second selections are automatically selected.



7.2 Make a Zone Group

Use the Quick Set screen to select two or more zones to form a group. Refer to [Figure 7-2](#).

To make a group of zones, do the steps that follow:

1. On the Quick Set screen, touch and hold the first zone for one second to select it.
2. Touch the last zone you want to be in the group to select it.

All zones in between the first and last zones that you selected will also be selected and highlighted in yellow.

3. Touch the **Zone Edit** button.
4. Touch the **Group Name** field and type a group name.

A shortcut button to the new group will show at the bottom of the Quick Set screen. Touch a group shortcut button and the zones in that group will be highlighted.



Figure 7-2 Quick Set Screen - Make Zone Groups
 1. Zone Edit 2. Group Name 3. Group Shortcut Buttons

7.3 Multi Group View Screen

Use the Multi Group View screen to see all user-configured zone groups. Refer to [Figure 7-3](#). Each group has its own controls to synchronously energize or de-energize all zones in the group and put them into standby or boost mode.

NOTE: For information about how to make zone groups, refer to [Section 7.2](#).



IMPORTANT!

The **Stop**, **Start**, **Standby**, and **Boost** buttons at the top left corner of the screen operate all zones and override the group settings.

Touch the column heading to sort the information in that column. A red line at the top of the column header tells you that the information is in ascending order. A red line at the bottom of the column header tells you that the information is in descending order.

Touch the +/- button at the top right corner of the screen to toggle the Multi Group View screen between a two-column view and a one-column view.

Select one zone or a block of zones to automatically open the Quick Set screen with that zone or block of zones selected.

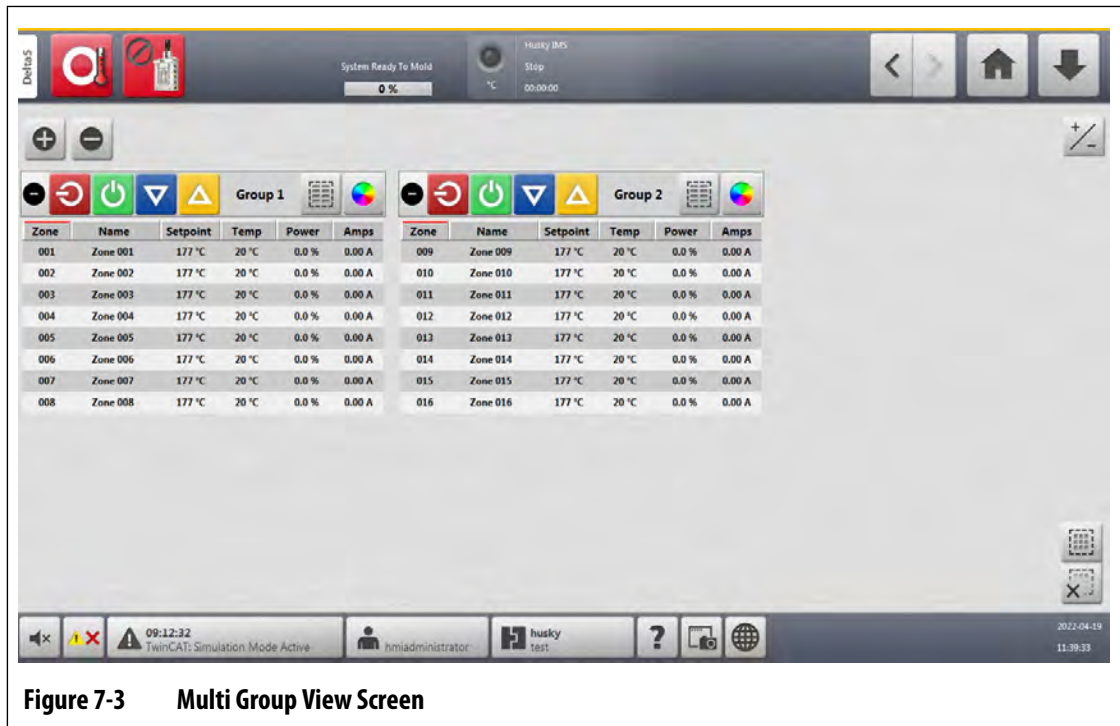








Figure 7-3 Multi Group View Screen

The buttons on the Multi Group View screen are described in Table 7-1.

Table 7-1 Multi Group View Screen Buttons

Button	Description
	Expand All Group Information Lists Used to expand all group information lists.
	Minimize All Group Information Lists Used to minimize all group information lists.
	Expand Related Group Information Lists Used to expand the related group information list. If this button is green, the actual temperature for all zones is within the lower alarm limit. If this button is black, the actual temperature for all zones is not within the lower alarm limit.
	Minimize Related Group Information Lists Used to minimize the related group information list. If this button is green, the actual temperature for all zones is within the lower alarm limit. If this button is black, the actual temperature for all zones is not within the lower alarm limit.

Table 7-1 Multi Group View Screen Buttons (Continued)

Button	Description
	<p>De-energize</p> <p>De-energizes the zones in that group if they are energized.</p>
	<p>Energize</p> <p>Energizes the zones in that group if they are not energized.</p>
	<p>Manual Standby</p> <p>Sets the zones in this group to Manual Standby. More than one group can be put in standby at the same time. This button will not operate if one or more groups are in boost mode.</p>
	<p>Manual Boost</p> <p>Sets the zones in this group to Manual Boost. More than one group can be put in boost mode at the same time. This button will not operate if one or more groups are in standby mode.</p>
	<p>Quick Set</p> <p>Opens the Quick Set screen with all of the zones automatically selected.</p>
	<p>Color Change</p> <p>Used to change the header colors. Refer to Section 7.3.1.</p>

7.3.1 Changing the Header Color

Users can select a header color for a group that is shown on the Multi Group View screen. For more information about how to make a group, refer to [Section 7.2](#).

To change the header color, do the steps that follow:

1. On the Multi Group View screen, touch the **Color Change** button above the group.
The Color dialog window shows. Refer to [Figure 7-4](#).
2. Touch a color square on the Color dialog window.

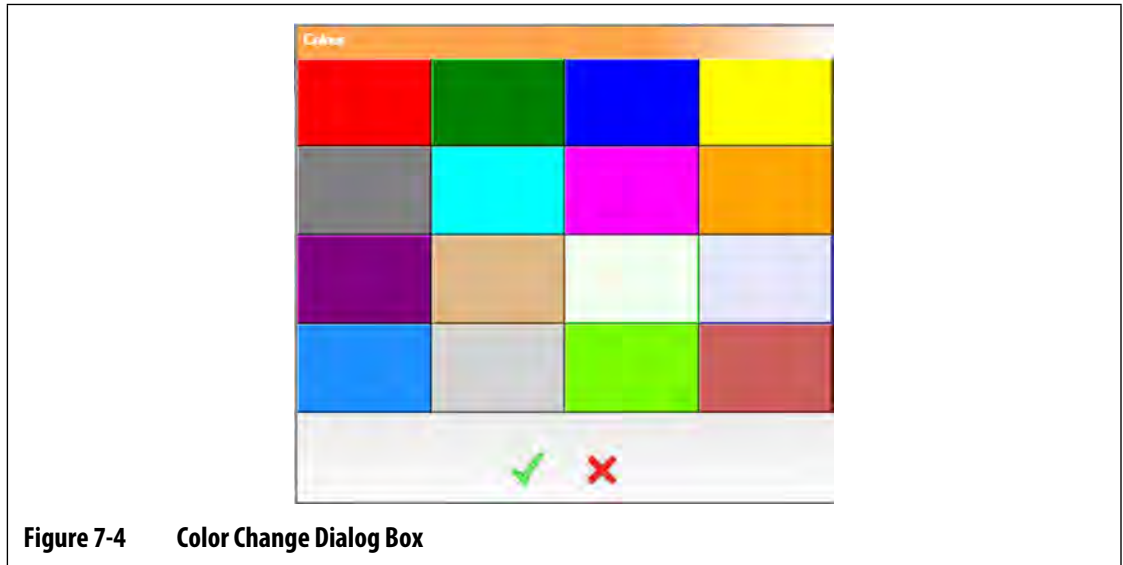


Figure 7-4 Color Change Dialog Box

3. Touch the **Accept** button.

7.4 Graphical View Screen

The Graphical View screen shows zones in a graphical format. This screen makes it easy to see the full status of the mold and not have to sort through detailed data. Figure 7-5 shows the Graphical View screen in full-screen mode.

Touch the **Graphical View** button on the Home screen.

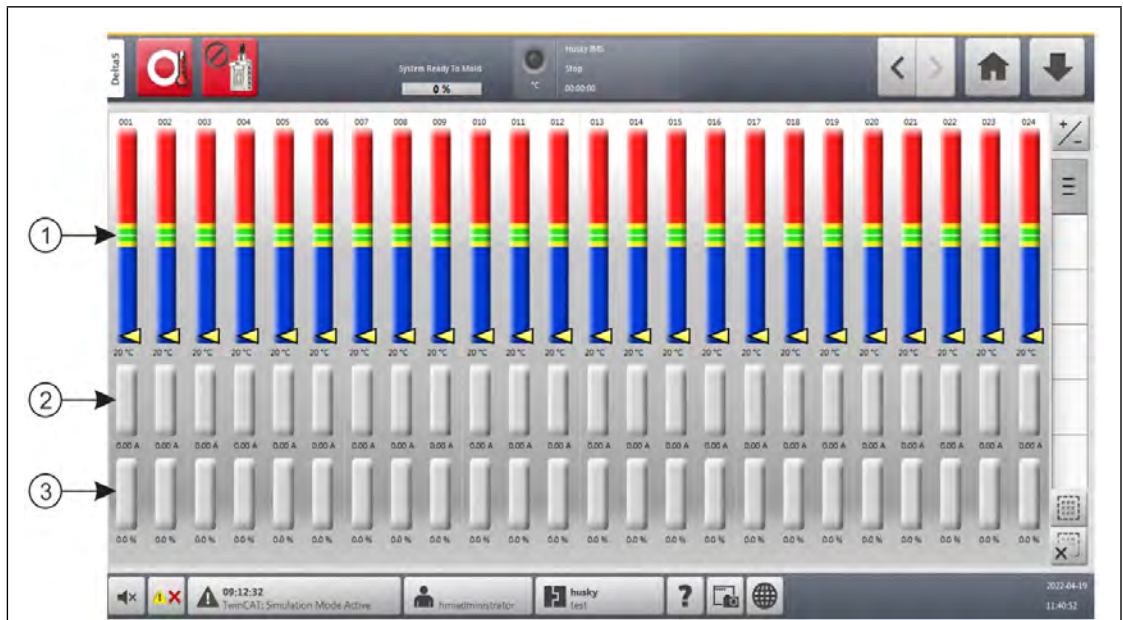


Figure 7-5 Graphical View Screen (Full-Screen Mode)

1. Zone Bars
2. Amperage Bars
3. Power Bars

Table 7-2 gives the descriptions for the bars shown on the Graphical View screen.

Table 7-2 Bar Descriptions

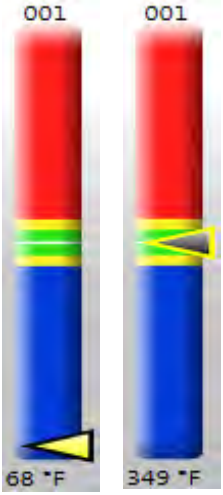




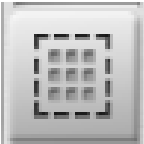

Item	Description
	<p>Temperature Bars</p> <p>Each bar on the screen graphically shows the temperature control for one zone. Each bar is labeled above with the zone number. The text shown at the bottom of each bar is the actual temperature for that zone.</p> <p>The different colors in each bar have a different meaning.</p> <ul style="list-style-type: none"> • The green area is the molding window. • The white hairline is the setpoint. • The yellow areas in the zone bar are the alarm ranges. • The red and blue areas in the zone bar are the abort ranges. • A blank gray bar shows that the zone is OFF. • The arrow is the actual temperature. <ul style="list-style-type: none"> - If the arrow is yellow, the temperature is not within the graph range. - If the arrow is black and splits the line, the temperature is at the setpoint.
	<p>Amperage Bars</p> <p>The amperage bars are below the zone bars. These show the amperage that is drawn by each heater. The text shown at the bottom of each bar is the actual current for that zone.</p>
	<p>Power Bars</p> <p>The power bars are located below the amperage bars. These show the percentage of power that is supplied to the heater. The text at the bottom of each bar is the actual power output percentage that is supplied to that zone.</p> <ul style="list-style-type: none"> • If a zone is in Auto (closed loop) regulation, the bar will fill with orange to show the percentage of power output. • If a zone is in Manual (open loop) regulation, the bar will fill with green to show the percentage of power output. • If a zone is set to Monitor mode, the bar will remain grey (there is no power output for zones set to Monitor mode).

Table 7-3 gives the descriptions for the buttons on the screen.

Table 7-3 Graphical View Screen Button Descriptions

Button	Description
	<p>Plus/Minus (Split/Full and Detailed Screens)</p> <p>Toggles the zone view between split- or full-screen mode. In split-screen mode (Figure 7-5), zone graphs are shown in two groups, one on the top and one on the bottom. In full-screen mode (Figure 7-6), the zone graphs fill the whole screen area. This also toggles the Neo View screen to show more zone details.</p>
	<p>Scroll Bar</p> <p>Use the scroll bar at the right of the screen to scroll between the top and bottom of a long screen page. If all of the available data fits in a single page, then the scroll bar will not be shown.</p>
	<p>Select All</p> <p>Touch this button to select all zones in the system. This will navigate to the Quick Set screen.</p>
	<p>Clear All</p> <p>Touch this button to deselect all zones.</p>

The Graphical View screen shows a maximum of 24 zones of information in full-screen mode (Figure 7-5) and 48 zones in split-screen mode (Figure 7-6). Touch and drag the scroll bar to bring additional zones into view. The system always shows up to 24 or 48 zones at one time by the screen mode you select.

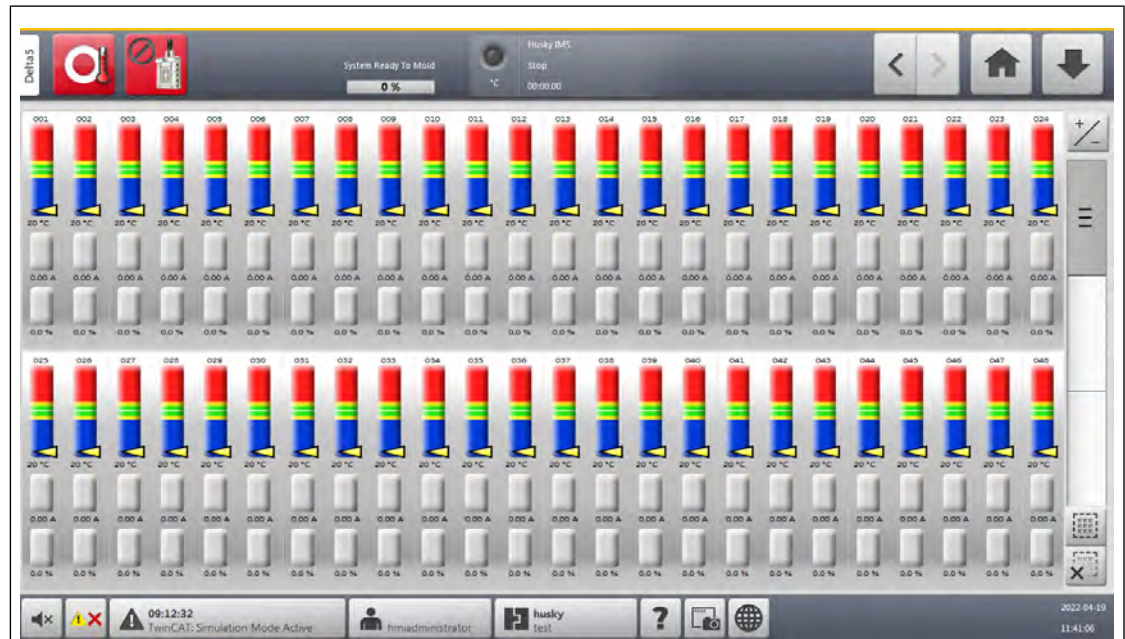


Figure 7-6 Graphical View Screen (Split-Screen Mode)

7.5 Neo View Screen

The Neo View displays zones in a block format. Each zone block contains text and numeric information about the zone. You can choose one of two views on this screen: simple or detailed.

To see the Neo View screen, touch the **Neo View** button on the Home screen.

7.5.1 Simple Screen mode

Figure 7-7 shows the Neo View screen in simple screen mode. The zone number and name are shown at the top of each zone block. The zone temperature is shown in the middle of the block. This makes it easy if you only want to watch the temperature of the zones.

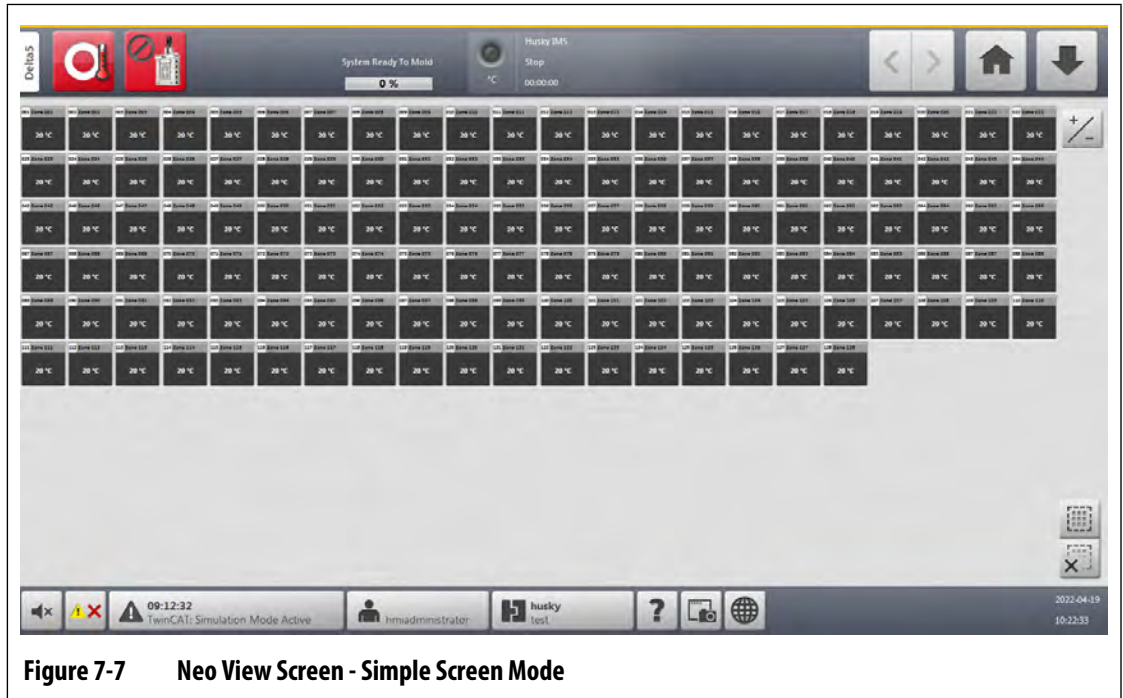


Figure 7-7 Neo View Screen - Simple Screen Mode

7.5.2 Detailed Screen mode

If you would like to see more detailed data for the zones, touch the Plus/Minus button at the top right corner of the screen.



Figure 7-8 shows the Neo View screen in detailed screen mode.



Figure 7-8 Neo View Screen - Detailed Screen Mode

In each zone block of the Neo View detailed screen, nine items of information are shown for the zone (refer to Figure 7-9).

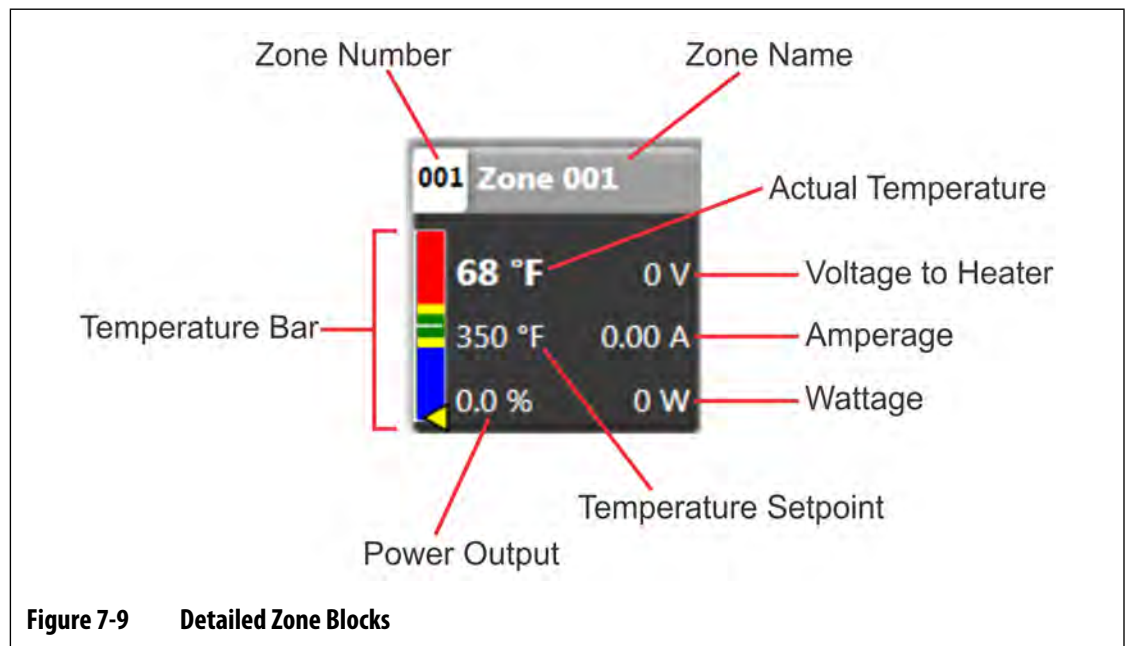


Figure 7-9 Detailed Zone Blocks

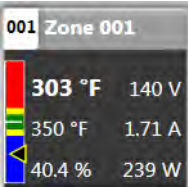
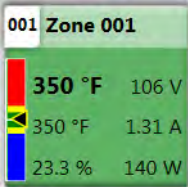

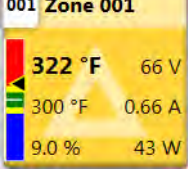
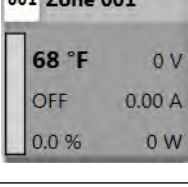
When a zone is energized, the numbered information fields will become active. The values will show what is being used to increase the zone temperature and to maintain the temperature at the zone’s setpoint. The temperature bar shows a graphical representation of the zone’s temperature (see the description of the Temperature Bars in Table 7-2).

7.5.3 Zone Block Background Color

The background color of a zone block will change to show the zone is at or near the temperature setpoint, or when the zone’s mode has changed (refer to [Table 7-4](#)).

NOTE: The zone blocks in [Table 7-4](#) show blocks from the Neo View screen in detailed mode. The colors are the same for the zone blocks in simple mode.

Table 7-4 Zone Block Colors

Zone Block	Color
	<p>Black</p> <p>A black background shows the zone is not energized or the zone temperature is increasing, but not yet near, or at the temperature setpoint.</p>
	<p>Green</p> <p>A green background shows the zone is "At Temperature". This means the zone is at, or near the temperature setpoint for the zone.</p>
	<p>Blue</p> <p>A blue background shows the zone has been changed to Standby mode.</p>
	<p>Yellow</p> <p>A yellow background shows the zone has been changed to Boost mode.</p>
	<p>Gray</p> <p>A gray background shows the zone has been disabled.</p>

7.5.4 Follower Zone Block

When a zone is assigned to be a follower to a different zone (leader), the follower zone block will show the leader’s zone number and name. Every second, the follower zone block’s number and name flash blue text to show the leader’s zone number and name.

Figure 7-10 shows an example of a follower zone. In the example, zone 4 has been assigned zone 5 as its leader. The number and name for zone 4 flashes blue text to show the leader zone.

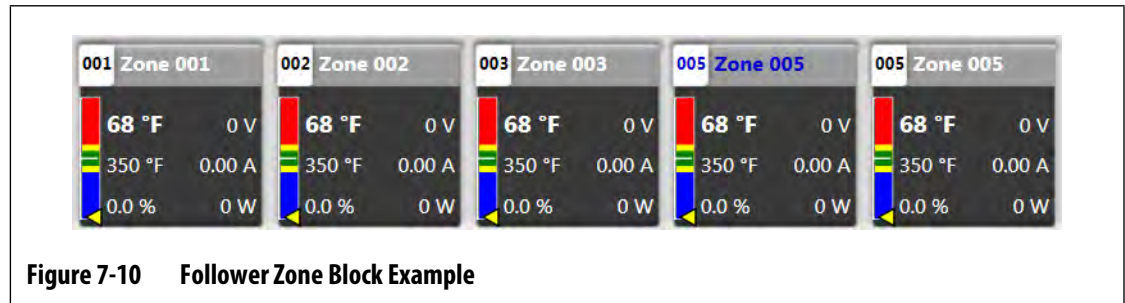


Figure 7-10 Follower Zone Block Example

7.5.5 Status Abbreviations

Some abbreviated text may show in the zone blocks that give additional status of the zones. Table 7-5 gives the descriptions of the abbreviated text.

Table 7-5 Status Abbreviations

Item	Description
ART	This is seen when the system automatically starts the ART process. When the ART process is completed, the block automatically changes back to the normal block.
B-O	This is seen when a zone is in bake out mode. It shows in the Power Output field of the zone block.
OL -OL	This is seen if the temperature value has exceeded 1112 °F or 600 °C. This is seen if the temperature value has exceeded 1112 °F or 600 °C. NOTE: These special values are only shown when ICC3.2 cards are installed in the system.
TC-n	If you change the Thermocouple Assignment value on a zone on the Quick Set screen, then the zone block name will toggle between itself and the sensor to which it is rewired.
----	If the Display Thermocouple Readings for Manual Zones setting in the System Setup screen is not selected, the actual temperature values will not be displayed on zones configured for manual regulation.

7.6 Text View Screen

The Text View screen shows zone information in a textual format. Refer to [Figure 7-12](#).

The screen is used to access detailed data for each zone and gives the most complete view of the process. To access the screen, touch the **Text View** button on the Home screen.

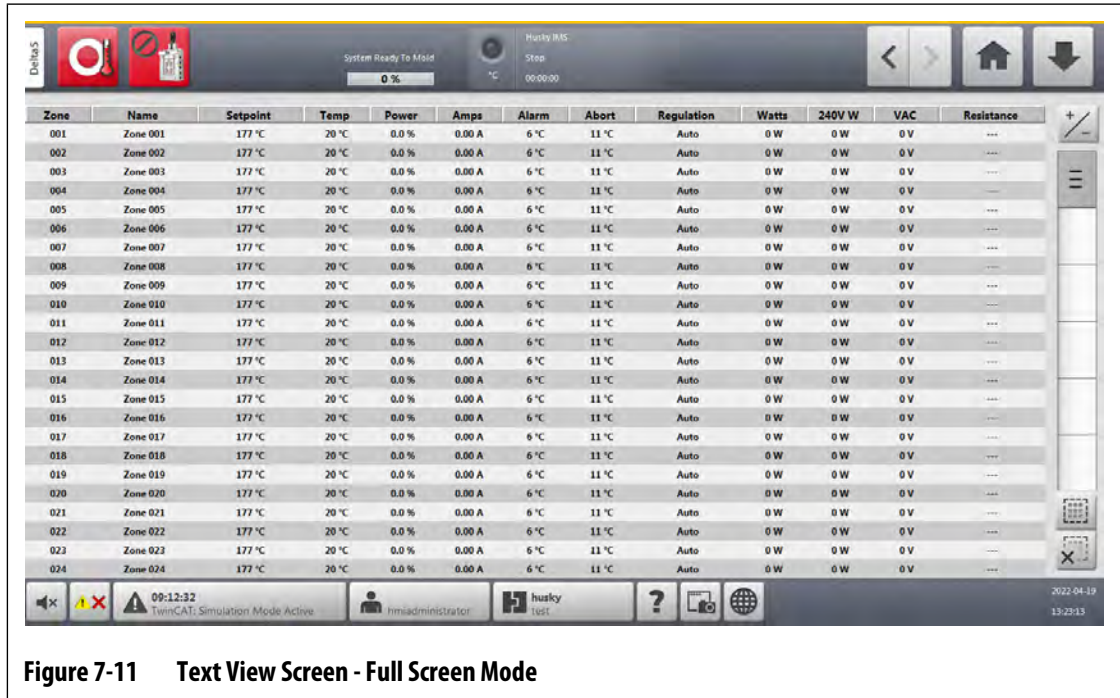


Figure 7-11 Text View Screen - Full Screen Mode

Table 7-6 gives descriptions of the items and buttons on the Text View screen.

Table 7-6 Text View Screen Item and Button Descriptions

Item/Button	Description
Zone Row	Each row in the Text view is a heat zone in the system. Touch a zone row and the Quick Adjustment panel (if enabled) will show on the right side of the screen. Refer to Section 7.7 . If the Quick Adjustment panel is not enabled, the Quick Set screen will show with the zone highlighted.
Column Header	<p>Each header in the Text View screen identifies the information shown in each column. Touch the header and the screen will sort the values in the column by ascending or descending order. This is identified by a red line at the top or bottom of the header cell. The available parameters are as follows:</p> <ul style="list-style-type: none"> • Zone = Zone number • Name = Zone name • Setpoint = Zone setpoint • Temp = Actual temperature of zone • Power = Power output to the heater • Leakage = Earth leakage (This column is only displayed when H cards are installed and the value has been set in the System Setup screen.) • Amps = Current draw of the heater (Values in this column are suppressed for XL and HL cards) • Alarm = Alarm window (Degrees above and below the setpoint before an alarm condition is given) • Abort = Abort window (Degrees above and below the setpoint before an abort condition is given) • Regulation = Control mode (Auto = T/C control, Manual = Fixed % output, Monitor = Temperature only - No power output) • Watts = Calculated wattage of each heater (Values in this column are suppressed for XL and HL cards) • 240V W = Derated heater wattage for supply voltage vs. design voltage (Values in this column are suppressed for XL and HL cards) • VAC = Output voltage to heaters (RMS calculation for power percentage being applied to the heater) $\sqrt{\% \text{ Power}} \times \text{Input Voltage}$ (Values in this column are suppressed for XL and HL cards) • Resistance = Calculated ohm reading for each zone (Must run mold diagnostics first) (Values in this column are suppressed for XL and HL cards)
+/- Button	Touch this button to toggle between the split and full screen views. The split view configures the screen to show 48 zones in two columns to maximize the number of zones that can be seen on a page. The full view reduces the number of zones to 24, but increases the available zone parameters that can be seen. Refer to Figure 7-12 and Figure 7-11 .
Scroll Bar	Use the scroll bar to scroll between pages within a screen. If all of the available data fits in a single page, then the scroll bar will not be shown.

Table 7-6 Text View Screen Item and Button Descriptions (Continued)

Item/Button	Description
Select All	Touch this button to select all zones in the system. This will navigate to the Quick Set screen.
Clear All	Touch this button to deselect all zone.

Figure 7-12 shows the Text View screen in split-screen mode.

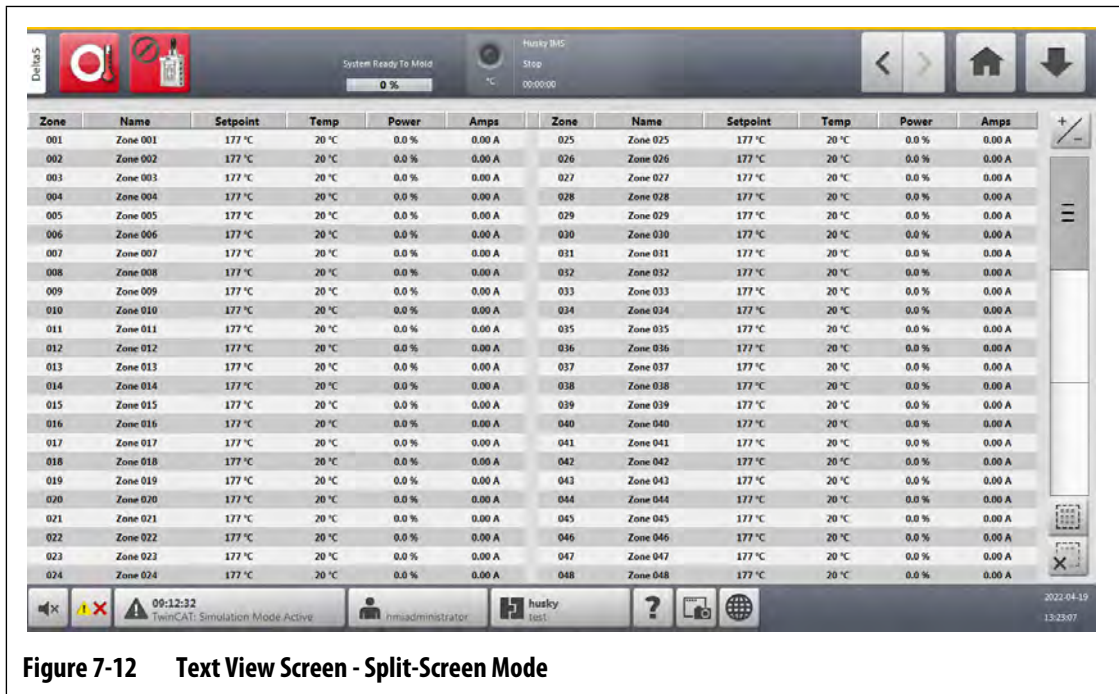


Figure 7-12 Text View Screen - Split-Screen Mode

7.6.1 Zone Selection in the Text View Screen

Use the Text View screen to select one or more zones:

- To view one zone, touch the zone row.
- To view more than one zone, touch and hold for one second the first zone, and then touch the last zone. The two zones that you selected are highlighted with all of the zones in between them.

7.6.2 Sorting

You can sort the column information on the Text View screen in ascending or descending order. Touch the header field of the column you want to sort. A red line above or below the header text identifies if the sort is ascending or descending.

Information can be sorted by the dynamic columns (for example, current [Amps], voltage [VAC], and others). This can be helpful when you want to see which zone draws the most current at any moment. The sort feature of column headers is also used in other Altanium screens.

7.7 Quick Adjustment Panel

When you select a zone, a block of zones, or touch the 'Select All Zones' button on the Neo View or Text View screens, the Quick Adjustment panel will show on the right side of the screen. This panel makes it easy for you to change frequently used parameter settings without opening the Quick Set screen.

The Quick Adjustment panel lets you change the current setpoint, zone on/off, and regulation (Auto or Manual) with the use of the buttons in the panel. You will see the zone information change immediately after a panel function is selected.

Use the buttons in the Current Setpoint area of the panel to increase or decrease the zone temperatures by 1°, 5°, or 10°. Use the buttons in the Zone On/Off area of the panel to enable or disable one or more zones. Use the buttons in the Regulation area of the panel to change one or more zones to Auto or Manual mode.

The Quick Set button, at the bottom right of the panel, will automatically open the Quick Set screen. Zones selected in the Neo View or Text View screens will also be selected in the Quick Set screen.

The Cancel button will close the Quick Adjustment panel and de-select any zones previously selected.

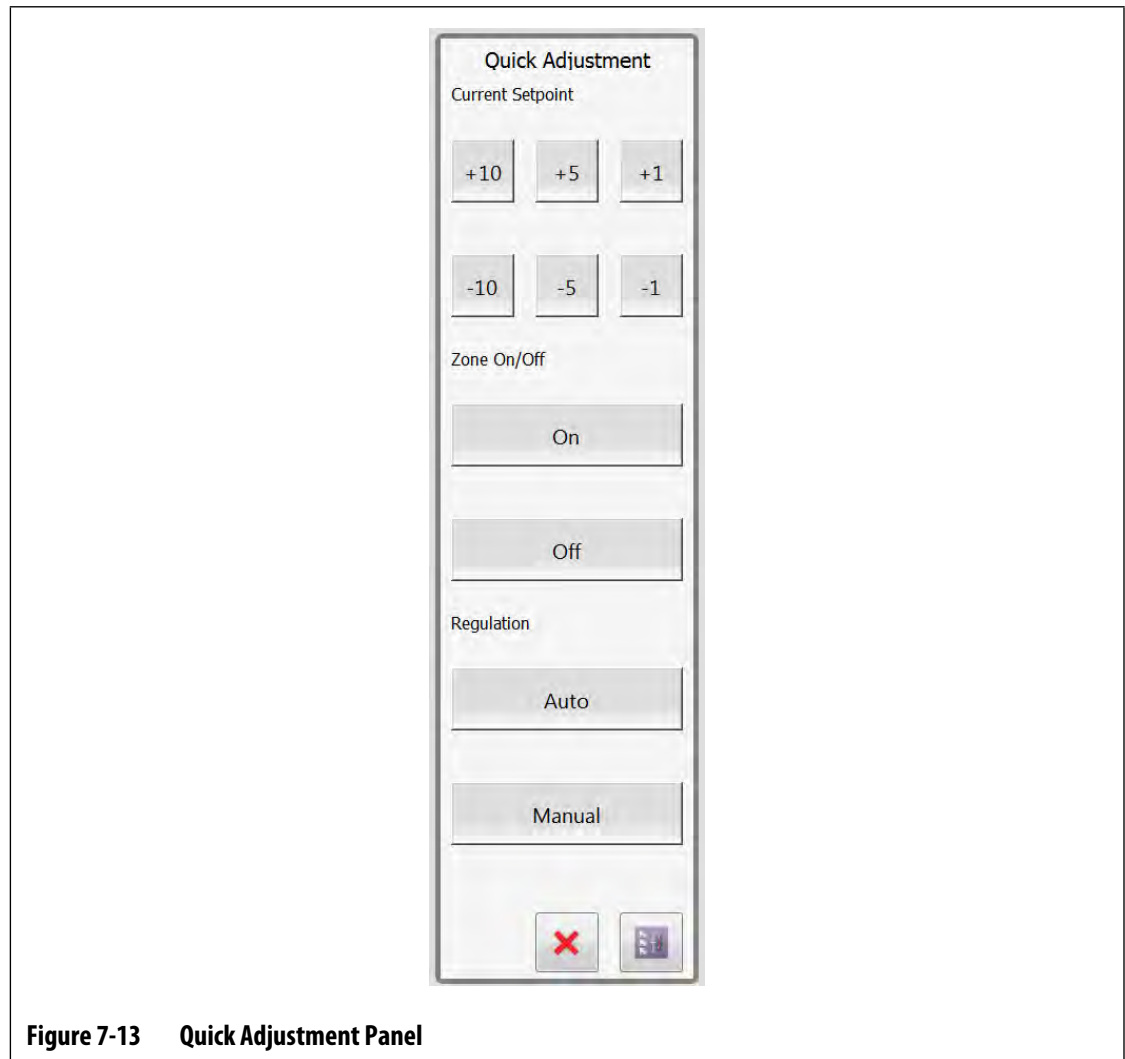


Figure 7-13 Quick Adjustment Panel

7.8 Quick Set Screen

Use the Quick Set screen to change the available zone settings and to put zones into groups. Refer to [Figure 7-14](#).

On the Home screen, touch the **Quick Set** button to see the Quick Set screen.

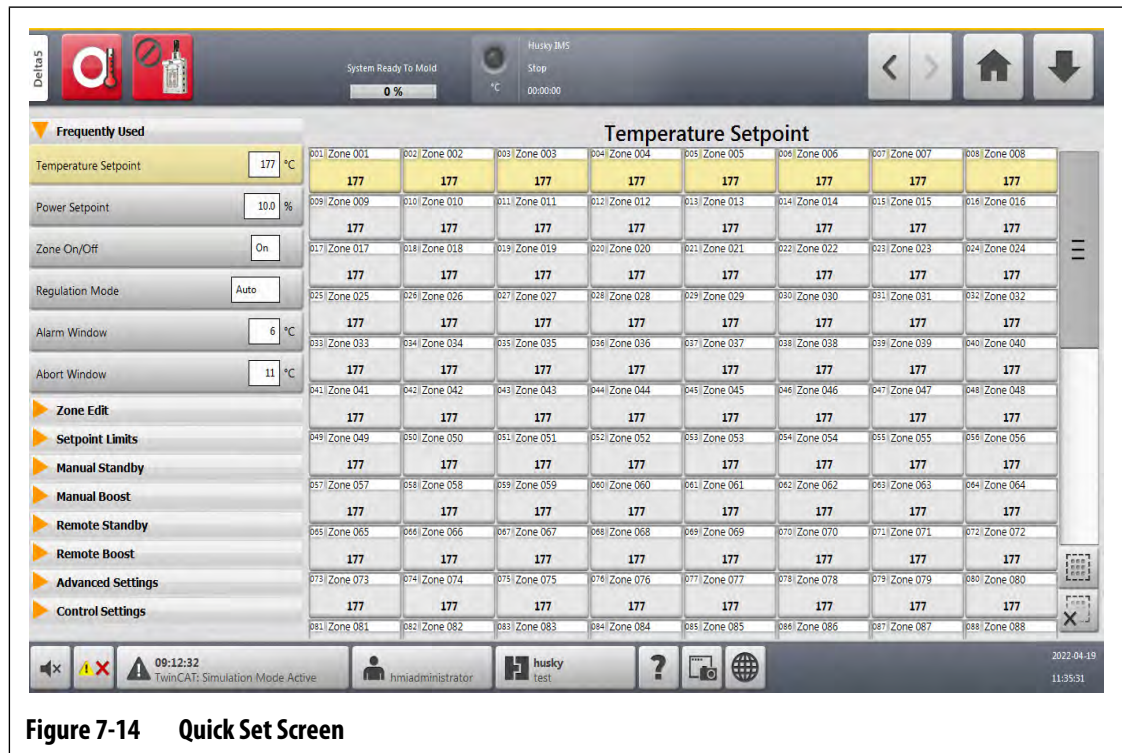


Figure 7-14 Quick Set Screen

7.8.1 Zone Setpoint Fields

On the left side of the Quick Set screen, the zone setpoint fields are organized into drop-down tabs. Touch a tab to see the fields it contains.

The setpoint fields in each drop-down tab are described in [Section 7.8.1.1](#) through [Section 7.8.1.9](#).

7.8.1.1 Frequently Used

The Frequently Used fields are described in [Table 7-7](#).

Table 7-7 Frequently Used Fields

Item	Description
Temperature Setpoint	Touch this field to set the temperature for one or more zones.
Power Setpoint	Touch this field to set the percentage of power output for one or more zones that are in Manual regulation.

Table 7-7 Frequently Used Fields (Continued)

Item	Description
Zone On/Off	Touch this field to set the selected zone(s) ON or OFF. A dialog window shows that lets you select the status. The default is ON.
Regulation Mode	Use this field to set the regulation mode for the selected zone(s): <ul style="list-style-type: none"> • AUTO or Automatic (closed loop) - the system uses a thermocouple to control the temperature. • MAN or Manual (open loop) - the system will only apply power (0 to 100%) to the heater and not use the thermocouple feedback. • MON or Monitor - the system will only monitor the temperature of a thermocouple (no power output).
Alarm Window	Touch this field to set the upper and lower alarm limits.
Abort Window	Touch this field to set the upper and lower abort limits.

7.8.1.2 Zone Edit

The Zone Edit fields are described in [Table 7-8](#).

Table 7-8 Zone Edit Fields

Item	Description
Zone Name	Touch this field to give a custom name to a zone or group of zones.
Group Name	Touch this field to give a name to a group of selected zones. When a group of zones is given a name, that name shows as a button at the bottom of the Quick Set screen. Touch a group button and the zones in the group are highlighted. All zones given a group name are used to create group views in the Multi Group View screen.
Zone Locked/Unlocked	Touch this field to lock or unlock the selected zone(s). If a zone is locked, it will prevent any changes from being made to it from the Quick Set screen.
Display/Hide Zone	Touch this field to Display or Hide the selected zone(s). If Hide is selected, the zone(s) will be removed from all the zone data view screens.

7.8.1.3 Setpoint Limits

The Setpoint Limits fields are described in [Table 7-9](#).

Table 7-9 Setpoint Limits Fields

Item	Description
Temperature Minimum	These values are the range limits in which the Temperature Setpoint field can be set.
Temperature Maximum	
Power Minimum	These values are the percentage range limits in which the Power Setpoint field can be set.
Power Maximum	

7.8.1.4 Manual Standby

The Manual Standby fields are described in [Table 7-10](#).

Table 7-10 Manual Standby Fields

Item	Description
Temperature Setpoint	The temperature to which all zones are set when the Standby button is touched. This setting can be used to lower all zone temperatures to their Manual Standby temperature setpoint until the timer completes or the user touches the Standby button again. Possible values are 0 to 500 °C or 32 to 932 °F. The default value is 121 °C or 250 °F.
Temperature Minimum	These values specify the range limits in which the Standby temperature can be set.
Temperature Maximum	
Power Setpoint	The power output to which all zones are set when the Standby button is touched. This setting can be used to lower all zone power setpoints to their Manual Standby power setpoint until the timer completes or the user touches the Standby button again. Possible values are 0% – 100%. The default value is 10%.
Power Minimum	These values specify the percentage range limits in which the Standby power can be set.
Power Maximum	

7.8.1.5 Manual Boost

The Manual Boost fields are described in [Table 7-11](#).

Table 7-11 Manual Boost Fields

Item	Description
Temperature Setpoint	The temperature to which all zones are set when the Boost button is touched. This setting raises all zones to their manual boost setpoint until the timer completes or the user touches the Boost button again. Possible values are 0 to 500 °C or 32 to 932 °F. The default value is No Change.
Temperature Minimum	These values specify the range limits in which the Boost Temperature can be set.
Temperature Maximum	
Power Setpoint	The power values to which all zones are set when the Boost button is touched. This setting raises all zones to their manual boost setpoint until the timer completes or the user touches the Boost button again. Possible values are 0% – 100%. The default value is 90%.
Power Minimum	These values specify the percentage range limits in which the Boost power can be set.
Power Maximum	

7.8.1.6 Remote Standby

The Remote Standby fields are described in [Table 7-12](#).

Table 7-12 Remote Standby Fields

Item	Description
Temperature Setpoint	Remote standby is started by a digital input signal from the Injection Molding Machine (IMM). This setting lowers all zones to their remote standby temperature setpoint until the timer completes or the input signal is off. Possible values are 0 to 500 °C or 32 to 932 °F. The default value is 121 °C or 250 °F.
Temperature Minimum	These values specify the range limits in which the Remote Standby Temperature can be set.
Temperature Maximum	
Power Setpoint	Remote standby is started by a digital input signal from the IMM. This setting lowers all zones to their remote standby power setpoint until the timer completes or the input signal is off. Possible values are 0% – 100%. The default value is 10%.
Power Minimum	These values specify the percentage range limits in which the Remote Standby Power can be set.
Power Maximum	

7.8.1.7 Remote Boost

The Remote Boost fields are described in [Table 7-13](#).

Table 7-13 Remote Boost Fields

Item	Description
Temperature Setpoint	Remote boost is started by a digital input signal from the IMM. This setting raises all zones to their remote boost setpoint until the timer completes or the input signal is off. Possible values are 0 to 500 °C or 32 to 932 °F. The default value is No Change.
Temperature Minimum	These values specify the range limits in which the Remote Boost Temperature can be set.
Temperature Maximum	
Power Setpoint	Remote boost is started by a digital input signal from the IMM. This setting raises all zones to their remote boost setpoint until the timer completes or the input signal is off. Possible values are 0% – 100%. The default value is 90%.
Power Minimum	These values specify the percentage range limits in which the Remote Boost Power can be set.
Power Maximum	

7.8.1.8 Advanced Settings

The Advanced Settings fields are described in [Table 7-14](#).

Table 7-14 Advanced Settings Fields

Item	Description
Output Power Limit	Touch this field to set the maximum percentage of power output that the system can supply to the zone(s).
Assign Leader Zone	Assigning a leader zone can be necessary when a zone's thermocouple fails during normal operation. After a leader zone is specified, the failed zone is able to continue operation. The Assign Leader Zone setting lets you use the leader zone's power output percentage for the selected zone. A value of "No Flw" means that the selected zone is not assigned to a leader zone.
Thermocouple Assignment	The number of the thermocouple to which the zone is connected.
Output Mode	Changes the power output modulation for a zone during normal operation. Choices are Zero Cross or Phase Angle.
Heater Type	Select one of the heater types that follow: None, Tips, Manifold, or Sprue. These settings are used to configure the power deviation alarm.
AMC - Automatic Manual Control	Automatic Manual Control (AMC) lets the Altanium automatically apply a manual power output percentage to a heater based on a historical average if a thermocouple fails.

Table 7-14 Advanced Settings Fields (Continued)

Item	Description
PCM - Priority Control Mode	The Priority Control Mode (PCM) controls what the controller will do in an abort condition.
Earth Leakage Check	This lets you set the earth leakage checking feature for each zone to ON or OFF.
No Heater Detected Limit	<p>Use this field to set the limit for the No Heater Detected alarm. The default is 0.20 A.</p> <p>For the system to monitor the current for a No Heater condition:</p> <ul style="list-style-type: none"> • The zone must be ON. • There are no zone errors. • The actual power value must be 10% or higher. (There are not enough pulses to calculate an accurate current value at less than 10% power.) • The actual current must be below the 'No Heater Detected Limit'. • The controller must be in a valid state: <ul style="list-style-type: none"> - Running - Standby (manual, remote, or delay) - Boost (manual, remote or delay) - Soft Start - Bake Out - Earth Leakage Check - ART - Staging

7.8.1.9 Control Settings

The Control Settings fields are described in [Table 7-15](#).

Table 7-15 Control Settings Fields

Item	Description
Control Mode	<p>Set the Control Mode to Active Reasoning Technology (ART) or Proportional Integral Derivative (PID).</p> <p>ART automatically adjusts the control algorithm applicable to different heater requirements. If a zone does not control correctly, the system you switch from the automatically adjusted ART algorithm to an algorithm that can be manually adjusted (PID).</p> <p>Refer to Section 7.9 and Section 7.10 for information on ART and PID.</p>
Output Gain	Shows the value returned by the control card for each zone after tuning is complete. Dashes are shown if the card does not return a valid value.
P-Proportional	This is the proportional term value used by the control algorithm. Possible values are: 0 – 250. Refer to Section 7.10 .

Table 7-15 Control Settings Fields (Continued)

Item	Description
I-Integral	This is the integral term value used by the control algorithm. Possible values are: 0 – 250. Refer to Section 7.10 .
D-Derivative	This is the derivative term value used by the control algorithm. Possible values are: 0 – 250. Refer to Section 7.10 .

7.8.2 Zone Name

You can give a name to each zone in the system to make it easier to find and make changes. Use names for each zone to identify a cavity, gate, probe, manifold, some other device, or an applicable area.

To rename a zone, do the steps that follow:

1. Touch the zone to be renamed.
2. Touch the **Zone Edit** drop-down tab.
3. Touch the **Zone Name** field and type a new zone name.

NOTE: Refer to [Section 7.8.2.1](#) for information about how to give a name to more than one zones.

You can also select frequently used zone names with the use of the keys that follow:

- Zone
- Probe
- Tip
- Nozzle
- Sprue
- Manifold
- Bridge
- Valve Gate
- Not Used



Figure 7-15 Zone Name Dialog Window

4. Touch the **Accept** button.

7.8.2.1 Multiple Zones Names

Use the Auto+ button to give names and numbers to two or more zones. The Auto+ button will give numbers to the selected zones from 001 to n , where n is the number of zones selected. For example, if seven zones are selected, the Auto+ button will give names to the selected zones sequentially from 001 to 007.

To give numbers and names to two or more zones, do the steps that follow:

1. Select the zones to be renamed.
2. Touch the **Zone Edit** drop-down tab.
3. Touch the **Zone Name** field and type a new zone name for all the selected zones.

You can also select frequently used zone names with the use of the keys that follow:

- Zone
- Probe
- Tip
- Nozzle
- Sprue
- Manifold
- Bridge
- Valve Gate
- Not Used

4. Touch the **Auto+** button.

7.8.3 Temperature Setpoints

The Temperatures Setpoints for each of the heaters in the mold must be specified. The default setting is 177 °C (350 °F).

To change a setpoint of a zone, do the steps that follow:

1. Touch the zone to be changed.
2. Touch the **Frequently Used** drop-down tab.
3. Touch the Temperature Setpoint field and type a new setpoint value.
4. Touch the **Accept** button.

7.8.4 Alarm Window

The Alarm Window lets you specify a range of how many degrees great than or less than the Temperature Setpoint will cause an alarm. The default Alarm Window setpoint is 6 °C (10 °F).

Alarm Example: Temperature Setpoint = 300 °F, Alarm Window = 10 °F

Temperatures greater than 310 °F or less than 290 °F will cause an alarm. If the Temperature Setpoint is changed to 350 °F, then temperatures greater than 360 °F or less than 340 °F will cause an alarm. The Alarm Window setpoint is the same number of degrees greater than and less than the Temperature Setpoint.

To change the Alarm Window for a zone, do the steps that follow:

1. Touch the zone to be changed.
2. Touch the **Frequently Used** drop-down tab.
3. Touch the **Alarm Window** field and enter a new value.
4. Touch the **Accept** button.

7.8.5 Abort Window

The Abort Window lets you set a range of how many degrees greater than or less than the Temperature Setpoint to cause an abort condition and shut down of the system. The default Abort Window setpoint is 11 °C (20 °F).

Abort Example: Temperature Setpoint = 300 °F, Abort Window = 20 °F.

Temperatures greater than 320 °F or less than 280 °F will cause an abort condition and shutdown the zone or the system as told by the PCM directive. If the Temperature Setpoint is changed to 350 °F, then temperatures greater than 370 °F or less than 330 °F will cause the abort condition. The Abort Window setpoint is the same number of degrees greater than and less than the Temperature Setpoint.

To change the abort setting for a zone, do the steps that follow:

1. Touch the zone to be changed.
2. Touch the **Frequently Used** drop-down tab.
3. Touch the **Abort Window** and enter a new value.
4. Touch the **Accept** button.

7.8.6 Output Mode

In hot runner temperature control systems, there are two different methods used to switch the power output to the heaters: Zero Cross Control or Phase Angle Control. Each method has its own set of advantages, but usually they have almost the same results.

The Altanium system lets you run each zone in one or the other mode. The default mode is Zero Cross for all zones.

To change the Output Mode for a zone, do the steps that follow:

1. On the Quick Set screen, touch the zone to be changed.
2. Touch the **Advanced Settings** drop-down tab.
3. Touch the **Output Mode** field to toggle between the Zero Cross and Phase Angle modes.

7.8.7 Zone Follow

The components that are the most sensitive to damage in the mold are the thermocouples. A thermocouple failure in a zone causes an alarm and shows an error on the Alarm screen for that zone. When this occurs, one of three operations can be done:

- Stop the mold operation, remove the mold, and repair the fault. This may not be necessary or possible to do during an injection operation.
- Change the zone to Manual control mode and continue the injection operation. This has its limits, because Manual mode cannot compensate for changes in the process that have an effect on the heater's power requirements (example: shear heat).
- Assign the defective zone (as a follower) to a different zone (leader). Because of the symmetrical operation in the design of hot runner molds, frequently there are other zones that have almost the same thermal characteristics as the defective zone. The Altanium system can apply the power output from a fully functional zone to the zone with the defective thermocouple. Process changes that have an effect on the power requirements of the heaters are automatically applied to the defective zone. This can be a temporary repair of the defective thermocouple/zone when it is not necessary to open the mold immediately.

7.8.7.1 Automatic Follow Function

If a thermocouple has a malfunction during the operation of the mold, the Altanium automatic follow function will take over. The Altanium system constantly monitors the heaters in the mold and stores the data. A zone's data is compared with other zones in the mold. This is used to select a Leader/Follower relation between two zones that are almost the same. This occurs for every zone in the mold. If a thermocouple fails, it will cause an alarm and show an error on the Alarm screen.

With the use of the compared data that the Altanium has stored, the system knows which zone to assign the defective zone to as its leader, so that it continues to operate in a closed loop control mode.

The only requirement is to see the error, then clear and reset the alarm. On the Neo View, Multi Group View, Graphical View, and Text View screens, the number toggles between the original zone number and the zone to which it follows.

After the error is cleared and reset, the follow value is written to the database. The defective zone shows its leader zone on the Quick Set screen. The automatic follow function can be disabled on the System Setup screen in the Heats Setup and Control Page 2 tabs.

If the automatic follow function cannot find an applicable zone relation, the Automatic Manual Control (AMC) function starts. If the AMC is set to ON, the system automatically changes the bad zone to Manual mode and applies a calculated average power output to the heater. If the AMC is set to OFF, the Priority Control Mode (PCM) starts and does a shutdown of the zone or the system, as controlled by the PCM directive.

7.8.7.2 Manually Assign One Zone (Follower) to a Another Zone (Leader)

If a thermocouple is about to fail, it can be assigned to a different zone (leader zone) before it fails completely.

To manually assign one zone to a leader zone, do the steps that follow:



IMPORTANT!

Select a leader zone with the same or almost the same heater characteristics. For example, a user may not want to assign a manifold zone to a tip zone. A zone cannot be assigned to itself. If a zone is assigned to itself, the Altanium will ignore the changes.

1. On the Quick Set screen, touch the zone to assign as a follower.
2. Touch the **Advanced Settings** drop-down tab.
3. Touch the **Assign Leader Zone** field and enter the zone number of the leader zone.
4. Touch the **Accept** button.

On the Neo View, Multi Group View, Graphical View, and Text View screens, the color of the manual-follower zone changes from white to dark blue and the zone and name toggles between the original zone's information and the zone to which it follows.

7.8.7.3 Regulation Mode

Each zone can run in one of three regulation modes. Refer to [Table 7-16](#). The default setting is Automatic.

Table 7-16 Regulation Modes

Regulation Mode	Description
Auto	In Automatic (closed loop) mode, the system uses a thermocouple to control the temperature.
Manual	In Manual (open loop) mode, the system will only apply power (0 to 100%) to the heater and not look for sensor feedback.
Monitor	In Monitor mode, the system will only monitor the temperature of a thermocouple (no power output).

To change the zone regulation, do the step that follow:

1. On the Quick Set screen, touch the zone to be changed.

CAUTION!

If a zone is changed to Monitor mode, the system will not apply power output to that heater.

2. Touch the **Frequently Used** drop-down tab.
3. Touch the **Regulation Mode** field.
A Regulation Mode dialog window shows with the three mode choices.
4. Touch a mode to select it, or touch the Exit icon to cancel the operation.

7.8.8 Setpoint Limits

The Altanium system lets you set temperature and power ranges in which operators cannot make changes to the setpoints that are greater than or less than the specified range limits.

7.8.8.1 Change the Normal Setpoint and Limits

On the Quick Set screen, under the Frequently Used drop-down tab, enter the temperature to heat the heaters in the mold. The default temperature is 177 °C (350 °F).

To change the operation setpoint and limits for a zone, do the steps that follow:

1. Touch the zone to change.
2. Touch the **Setpoint Limits** drop-down tab.
3. Touch the **Temperature Minimum** field and enter a temperature value.
4. Touch the **Accept** button.
5. Touch the **Temperature Maximum** field and enter a temperature value.
6. Touch the **Accept** button.
7. Touch the **Power Minimum** field and enter a percentage value.
8. Touch the **Accept** button.
9. Touch the **Power Maximum** field and enter a percentage value.
10. Touch the **Accept** button.

7.8.8.2 Change the Manual Standby and Remote Standby Setpoint Limits

There could be a condition when it is necessary to decrease the temperatures in the mold for a period of time. This is done under the Manual Standby drop-down tab (or Remote Standby drop-down tab from a remote location as an option), so it is not necessary to change the operation temperature setpoint. Set the temperatures for the heaters in the mold to cool down to when the system is in Standby (Manual and Remote). The default temperature for both the manual and remote standby setpoints is 121 °C (250 °F).

7.8.8.2.1 Change the Manual Standby Setpoint Limits

To change a Manual Standby setpoint and limits for a zone, do the steps that follow:

1. Touch the zone to be changed on the Quick Set screen.
2. Touch the **Manual Standby** drop-down tab.
3. Touch the **Temperature Setpoint** field and enter a temperature value.
4. Touch the **Accept** button.
5. Touch the **Temperature Minimum** field and enter a temperature value.
6. Touch the **Accept** button.
7. Touch the **Temperature Maximum** field and enter a temperature value.
8. Touch the **Accept** button.
9. Touch the **Power Setpoint** field and enter a percentage value.
10. Touch the **Accept** button.
11. Touch the **Power Minimum** field and enter a percentage value.
12. Touch the **Accept** button.
13. Touch the **Power Maximum** field and enter a setpoint percentage value.
14. Touch the **Accept** button.

7.8.8.2.2 Change the Remote Standby Setpoint Limits

To change a Remote Standby setpoint and limits for a zone, do the steps that follow:

1. Touch the zone to be changed on the Quick Set screen.
2. Touch the **Remote Standby** drop-down tab.
3. Touch the **Temperature Setpoint** field and enter a temperature value.
4. Touch the **Accept** button.
5. Touch the **Temperature Minimum** field and enter a temperature value.
6. Touch the **Accept** button.
7. Touch the **Temperature Maximum** field and enter a temperature value.
8. Touch the **Accept** button.
9. Touch the **Power Setpoint** field and enter a percentage value.
10. Touch the **Accept** button.
11. Touch the **Power Minimum** field and enter a percentage value.
12. Touch the **Accept** button.
13. Touch the **Power Maximum** field and enter a setpoint percentage value.
14. Touch the **Accept** button.

7.8.8.3 Change the Manual Boost Setpoints and Limits

There could be a condition when it is necessary to increase the temperatures in the mold for a period of time. This is done under the Manual Boost drop-down tab (or Remote Boost from a remote location as an option), so it is not necessary to change the operation temperature

setpoint. Set the temperatures to heat the heaters in the mold to when the system is in Boost. The default setpoint is No Chg (No Change). The No Change setpoint tells the system to make no changes to the heaters during Manual or Remote Boost.

To change a Manual Boost setpoint and limits for a zone, do the steps that follow:

1. Touch the zone to be changed.
2. Touch the **Manual Boost** drop-down tab.
3. Touch the **Temperature Setpoint** field and enter a temperature value.
4. Touch the **Accept** button.
5. Touch the **Temperature Minimum** field and enter a temperature value.
6. Touch the **Accept** button.
7. Touch the **Temperature Maximum** field and enter a temperature value.
8. Touch the **Accept** button.
9. Touch the **Power Setpoint** field and enter a percentage value.
10. Touch the **Accept** button.
11. Touch the **Power Minimum** field and enter a percentage value.
12. Touch the **Accept** button.
13. Touch the **Power Maximum** field and enter a setpoint percentage value.
14. Touch the **Accept** button.

7.8.8.4 Change the Remote Boost Setpoints and Limits

To change a Remote Boost setpoint and limits for a zone, do the steps that follow:

1. Touch the zone to be changed.
2. Touch the **Remote Boost** drop-down tab.
3. Touch the **Temperature Setpoint** field and enter a temperature value.
4. Touch the **Accept** button.
5. Touch the **Temperature Minimum** field and enter a temperature value.
6. Touch the **Accept** button.
7. Touch the **Temperature Maximum** field and enter a temperature value.
8. Touch the **Accept** button.
9. Touch the **Power Setpoint** field and enter a percentage value.
10. Touch the **Accept** button.
11. Touch the **Power Minimum** field and enter a percentage value.
12. Touch the **Accept** button.
13. Touch the **Power Maximum** field and enter a percentage value.
14. Touch the **Accept** button.

7.8.9 Change the Sensor Assignment (Thermocouple)

The Thermocouple Assignment lets the operator assign a thermocouple from a different zone to control the heater of the selected zone. This is important in a condition when there could be mis-wired thermocouples or heaters in the mold.

For example, heater number 1 may be connected to thermocouple 5 and heater number 5 may be connected to thermocouple number 1. In this example, the operator can manually switch the thermocouple inputs. Change the number in the Thermocouple Assignment field to the applicable number.

NOTE: The Altanium automatically does a check for mis-wired molds during Mold Diagnostics. This usually makes adjustments not necessary.

To change the sensor assignment for a zone, do the steps that follow:

1. Touch the zone to be changed.
2. Touch the **Advanced Settings** drop-down tab.
3. Touch the **Thermocouple Assignment** field and enter a value.
4. Touch the **Accept** button.

You also have the option to select No Sensor or Match Zone. When No Sensor is selected, the system does not use the feedback from the thermocouple to control the zone. Select Match Zone to easily match a zone with a sensor of the same number. It is typical to use the same sensor number assignment with a zone. For example, Zone 1 uses Sensor 1, Zone 2 uses Sensor 2, and the same match for other zones and sensors in the system.

7.8.10 Change the Priority Control Mode

If there is a malfunction during the heat/injection operation, the software will try to bypass the problem. If this is not possible, the system will start a shutdown sequence. You can select how the shutdown occurs.

In the case of an Abort condition, if the Priority Control Mode (PCM) is set to Zone mode, the controller stops the power output to the defective zone and continues to operate all other zones as usual. If the PCM is set to System mode, the controller will shutdown all power output to the mold (if the failure occurs on this zone). The PCM is zone selectable, so one zone may only change itself to OFF, while a different zone could shutdown the mold. The PCM is set by how critical the zone is to the mold. Usually, the cavities are set to Zone mode, and the manifolds are set to System mode. The default is System mode for all zones.

The PCM can also be set to Stage mode. In an Abort condition when Stage mode has been selected, the zones do a shutdown with a slow decrease of the temperature and power in 1 to 4 stages. The shutdown stages are configured on the Staging screen.

To change the PCM for a zone, do the steps that follow:

1. Touch the zone to be changed.
2. Touch the **Advanced Settings** drop-down tab.
3. Touch the **PCM - Priority Control Mode** field.
4. Select **Zone**, **System**, or **Stage** in the PCM - Priority Control Mode dialog window.

NOTE: To select Stage mode, the Staged Shutdown must be enabled on the Staging screen.

Optional Priority Control Mode (PCM) Digital Output

If the PCM digital output option is turned on, it will be activated only when a zone that is set to **System** mode has an abort condition. It will stay in this state until the PCM error is reset.

7.8.11 Change the Earth Leakage Check

When started, the Altanium system does a check of the earth leakage conditions on every heater in the mold. When necessary, the system will start a low voltage, phase angle bake out on the faulty zone(s) to try to bake the moisture out of the heater(s).

The Earth Leakage Check can be set to ON or OFF for each zone. The default is ON for all zones. You would have the Earth Leakage Check set to OFF only in special conditions. To change the Earth Leakage Check to OFF globally for the full system, please contact the nearest Husky Regional Service and Sales office.

7.8.12 Change the Automatic Manual Control

If there is a thermocouple malfunction during an operation, the Altanium system can automatically apply a manual power output percentage to the heater, calculated from the data information collected before the thermocouple failed. This feature is the Automatic Manual Control (AMC).

If a thermocouple fails and the AMC is set to ON, the control changes the failed zone to Manual mode and sets a manual power output, calculated from the previously recorded average power output to that heater. If the AMC is set to OFF, the control changes to PCM and does the designated task. The default setting is ON for all zones.

To change the AMC setting for a zone, do the steps that follow:

1. Touch the zone to be changed.
2. Touch the **Advanced Settings** drop-down tab.
3. Touch the **AMC - Automatic Manual Control** field.
4. Select **On** or **Off** in the AMC - Automatic Manual Control dialog window.

7.8.13 Change the Output Power Limit Setting

The Output Power Limit lets users set the maximum amount of power that can be supplied to the heaters. The default power limit for all zones is 100%.

To change the Output Power Limit for a zone, do the steps that follow:

1. Touch the zone to be changed.
2. Touch the **Advanced Settings** drop-down tab.
3. Touch the **Output Power Limit** field.
4. Type a value from 0% to 100% in the Output Power Limit dialog window.
5. Touch the **Accept** button.

7.8.14 Change the Zone Control from ART to PID

The Altanium system can automatically adjust the control algorithm to work with different heater requirements. This control method is Active Reasoning Technology (ART). In some conditions, it may be necessary to switch from the automatically adjusted ART algorithm to an algorithm that can be manually adjusted. This control method is Proportional/Integral/Derivative (PID). When you change a zone from ART control to PID control, then you can manually enter values for the Proportional, Integral, and Derivative parameters. The default control mode for all zones is ART.

To change the zone control between ART and PID, do the steps that follow:

1. Touch the zone to be changed.
2. Touch the **Control Settings** drop-down tab.
3. Touch the **Control Mode** field.
4. Select **ART** or **PID** in the Control Mode dialog window.

7.8.14.1 Change P, I or D Parameter Values

If ART has been used on a zone more than one time and could not get the required control, change the zone to PID control and adjust the three PID parameters to get the required control.



IMPORTANT!

The zone can be changed back to ART without the loss information. The default settings for all zones are:

- P = 15
- I = 10
- D = 2

To change the PID settings, do the steps that follow:

1. Touch the zone to be changed.
2. Touch the **Control Settings** drop-down tab.
3. Touch the **Control Mode** field.
4. Select **PID** in the Control Mode dialog window.
5. One selection at a time, touch the fields that contain the values for the **P**, **I**, and **D** parameters.
6. Type the new values for the P, I, and D parameters, and then touch the **Accept** button.
7. If necessary, do the previous two steps again to adjust the other PID parameters.

7.9 Active Reasoning Technology

Active Reasoning Technology (ART) is the science that applies microprocessor-based control systems to automatic system decisions. It is a control method directed at an active or continuous learning process, which is tolerant to faulty functions and incorrect operation by intentionally preventing the incorrect operation or failure.

Active Reasoning software, combined with integrated hardware, disseminates information and makes better process decisions than any modular single input, single output controller. The ability of all zones to interact with each other and understand the effects of that interaction is important. Complete automatic control is one benefit. During the Altanium startup, the control looks at each zone and then looks at comparisons of all zones and finds any interaction between them. It tests for earth leakages in each zone and as a whole. It then makes the necessary bake out and soft start routines to do an even and correct heat of the mold.

7.9.1 ART Process Screen

The **ART Process** screen is used to start the Active Reasoning Technology self-tuning process and monitor its progress. Refer to [Figure 7-16](#).

This screen shows automatically after you touch Start if one or more zones in the current loaded mold setup has not completed the ART process. The process can be manually started for zones that the system sensed are not controlled correctly.

When ART is in operation, the system cannot be changed with the Start, Standby, or Boost buttons. Touch the **Cancel Art** button to go back to usual operation or touch the **Stop** button to cancel the ART process and stop the controller. Navigation is disabled until the ART process completes. Zones that have not completed the ART process will go through the process again the next time the system is started.

Descriptions for the ART Process screen are given in [Table 7-17](#), [Table 7-18](#), and [Table 7-19](#).



Figure 7-16 ART Process Screen

Table 7-17 ART Process Screen Item Descriptions

Item	Description
Status Text	The ART status is shown at the top of the screen.
Zone Selection Grid	<p>The selection grid shows the status of each zone.</p> <p>Yellow highlight shows a zone that is selected.</p> <p>A yellow caution triangle marks a zone that cannot have the ART process started (for example, a zone set to manual regulation mode or a zone with errors).</p> <p>An hourglass shows that ART is in progress.</p> <p>A green check mark shows that a zone that has completed the ART process.</p> <p>A question mark shows a zone that has not completed the ART process.</p>

Table 7-18 ART Process Screen Button Descriptions



Button	Description
	<p>Start ART Process</p> <p>Starts the ART process.</p>
	<p>Cancel ART Process</p> <p>Stops the ART process.</p>

Table 7-18 ART Process Screen Button Descriptions (Continued)



Button	Description
	<p>Reset ART Process</p> <p>Resets the ART parameters for the selected zones. The next time the system is started, it will do the ART process on those zones again.</p>
	<p>Edit ART Values</p> <p>Opens the Edit ART Values dialog window to see or change the ART parameters. ART values can be changed one zone at a time, while the controller is in operation.</p>

Table 7-19 ART Status Descriptions

Symbol	Description
?	The question mark shows the ART process has not been started or a zone has not been through the ART process.
X	The X shows there is a problem with the zone. This problem will not let the ART process start.
Hourglass	An hourglass shows that the ART process is in operation.
Check mark	A check mark indicates that the ART process is complete.

7.9.1.1 Manual ART Function

If there is a change to a zone, such as the replacement of a heat element or thermocouple, it could be necessary for an operator to reset the ART parameters for that zone. Poor control of the zone could also cause an operator to do the reset. For example, the temperatures go over and under the setpoint, but this does not trigger an alarm. This is not to be confused with shear heat from the material, which shows as sudden increases in temperature with no undershoot.

After the system is started, the ART process automatically starts on all zones that have not yet gone through the ART process. If a zone is not controlled correctly when it gets to its setpoint, ART can manually be run on that zone.

When ART is run manually on a zone, the Altanium system deletes its knowledge base on that zone and recalculates the control process. It then stores this data and uses it to calculate the correct output to control this zone best at setpoint. Use this function carefully and only let approved individuals use it. The molding process may be interrupted if ART is run on several zones at one time, but this would be an unusual condition. It is best to run ART on a zone when it is at the temperature setpoint.

To manually use ART on a zone, do the steps that follow:

NOTE: The system must be in RUN mode before the ART process can start.

1. On the ART Process screen, select the zone or zones on which the ART process will manually be run.
2. Touch the **Start ART Process** button to start the ART analysis on the selected zone(s).
As each zone completes the ART process, a green check mark shows for that zone.

To cancel the ART process during its operation, touch the Cancel ART Process button.

7.9.2 ART 2.0

The use of the ART 2.0 tuning strategy gives added performance in comparison to ART classic. With ART 2.0, the system is ready to mold much faster than before, with the advantages that follow:

- Faster mold-tuning
- Reduced risk of tune-failure
- Reduced risk of mold-setup error
- Improved heating strategies
- Reduced dependence on local tuning skill
- Automatic zone classification

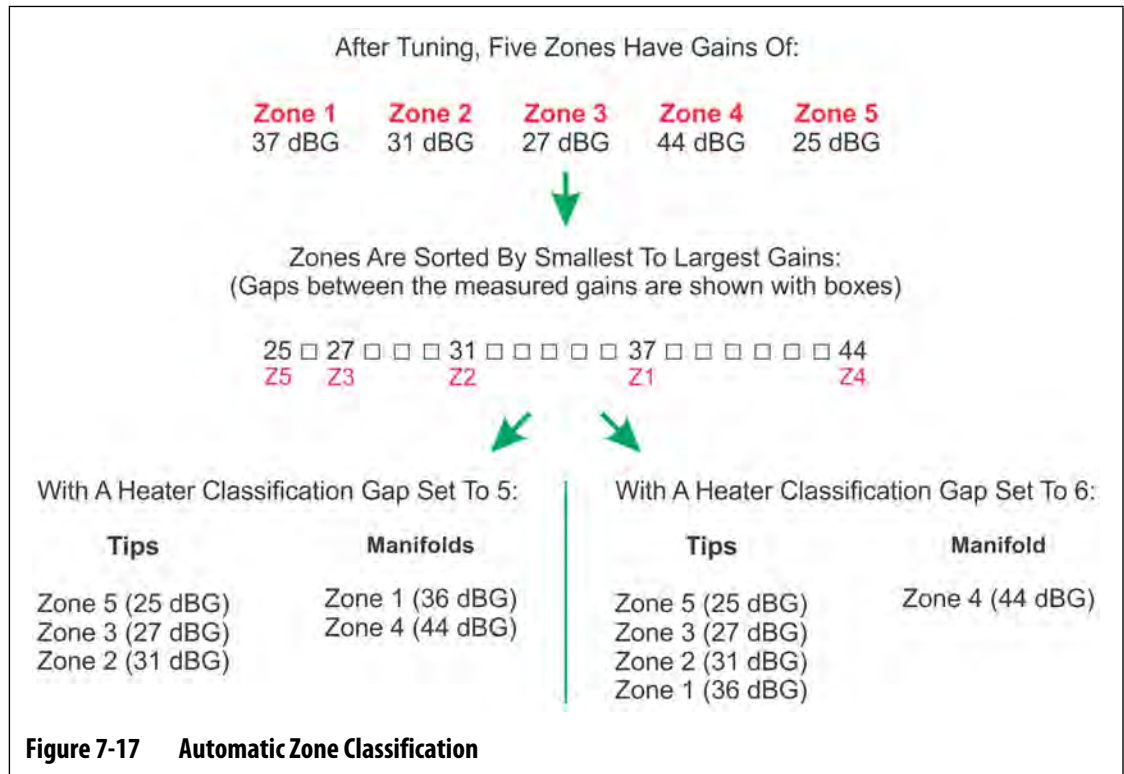
With ART 2.0, there is a shorter time to restart through improved heat-up strategies with the potential to reduce resin degradation, which could save some material, time, and energy.

The system is able to automatically classify the type of heater that each zone controls with the use of the ART 2.0 algorithms. In the System Setup screen, you can enter a Heater Classification Gap that determines which zones are tips and which ones are manifolds.

A heat capacity value, measured as zone gain in decibels (dBG), is returned by the control card that can be used for determining the heater type. Values for all the zones are sorted in ascending order and then the widest gap found between zones is determined. If the widest gap exceeds the Heater Classification Gap, then the zones on the lower side of the gap are tips and the other zones are manifolds. If no gap is wide enough, then no action can be taken because the system cannot determine a tip from a manifold.

For typical hot runners a value of 5 dBG or 6 dBG is ideal, but there could be specialized molding applications where these defaults are not applicable.

[Figure 7-17](#) shows examples of how the classifications (tip/manifolds) are determined. The gains of five zones are measured. The gains are sorted from smallest to the largest with gaps shown between the gains. With the use of the Heater Classification Gap value that you enter in the Heats Setup (Control Page 3) of the System Setup page, ART 2.0 counts the gaps between the measured gains and assigns each zone a tips or manifold classification. With a Gap setting of 5, zones with lower gain measurements (and separated by 4 gaps or less) are tips, while zones with higher gain measurements (and separated by 5 gaps or more) are Manifolds. With a Gap setting of 6, zones with lower gain measurements (and separated by 5 gaps or less) are tips, while zones with higher gain measurements (and separated by 6 gaps or more) are Manifolds.



A dialog window is shown after the tuning is complete for a new mold setup or if one or more zones have been re-tuned on a different mold. This is only if the heater types have changed.

NOTE: This dialog will not show if the system cannot find a gap between zones wider than the Heater Classification Gap setting in System Setup. The system is unable to determine a tip from a manifold during the tuning process.

In the dialog window, the zones are shown with their determined classifications. All zones are selected by default. If you touch the Accept button, the system will store the tips and manifold zones that it determined. The classifications are stored in the Mold Setup for later reference. You can also deselect or reselect zones to customize which ones are automatically classified. If you touch the Exit button, then no automatic classification will occur.

7.10 PID Control

The sections that follow give typical PID values and possible causes of oscillation.

7.10.1 Typical PID Values

A list of some typical PID values is given in [Table 7-20](#).

Table 7-20 PID Values

Proportional	Integral	Derivative	Type	Example
015	010	002	Fast	Probes or heaters with internally located thermocouples
050	020	000	Fast	
020	010	000	Fast	
015	015	000	Fast	
020	007	100	Medium	Probes or heaters with internally located thermocouples (larger mass)
020	005	200	Medium	
100	003	000	Slow	Manifolds or heaters with externally located thermocouples
075	003	150	Slow	

7.10.2 Possible Causes of Oscillation

It is possible to set the control terms incorrectly, which could cause an oscillation. [Table 7-21](#) gives the most common causes.

Table 7-21 Possible Causes of Oscillation

Cause	Description
"P" too large	Power change is too great with the degrees of temperature change.
"I" too large	Power changes too quickly for the process to follow it.
"D" too large	Stepped power change too large for the rate of change of temperature.
Shear	An important issue often overlooked is the effect of shear in the material as it passes through the gating area. This can cause an increase in temperature in excess of 33 °C (60 °F) under severe conditions. Thus, if large temperature variations occur during molding, it is worth plotting this variation against the molding cycle time. As the controller cannot start additional cooling, it is only possible to minimize this effect with correct PID term selections.

Chapter 8 Mold Diagnostics

Mold diagnostics is used to troubleshoot problems with a mold and to make sure that the wiring integrity of a mold after maintenance has been done. Diagnostics can also be used to analyze the thermal isolation between all the cavities in the mold.

8.1 Testing the Mold

To test the mold, do the steps that follow:

1. On the Home screen, touch the **Mold Diagnostics** button.
The Mold Diagnostics screen shows. Refer to [Figure 8-1](#).
2. Make sure that the Altanium system is in the Stop state.
3. Select the zone(s) to be tested.
4. Select the checkbox(es) for the test(s) to be done.
5. Touch the **Run Test** button.



Figure 8-1 Mold Diagnostics Screen

1. Run Test 2. Stop Test 3. View Test Results

The Mold Diagnostic screen fields, selections, and buttons are described in [Table 8-1](#).

Table 8-1 Mold Diagnostics Screen Field and Button Descriptions

Field/Button	Description
Validate Zone After	The number of degrees that a zone must heat above its start temperature to pass a test.
Zone Cooling Time	The amount of time to wait after a test completes before the system starts the next test.
Maximum Test Time	The maximum test duration.
Heaters (test)	<p>In the Select Tests panel of the screen, select the Heaters checkbox to do the heater current draw test of the selected zones. The Heaters test:</p> <ul style="list-style-type: none"> • Records the maximum current and voltage, and then calculates the resistance. • Does a test for open fuses.
Sensors (test)	<p>In the Select Tests panel of the screen, select the Sensors checkbox to do the thermocouple sensor test of the selected zones to make sure that the thermocouples function correctly. The test makes sure that the sensor is not lost or has its wiring reversed.</p>
Wiring (test)	<p>In the Select Tests panel of the screen, select the Wiring checkbox to do a thermocouple and heater pairings test for the selected zones. The test makes sure the pairings are correct, such as 1 to 1, 2 to 2, and so on. The wiring test does what follows:</p> <ul style="list-style-type: none"> • Before the Altanium does the cross talk test, it waits for the temperature to be below the threshold for the cross talk test. • As the mold heats, the system records the maximum current and voltage, and then calculates the resistance. • Makes sure all cross talk is works correctly.
Run Test (button)	Touch the Run Test button to start the selected tests. The tests are done only on the selected zones.
Stop Test (button)	Touch the Stop Test button to stop the test. The results for completed tests are recorded in the database. The test results can be reviewed at a later time.
View Test Results (button)	Touch the View Test Results button to open the Test Results screen. This can be done during the test after the first zone has completed or after the test has completed.
Test Status	The field shows the current status of the test. During the test, it shows the zone test operation.
Start Time	The time that the test was started.
Elapsed Time	The amount of time that has elapsed since the test was started.

8.1.1 Run a Mold Diagnostics Test

To do a mold diagnostic test, do the steps that follow:

1. Before power is connected to the controller or the mold, clean the mold and area around it.

CAUTION!

Risk of damage to the equipment — Some molds may not be correctly grounded through the mold cables. Use a length of applicable wire to attach the mold to the mold ground connector on the Altanium mainframe.

2. For safety, make sure that the controller and mold share the same ground.
3. Check the mold wiring to make sure that there are no bare wires, frayed ends, or cut insulation.
4. Connect all thermocouple and power cables from the controller to the mold, and make sure that the connectors are attached correctly.
5. Connect the Altanium mainframe to the main input power and energize the system from the main disconnect.
6. Log into the Altanium and load a mold setup.
7. Make sure that the zones that will have the test done are in the ON state. Any zones that are in the OFF state will not have the test done.
8. On the Home screen, touch the **Mold Diagnostics** button.
9. Select the zone(s) that will have the mold diagnostic test.
10. Select the test(s) to do (Heaters, Sensors, and/or Wiring). By default, all tests are selected.
11. Touch the **Run Test** button.

8.1.2 Set the Zone Cooling Time

On some molds, it may be necessary for the Altanium controller to wait some time before the start of a test on the next zone. For example, more time is necessary in a condition when a thermocouple continues to heat for some time after the power has been removed. This can occur with large manifolds. If a zone completes a test and is not given time to let the temperature stop its increase, it can have an effect on the results of the next zone that starts its test immediately after.

To set the zone cooling time, do the steps that follow:

1. On the Mold Diagnostics screen, select the zone(s) to change.
2. Touch the **Zone Cooling Time** field.
3. Enter the zone cooling time in the HH:MM:SS format.
4. Touch the **Accept** button.

NOTE: The Zone Cooling Time default is 10 seconds. Each mold setup can have its own set of delay times.

8.1.3 Set the Maximum Test Time

On some molds, if there is a thermocouple wiring problem, a heater could be damaged during test. Heaters in some configurations may not support the peak temperatures in the default test time when full power is applied. An example could be a test on a hot runner without the cavity plate in position.

If a heater is large, a short test time is not long enough to heat up and can result in a failed test. Operators can set the maximum test time for each zone to work with different types of heaters.

To set the maximum test time, do the steps that follow:

1. On the Mold Diagnostics screen, select the zone(s) to change.
2. Touch the **Maximum Test Time** field.
3. Enter the maximum test time in the HH:MM:SS format.
4. Touch the **Accept** button.

NOTE: The Maximum Test Time default is 2 minutes. Each mold setup can have its own set of maximum test times.

8.2 Diagnostics Results

To review the diagnostic test results, do the steps that follow:

On the Home screen, touch the **Diagnostics Results** button to open the Test Results screen. Refer to [Figure 8-2](#).

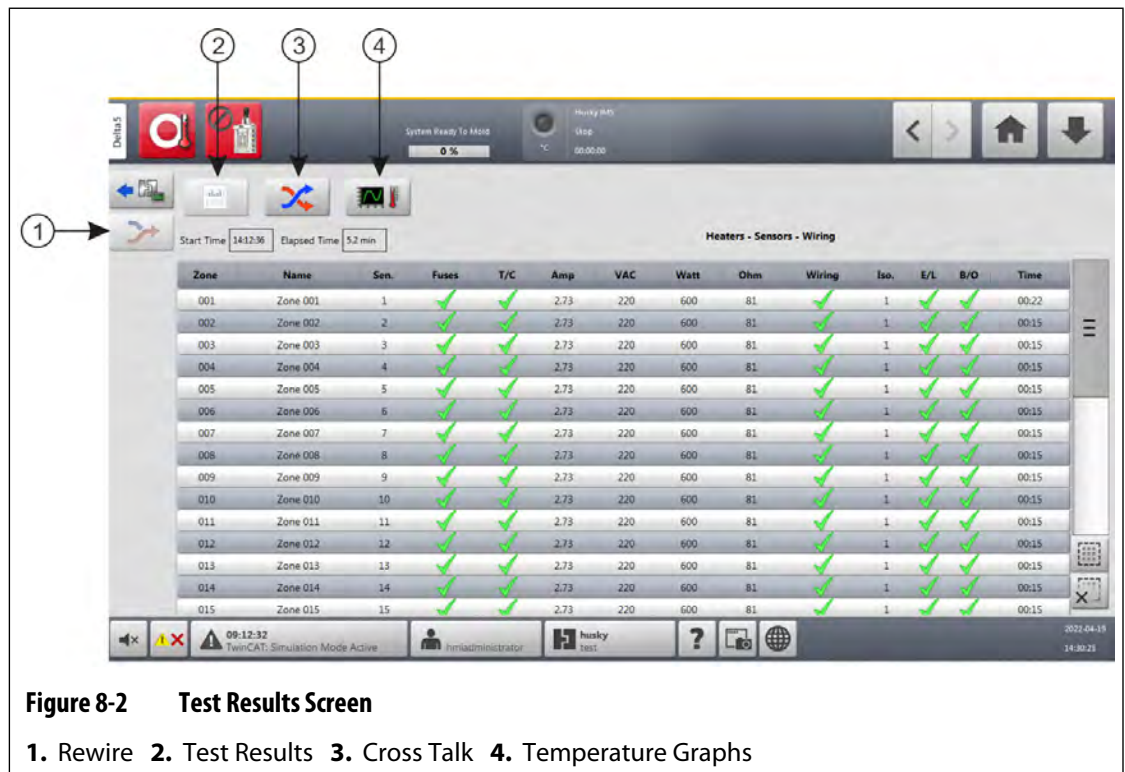


Figure 8-2 Test Results Screen

1. Rewire
2. Test Results
3. Cross Talk
4. Temperature Graphs

The buttons and fields on the Test Results screen are described in [Table 8-2](#).

Table 8-2 Test Results Screen Buttons and Fields

Item	Description
Mold Diagnostics	Opens the Mold Diagnostics screen.
Rewire	Automatically reassigns all the sensors to their correct location with the use of the test results.
Test Results	Opens the Test Results screen from the Cross Talk and Temperature Graphs screens.
Cross Talk	Opens the Cross Talk screen.
Temperature Graphs	Opens the Temperature Graphs screen.
Start Time	The time the test was started.
Elapsed Time	The elapsed time of completed test.

8.2.1 Test Results Screen Values

The test result columns are described in [Table 8-3](#).

Table 8-3 Test Result Columns

Item	Description
Zone	Shows the zone number.
Name	Shows the zone name.
Sen.	Identifies the number of the sensor that is used for that zone.
Fuses	The fuses test shows if the fuse for that zone operates correctly. The fuse values are shown as follows: <ul style="list-style-type: none"> Question Mark: the fuse test for the zone was not done. Check Mark: shows the fuse for the zone completed the test satisfactorily. X: shows a failure of the fuse test for the zone.
T/C	The thermocouple test shows if the thermocouple for that zone operates correctly. The thermocouple values are shown as follows: <ul style="list-style-type: none"> Question Mark: shows the thermocouple test for the zone was not done. Check Mark: shows the thermocouple for the zone completed the test satisfactorily. X: shows a failure of the thermocouple test for the zone, because it was reversed or lost.
Amp	Current drawn by the heater during the test for each zone.
VAC	Line voltage reading during the test for each zone.

Table 8-3 Test Result Columns (Continued)

Item	Description
Watt	Power for each zone that was calculated from the line voltage and current readings measured during the test.
Ohm	Resistance for each zone that was calculated from the line voltage and current readings measured during the test.
Wiring	<p>The wiring test does a check for correct zone sensor assignment. This test makes sure that the sensor assignments match. If a sensor assignment does not match, there will be a failure of cross talk findings test. Wiring values are shown as follows:</p> <ul style="list-style-type: none"> • Check Mark: shows the zone completed the wiring test satisfactorily. • X: shows a failure of the zone wiring test.
Iso.	<p>This test calculates cross talk data that is used to describe if a zone is correctly isolated from adjacent zones. When heat is applied to a zone, the adjacent zone temperatures must not increase. Isolation values are shown as follows:</p> <ul style="list-style-type: none"> • 1 = Excellent isolation • 2 = Good isolation • 3 = Moderate isolation • 4 = Fair isolation • 5 = Poor isolation
E/L	<p>The earth leakage test does a check for a earth leakage in each zone. Earth leakage values are shown as follows:</p> <ul style="list-style-type: none"> • Question Mark: shows the earth leakage test for the zone was not done. • Check Mark: shows there is no earth leakage for that zone. • X: shows there is earth leakage for that zone.
B/O	<p>The bake out test does a check for moisture in each heater. Bake out values are shown as follows:</p> <ul style="list-style-type: none"> • Question Mark: show the bake out test for that zone was not done. • Check Mark: shows the zone completed the bake out test satisfactorily. • X: shows a failure of the zone bake out test.
Time	Time taken to test each zone.

8.2.2 Automatic Thermocouple Rewiring

Thermocouples can be accidentally cross-wired in the mold, where the thermocouple for one heater becomes connected with a different heater.

The Altanium wiring test does a check of the thermocouple/heater wiring and shows if the wiring is correct. When the test is complete and if an error was found, the zone with the error will show an X in the Wiring column. Also, the Re-Wire button on the Test Results screen will be enabled.

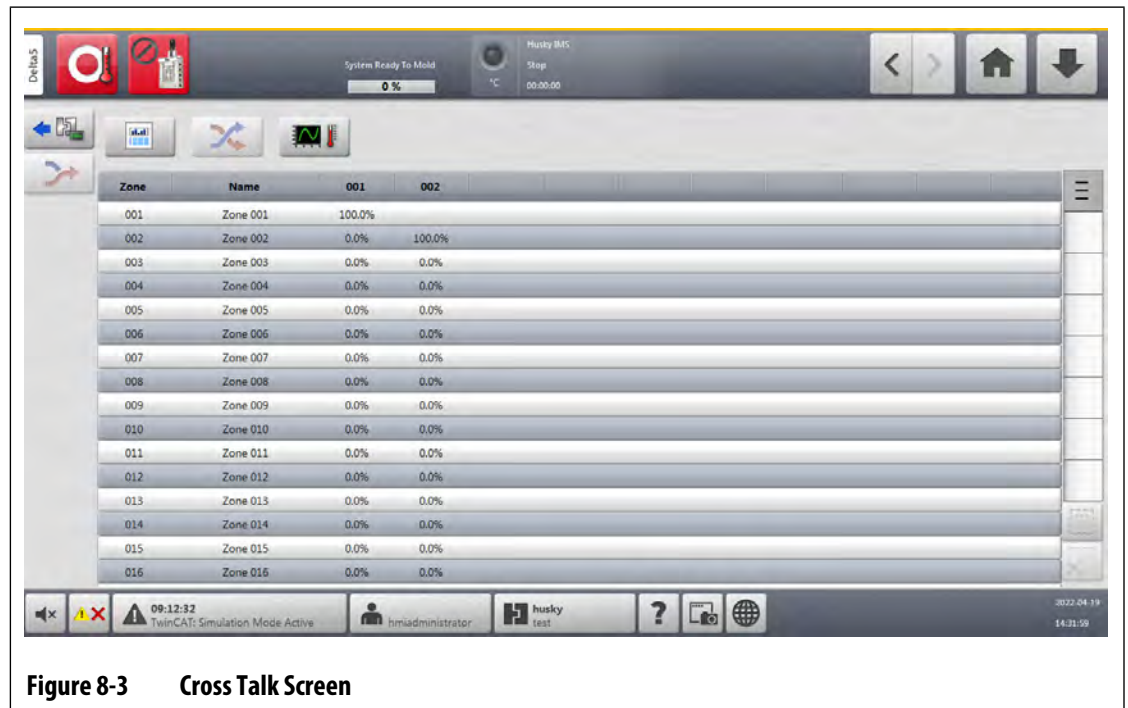
To automatically rewire thermocouples, touch the **Re-Wire** button on the Diagnostics Results screen. The system reassigns the mold thermocouples to their correct zones.

NOTE: This rewire information is saved with the mold setup.

8.3 Cross Talk Screen

Use the Cross Talk screen to see how much heat transfer occurs between the zones in the mold. Refer to [Figure 8-3](#). A zone in a correctly wired mold with no thermal isolation issues will show 100%, while all other zones will show 0%.

For example, Zone 9 completes the test and shows 100%, but Zone 10 shows 60%. If Zone 9 increased its temperature by 10° during the test, Zone 10 increased 60% of the 10°, or 6°, without added energy applied.



The column information of the Cross Talk screen is described in [Table 8-4](#).

Table 8-4 Cross Talk Screen Column Information

Item	Description
Zone	Shows the zone number.
Name	Shows the name of the zone.
Cross Talk	Shows the percentage of cross talk between zones.

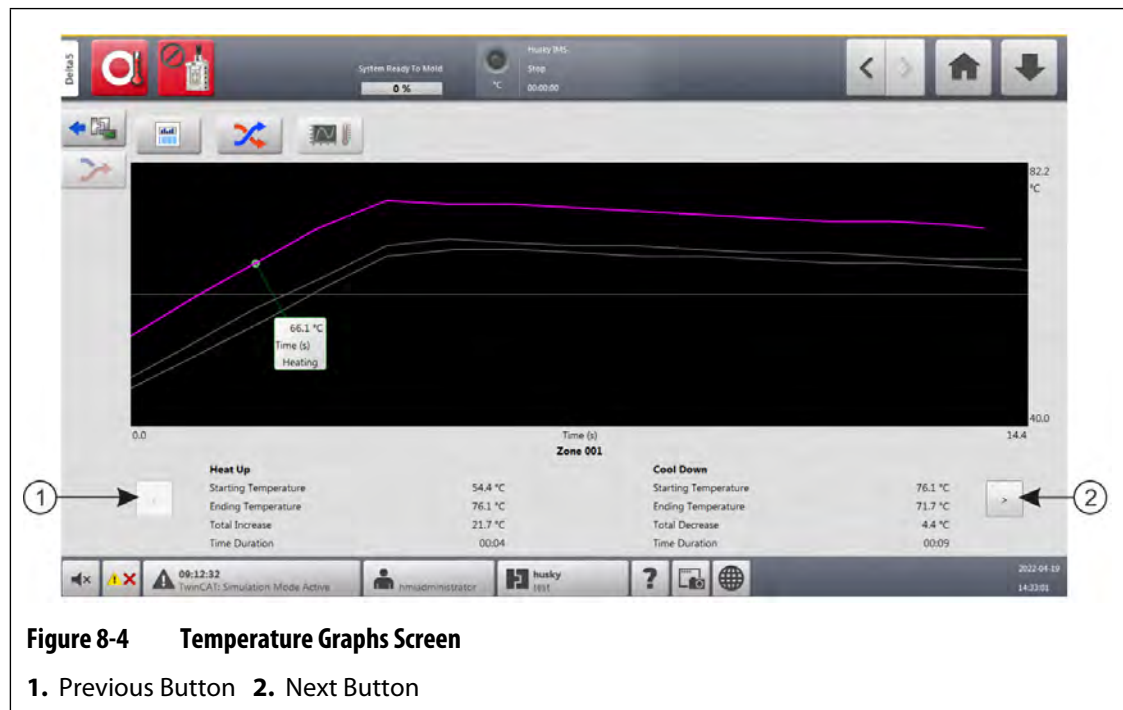
To see the cross talk information, do the steps that follow:

- On the Test Results screen, select the zones to compare.
 - NOTE:** A maximum of 10 zones at a time can be selected and compared.
- Touch the **Cross Talk** button.

8.4 Temperature Graphs Screen

The Temperature Graphs screen has a graphical trace for each zone that shows the temperature rise during the full test. Refer to [Figure 8-4](#).

To open the Temperature Graphs screen, touch the **Temperature Graphs** button on the Test Results screen.



The Temperature Graphs screen buttons are described in [Table 8-5](#).

Table 8-5 Temperature Graphs Screen Button Descriptions

Button	Description
Previous Arrow	Shows the results of the previous zone if multiple zones are selected.
Next Arrow	Shows the results of the next zone if multiple zones are selected.

The Heat Up and Cool Down indications for the Temperature Graphs screen are described in [Table 8-6](#).

Table 8-6 Temperature Graphs Screen Indications

Item	Description	
Temperature Graph Area	<p>The temperature graph area shows the recorded temperature rise during the test period for the selected zone. Touch the graph line to display the temperature and status of the location touched.</p> <ul style="list-style-type: none"> The purple trace line in the graphic area of the screen shows the zone temperature information during the Heat Up and Cool Down stages of the test. The grey trace lines in the graphic area of the screen show the other zones that you selected. Touch the Previous Arrow and Next Arrow buttons to see the temperature test results for those zones. 	
Heat Up	Starting Temperature	The temperature of the zone at the start of the heat up stage of the test.
	Ending Temperature	The temperature of the zone when the zone completed the heat up stage of the test.
	Total Increase	The increase in temperature of the zone as it was heated.
	Time Duration	The time to heat the zone.
Cool Down	Starting Temperature	The temperature of the zone at the start of the cool down stage of the test.
	Ending Temperature	The temperature of the zone at the end of the cool down stage of the test.
	Total Decrease	The decrease in temperature of the zone during the cool down stage.
	Time Duration	The time to cool the zone.

Chapter 9 Heat the Mold

This chapter describes how to start the Altanium system, and check for errors and alarm conditions if they occur.



WARNING!

Please read this entire manual before you start the system. Call the nearest Husky Regional Service and Sales office with any questions.

With all of the Altanium-to-mold connections completed and the mold cooling is ON, touch the **Start** button to start the system.

9.1 Heater Circuit Test

9.1.1 Startup

On startup, the H cards do a heater circuit test on all zones before full power is applied. This is to minimize risk of damage to the controller or hot runner system. The time for this test is 18 seconds and is done before the Soft Start is started. Refer to [Section 9.6](#) for information on the Soft Start.

This heater circuit test is very important in that it detects the heater circuit faults. [Table 9-1](#) gives the descriptions of the heater circuit faults.

Table 9-1 Heater Circuit Faults

Faults	Description
Open Circuit	Occurs when a conductor is broken or becomes loose and no current flows through its related circuit.
Short Circuit	Occurs when current flows through an incorrect circuit or directly to ground as the result of a wiring error across the heater outputs, a pair of frayed conductors, or a crimped wire.
Leakage	A low current short to ground that usually occurs when moisture is absorbed by a heater's insulation material.
Wrong Heater	When the heater would apply more than the heat capacity of the zone it is connected to in the controller.

9.2 Earth Leakage/Wet Heater Bake Out System

The Altanium is equipped with an Earth Leakage/Wet Heater Bake Out system. When the system is started, the Altanium continuously does checks for earth leakage conditions on all heaters in the mold at the same time. When necessary, the system starts a low voltage bake out on the zones that have earth leakage failures to try to bake the moisture out of the heaters.

9.2.1 Earth Leakage Limit

For X Cards (ICC²):

- The system shows an earth leakage error if the percentage is over the user specified percentage limit, or if a zone has not gone through diagnostics, based on a default value of 0.2 amps.
- The system shows a bake out error if the amperage is not below the user specified Bake Out Limit with a default value of 0.2 amps and an adjustable range from 0 to 5 amps. A value of 0.2 amps or higher, but lower than the earth leakage limit, will trigger a bake out error.
- The calculated earth leakage limit or the default value is compared to the minimum limit and the lower of the two values is applied.

For H Cards (ICC³):

- The cards include a sensor to continuously monitor leakage current in the heater circuit. The system will show an earth leakage error based on the user specified Earth Leakage Fault Limit with a default value of 500 milliamps and an adjustable range from 1 to 999 milliamps.
- The system will show a bake out error based on the user specified Bake Out Limit with a default value of 200 milliamps and an adjustable range from 1 to 999 milliamps. Any value of 200 milliamps or higher, but lower than the earth leakage limit, will trigger a bake out error.

9.2.1.1 Set the Earth Leakage Limit

To set the earth leakage limit, do the steps that follow:

1. On the Home screen, touch the **System Setup** button.
2. On the System Setup screen, touch the **Heats Setup** tab and then the **Monitoring 1** tab.
3. In the Earth Leakage panel of the screen, touch the **Earth Leakage Limit** field.
4. Type a limit value.
5. Touch the **Accept** button.

NOTE: For ICC² cards, the value is entered as a percentage that is used to calculate the earth leakage limit when the diagnostic operation for a zone is complete. The range is from 0 to 100% with a default value of 10%. For ICC³ cards, the value is entered in milliamps. The range is from 1 to 999 mA with a default value of 500 mA.

9.2.2 Configure the Length and Number of Bake Out Cycles

The low-voltage bake out operation will run up to five cycles, if necessary. The time for each cycle can be set from one to 30 minutes. The system mode and system timer shows each bake out cycle that is in progress.

When a bake out cycle is complete, the system decides to do the bake out cycle again, if necessary. If the Bake Out Alert Enable parameter is ON and moisture stays in the system after the selected number of bake out cycles have completed, the system automatically does a shutdown and triggers a bake out alarm. If there is no moisture in the system after the selected number of bake out cycles have completed, the soft start operation starts.

To configure the length of each bake out cycle, do the steps that follow:

1. On the Home screen, touch the **System Setup** button.
2. On the System Setup screen, touch the **Heats Setup** tab and then the **Control Page 1** tab.
3. In the Bake Out panel, touch the **Bake Out Time Per Cycle** field.
4. Enter the desired value.
5. Touch the **Accept** button.

To configure the number of bake out cycles, do the following:

1. In the Bake Out panel, touch the **Number of Bake Out Cycles** field.
2. Type the number of cycles.
3. Touch the **Accept** button.

9.3 AltaStart

The AltaStart function is used for heat sequencing. This system analyzes the likely heat-up time of tip zones and scheduling each one to make sure that they get to their respective temperature setpoints within 3 minutes of the manifolds. When AltaStart is used:

- Zones that are turned OFF will not be included in the AltaStart process.
- Zones in manual regulation will use a scaled power value during the AltaStart process, similar to soft start.
- The Heater Type setting must be set to Tip or Tips for the AltaStart process to operate correctly.
- The tips zone must wait at least 180 seconds (3 minutes) before determining when to start heating. This is done in case the manifold zones become power saturated and it takes longer for them to heat up.

9.4 UniStart

The UniStart function provides the shortest start-up time while ensuring that all temperatures track to their setpoint.

NOTE: If AltaStart is enabled, only non-tip zones will be included in the UniStart process. If AltaStart is not enabled, then all zones will be included in the UniStart process.

When the Delta5 Start button is select, the system operates as follows:

1. Fast heating is applied if enabled. Refer to [Section 9.5](#).
2. The lowest common Integral value (of PID) between all the zones is determined and is shared with the other zones.
3. The global ramp limit is shared with all the other zones.
4. The zones in the UniStart process will no longer use the Ramp Limit or common Integral when they enter the At Temperature window (refer to [Section 7.8.4](#)). The previous Integral value will be restored.

The system does a check for power saturation during the heat process:

- If some zones have a power that is within 4% of the present power limit, the same threshold as No-Response, it will be considered saturated. The zone with smallest delta from the limit will be the lead zone.
- The present ramp of the UniStart group's lead zone should be shared among all of the zones in the group. This sharing is similar to that of sharing the Integral except that the value is likely to change while heating. This value will persist for as long as the zone is under UniStart control. As zones enter At-Temperature, all limits are lifted.

9.5 Fast Heating

The UniStart process heats the zones slowly, but evenly. When Fast Heating feature is enabled, the system pushes some zones to heat faster, as follows:

- The system looks at all the zones to see if the Integral value (of PID) is less than 2. If it is, then the value is changed to the lesser of either:
 - Twice its normal value, or a value of 2.
 - The Proportional (of PID) is then multiplied by a fraction. The fraction is the old Integral value divided by the new Integral value.

Example 1: A zone's ART PID values are 15.0, 1.2, and 1.4. The system will change the integral value to 2 and multiply the proportional value by $1.2 / 2$ or 0.6.

Then $15 \times 0.6 = 9$. The new PID values then become 9.0, 2.0, and 1.4.

Example 2: A zone's ART PID values are 15.0, 0.6, and 1.4. The system will change the integral value to 1.2 and multiply the proportional value by $0.6 / 1.2$ or 0.5.

Then $15 \times 0.5 = 7.5$. The new PID values then become 7.5, 1.2, and 1.4.

- The new values (P and I) will be used until the zone's temperature reaches the At Temperature window. The P and I values will then be restored to their original values.
- This feature only applies to zones that are using ART PIDs.
- The Fast Heating Enable setting is saved to the mold setup. The default value is selected.

9.6 Soft Start

During the soft start operation, all of the Altanium zones increase in temperature at the same time and at the same rate. The soft start operation causes an even thermal expansion and identical residence time on the material.

NOTE: Soft start is not in operation during the staged startup.

When the Start button is touched and the system starts, the Altanium does the operations that follow:

1. The Bake Out starts, if necessary.
2. If the ART process has not been done, it will start.

NOTE: The ART Process screen will show at the Soft Start.

3. "Soft Start" shows in the system status field. The power applied to the heaters is different from the probes to the manifold zones. The probes receive less power and the manifolds receive more. All of the zones increase in temperature at the same rate to make sure there is an even thermal transfer in the mold. This helps to prevent mold leakage.
4. When all temperatures are near their setpoint, "Running" is shown in the system status field.

9.6.1 Enable Soft Start

When soft start is enabled, it is applied the next time the mold heaters are ON.

To enable soft start, do the steps that follow:

1. On the Home screen, touch the **System Setup** button.
2. On the System Setup screen, touch the **Heats Setup** tab and then the **Control Page 1** tab.
3. On the Soft Start panel of the screen, touch the **Soft Start Enable** checkbox, so the check mark shows.

9.6.2 Disable Soft Start

When soft start is disabled, it will not be applied until the next time the mold heaters are ON.

To disable soft start, do the following:

1. On the Home screen, touch the **System Setup** button.
2. On the System Setup screen, touch the **Heats Setup** tab and then the **Control Page 1** tab.
3. On the Soft Start panel of the screen, touch the **Soft Start Enable** checkbox, so the check mark does not show.

9.6.3 Adjust the Soft Start Minimum Limit

The Soft Start limit is used to calculate the window between the lowest temperature zone and the highest temperature zone in the system. This window is used during the Soft Start process and controls the gap between the coldest and hottest zones. Usually, a lower Soft Start Limit value decreases the gap, which gives better thermal uniformity of the hot runner system from a cold startup.

To adjust the Soft Start Minimum Limit, do the steps that follow:

1. On the Home screen, touch the **System Setup** button.
2. On the System Setup screen, touch the **Heats Setup** tab and then the **Control Page 1** tab.
3. On the Soft Start panel of the screen, touch the **Soft Start Minimum Limit** field.
4. Enter the Soft Start Minimum Limit temperature value.

9.7 Alarms Screen

The Alarms screen shows the system errors that occur. Refer to [Figure 9-1](#).

When an alarm is active, an icon in the Alarms button (at the bottom of the Altanium screen) changes to yellow and flashes red. Touch the **Alarms** button to open the Alarms screen.

NOTE: For a description of the alarm conditions shown on the Event History screen and Alarm screen, refer to [Section 9.10](#). For a description of the abort conditions shown on the Event History screen and Alarm screen, refer to [Section 9.11](#).

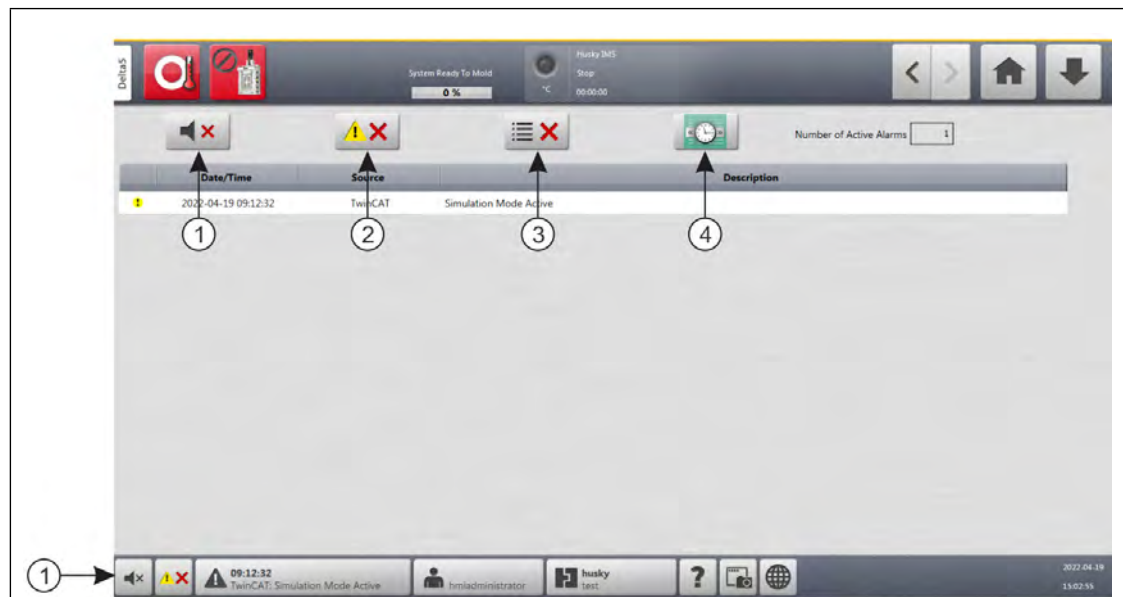


Figure 9-1 Alarms Screen

1. Silence Horn Button
2. Reset Alarms Button
3. Clear Inactive Alarms Button
4. Event History Button

The Alarms screen buttons are described in [Table 9-2](#). The Alarms screen information columns are described in [Table 9-3](#).

Table 9-2 Alarms Screen Buttons

Button	Description
Silence Horn	Stops the alarm tone.
Reset Alarms	Resets the alarm light and error message.
Clear Inactive Alarms	Clears the inactive alarms.
Event History	Touch this button to see the Event History screen.

Table 9-3 Alarms Screen Column Items

Item	Description
Number of Active Alarms	Shows the current number of active alarms.
Date/Time	Date and time that the alarm was triggered.
Source	Cause of the alarm.
Description	Description of the problem that triggered the alarm.

9.7.1 Open the Alarms Screen

To open the Alarms screen, do one of the tasks that follow:

- On the Home screen, touch the **Alarms** button.
- In the system footer, touch the **Alarms Information** button.

9.7.2 Alarm States

Alarm states are described in [Table 9-4](#).

Table 9-4 Alarm States

Alarm State	Description
Active	When an alarm first occurs, it is assigned the active state.
Inactive Not Acknowledged	Press the Reset Alarms button and the alarms will be assigned the inactive not acknowledged state.
Inactive Acknowledged	Press the Clear Inactive Alarms button and the alarms will be assigned the inactive acknowledged state.

9.7.3 Clear Alarms

If an error occurs, the Altanium starts an audible and visual alarm, and shows the alarm condition on the Alarms screen.

To clear an alarm, do what follows:

NOTE: Before resetting an alarm, correct the source of the alarm.

- To silence an audible alarm, touch the **Silence Horn** button.
- To reset the alarm light and acknowledge the alarm, touch the **Reset Alarms** button.

9.8 Event History Screen

The Event History screen lists the zone alarms, alarms, warnings, setpoint changes, setup changes, Human Machine Interface (HMI) startup, and out of specification events that have occurred. Refer to [Figure 9-2](#).

To view the Event History screen, touch **Event History** button from the Home screen.

NOTE: For a description of the alarm conditions displayed on the Event History screen and Alarm Summary screen, refer to [Section 9.10](#). For a description of the abort conditions displayed on the Event History screen and Alarm Summary screen, refer to [Section 9.11](#).

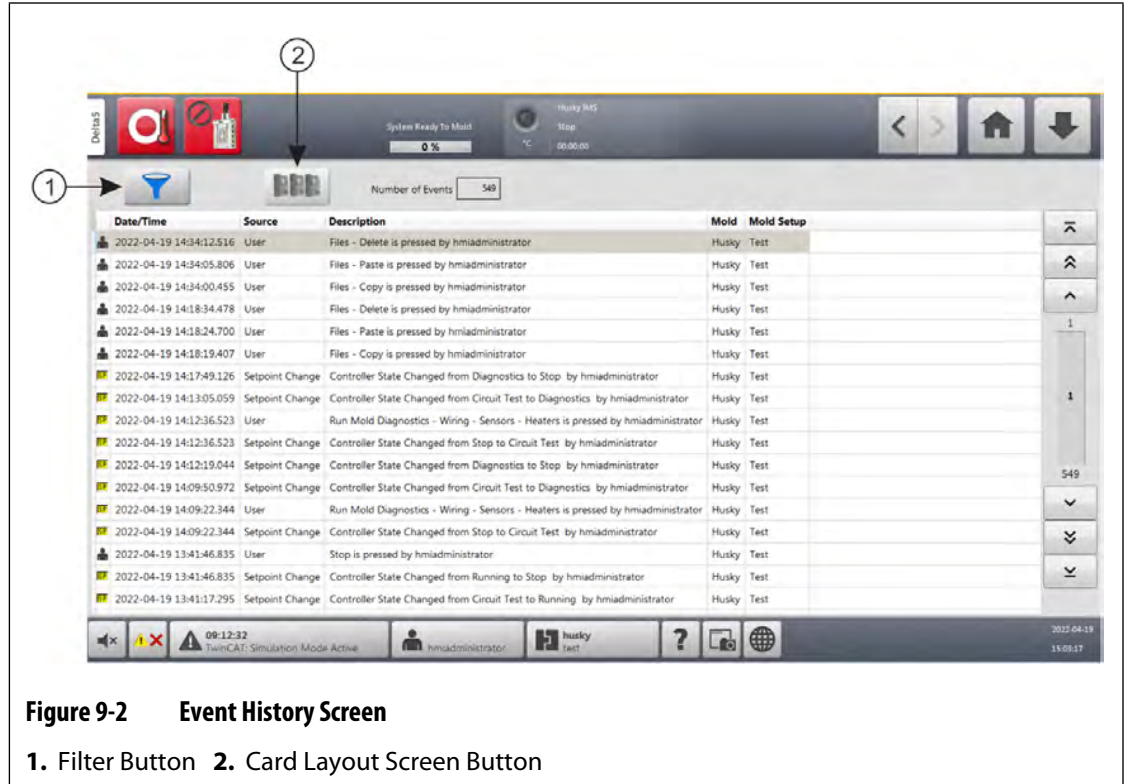


Figure 9-2 Event History Screen

1. Filter Button 2. Card Layout Screen Button

The information on the Event History screen is described in [Table 9-5](#).

Table 9-5 Event History Screen Information

Item	Description
Filter	Lets you select the type of events shown on the Event History screen. The event types include: <ul style="list-style-type: none"> • Zone Alarms (active and inactive) • Alarms (active and inactive) • Warnings (active and inactive) • Setpoint Changes • Setup (changes) • HMI Startup • Out of Specification (events)
Number of Events	This number shows how many events are listed on the Event History screen.
Date/Time	The date and time that the event was triggered.
Source	The cause of the event.
Description	The description of the event.
Mold	Shows the mold that is related with the mold setup that was loaded when the event occurred.
Mold Setup	Shows the mold setup that was loaded when the event occurred.

9.8.1 Filter Events

You can select the types of events you want to see from the Event History Filter window. Refer to [Figure 9-3](#).

To filter events, do the steps that follow:

1. On the Event History screen, touch the **Filter** button.



2. Select the filter type(s) you want to see on the Event History - Filter dialog window.

NOTE: Event types with check marks will be shown on the Event History screen.

3. Touch the **Exit** button.

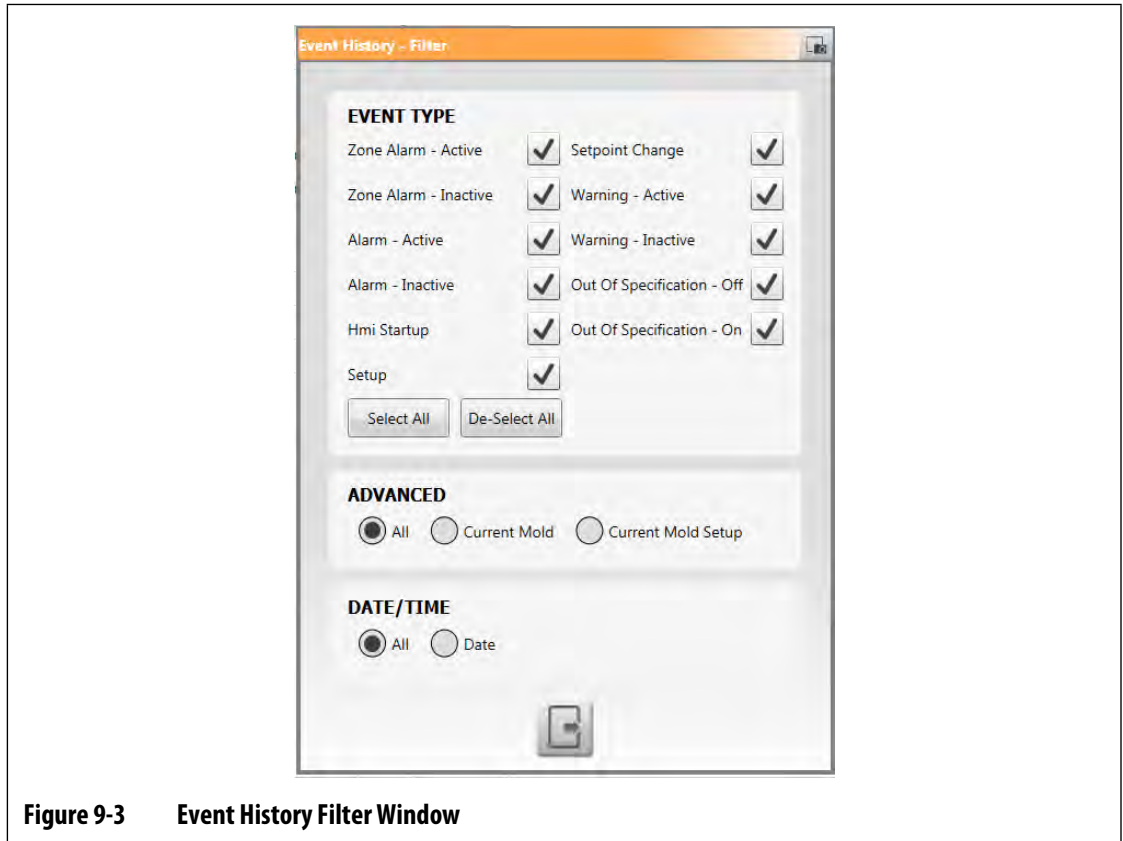


Figure 9-3 Event History Filter Window

9.9 Alarm and Event Icons

Table 9-6 identifies the icons that show on the Alarms and the Event History screens.

Table 9-6 Icons







Icon	Description
	The warning is inactive.
	The warning is active.
	The alarm or zone alarm is active.

Table 9-6 Icons (Continued)

Icon	Description
	The alarm or zone alarm is inactive.
	A user did an operation (pressed Start, pressed Stop, copied a file, pasted a file, deleted a file, and so on).
	A setpoint change was made. NOTE: This icon shows on the Event History screen, not on the Alarms screen.

9.10 Alarm Conditions — Warning Errors

Alarm conditions are shown on the Alarms and the Event History screens. The conditions listed in [Table 9-7](#) cause audible and visual alarms. Because they are warnings, they will not shutdown the system.

Table 9-7 Warning Errors

Warning	Description
Alarm Over Temp	A zone's actual temperature is more than its setpoint by the degrees set in the Alarm Window field on the Quick Set screen.
Alarm Under Temp	A zone's actual temperature is less than its setpoint by the degrees set in the Alarm Window field on the Quick Set screen.
Auto Following Enabled	A zone's thermocouple has become defective as the system operates in automatic control mode. The system has automatically assigned this zone to a different zone (leader zone) with the use of data it collected before the thermocouple became defective. The zone with the defective thermocouple becomes controlled by the power output from a similar zone. The leader zone number is shown in the Assign Leader Zone field of the defective zone on the Quick Set screen.

Table 9-7 Warning Errors (Continued)

Warning	Description
AMC Active	A zone’s thermocouple has become defective as the system operates in automatic control mode. There was no match found for this zone in the mold by the auto-follow feature or the auto-follow feature is OFF. The zone has been set to go into Automatic Manual Control (AMC) in this event. The zone is now controlled in manual mode at a power percentage selected by the controller with the use of data it collected before the thermocouple became defective.
Power Deviation	The zone’s power output value has deviated by an amount calculated by the power deviation algorithm. The power deviation algorithm uses calculation factors, which include a historical power average, heater type, changes to the power supplied to the unit, and other values.

9.11 Abort Conditions — Shutdown Errors

Abort conditions are shown on the Alarms screen and the Event History screen. The conditions listed in [Table 9-8](#) cause audible and visual alarms. Because they are shutdown errors, they will cause a zone or system shutdown condition controlled by the PCM settings.

Table 9-8 Shutdown Errors

Shut Down Error	Description
Abort Over Temp	A zone’s actual temperature is more than its setpoint by the degrees set in the Abort Window field on the Quick Set screen.
Abort Under Temp	A zone’s actual temperature is less than its setpoint by the degrees set in the Abort Window field on the Quick Set screen.
Circuit Overload	The current on this zone has increased above the maximum value for current deviation.
Configuration	Each zone’s control parameters are compared to the values sent and received by each zone. If the values are different, the system automatically corrects the problem. If the problem is not corrected after one minute, the configuration alarm is triggered.
Control Card Over Temperature	A control card temperature is more than 76 °C (170 °F).
Fuse 1 Blown	Fuse 1 on this Intelligent Control Card (ICC ² or ICC ³) has opened and must be replaced.
Fuse 2 Blown	Fuse 2 on this Intelligent Control Card (ICC ² or ICC ³) has opened and must be replaced.

Table 9-8 Shutdown Errors (Continued)

Shut Down Error	Description
Earth Leakage Limit	ICC ² : If the earth leakage is more than the calculated limit or default value, the earth leakage error is triggered.
	ICC ³ : If the measured leakage level is more than the Earth Leakage Fault Limit value, the earth leakage error is triggered.
Lost Thermocouple	This zone has a defective or open thermocouple.
Maximum Temp Limit	The temperature on this zone has increased above the maximum value permitted. The usual cause for this is that the switching device has failed in the closed position and the zone heater continued to apply heat. The factory setting is 95 °C (200 °F) over the normal setpoint.
No Response	The Altanium has applied 96% to 100% power to this heater for a set amount of time, and the thermocouple connected to this zone does not show an indication. The thermocouple is possibly damaged, or the heater power wires are broken.
Over Current Limit	The current on this zone has increased above the maximum value permitted.
Receive Data Comm	The data that the zone receives from the Altanium controller has stopped.
Rev. Thermocouple	The positive and negative leads from the thermocouple have been switched or the connections are reversed. As power is applied, the temperature decreases when it should increase. Correct this problem at the location where the wires are reversed.
Read Time Out	The data that is transmitted from the zone to the Altanium controller has stopped.

Chapter 10 System Setup

This chapter contains the information necessary to setup the Altanium controller for operation. Many of the configurations are set in the System Setup screen, which are in tabbed groups. Other configurations are found in their own screens, selected from the Home screen. This chapter starts with an introduction to the System Setup screen with descriptions of the configuration items in the tabs of the screen. The other sections in the chapter describe the most used system-wide configurations for the Altanium controller and the steps to complete them.

Users must be given access by approved persons to change items on the System Setup screen. This is done with assigned user roles from the User Management and Screen Security tabs. Refer to [Chapter 5](#).

The configuration settings are grouped by their applicable function to make them easier to find and set. The groups (or categories) are shown as six labeled tabs at the bottom of the System Setup screen. The tabs are:

- Main 1 & Main 2
- User Management (refer to [Chapter 5](#))
- Screen Security (refer to [Chapter 5](#))
- Network
- Heats Setup

Touch a tab to see and configure the setups for that group.

The subsections that follow describe the setup items found on each tab of the System Setup screen.

NOTE: Your System Setup screens could look different from what is shown in the sections that follow.

NOTE: The User Management and Screen Security tabs are described in [Chapter 5](#).

10.1 System Setup - Main 1 and Main 2 Settings

Touch the **System Setup** button on the Home screen to see the System Setup screen.

Touch the **Main 1** tab at the bottom of the System Setup screen to see the setup and informational items. Refer to [Figure 10-1](#).



Figure 10-1 System Setup - Main 1 Screen

The setup and informational items on the Main 1 screen are described in [Table 10-1](#).

Table 10-1 System Setup - Main 1 Screen Items Descriptions

Item	Description
Serial Number	The serial number is for information only. It is a number given to the system when it is manufactured. Husky support may ask for this number when they need to troubleshoot or upgrade the Altanium.
Model	The controller model name.
Software Version	The software version that is loaded onto the Altanium. This is for information only. Husky support may ask for this number when they need to troubleshoot or upgrade the Altanium.
Software Configuration	This identifies the configuration of the software for your Altanium controller and is shown for information only.
Disk Image Version	The disk image used to load the software onto the Altanium. This is for information only. Husky support may ask for this number when they need to troubleshoot or upgrade the Altanium.
Company Name	The company name displayed on the status bar.
Drive Firmware Version	Touch this button to see a list of the firmware versions installed for the servo axes on the system. The IP addresses for the axes are also shown.

Table 10-1 System Setup - Main 1 Screen Items Descriptions (Continued)

Item	Description	
User Settings	Touch the Configure button to set the items that follow:	
	Language	The language used on the Altanium user interface.
	Force Temperature Units to	Forces the temperature units to specified setting.
	Units	Used to set the units of measure (SI or Imperial) shown on the Altanium user interface.
	Date and Time	The date and time shown on the Altanium user interface.
	Time Zone	The time zone shown on the Altanium user interface.
	Automatic Daylight Saving	Automatic daylight savings on/off checkbox.
Log Transfer	Transfer data log or event log in CSV format to a specified log file destination. The complete log is transferred, or a time range can be set.	
Diagnostics Export	Used to export diagnostics files to a USB drive. This is for Husky Technical Support use only. Contact Husky for help, if necessary.	
Air Filter	Used to set a reminder interval for the air filter replacement.	
License Number	The license key is shown.	
Update License	Used to upload new license file from Local, USB, and Network drives.	
View License	Shows the license information.	
Remote Load	This panel is used to select the mold setups that can be loaded directly from the injection molding machine. Identifies the loaded mold setup ID and indicates that the remote file has been loaded.	
Acknowledge Alarm	Used to set a signal (example: digital input) to acknowledge alarms, so the user does not have to press the alarm reset button.	
Forced I/O Warning Enable	When enabled, a “Channel Forced” warning is shown when a signal is forced. This option applies to all signals able to be forced. The warning source will be a signal group. The default setting is enabled.	

Touch the **Main 2** tab at the bottom of the System Setup screen to see the setup and informational items. Refer to [Figure 10-2](#).



Figure 10-2 System Setup - Main 2 Screen

The setup and informational items on the Main 2 screen are described in [Table 10-2](#).

Table 10-2 System Setup - Main 2 Screen Items Descriptions

Item	Description
Turn Off Display	Enables the function to turn off the display if it is not used in a set interval of time.
Turn Off Display After	Used to set the interval of time of nonuse that the controller waits before it turns off the display.

10.2 System Setup - Network Settings

You can configure the controller, so that it can communicate on a local network. Use this feature to transfer files between the controller and a network share, or to provide information over the network through a defined software interface (OPC, Modbus, and so on).

To get access to network selections, touch the **Network** tab on the System Setup screen. Refer to [Figure 10-3](#).

On the Network Setup screen, you can configure the controller for a wired or wireless (WiFi) network connection. A network path can be entered for the shared network folder to upload or download files to and from the controller, in the format \\server\shared folder.

For help with your controller, Husky can give assistance with a remote connection to your system with the Remote Service Assistance application.



Figure 10-3 Network Setup Screen

10.2.1 Wired Network

To change the network settings for a wired network, do the steps that follow:

1. On the System Setup screen, touch the **Network** tab.
2. Touch the **Setup** button in the WIRED NETWORK section of the screen.

The Wired Network Setup dialog shows. Refer to [Figure 10-4](#).

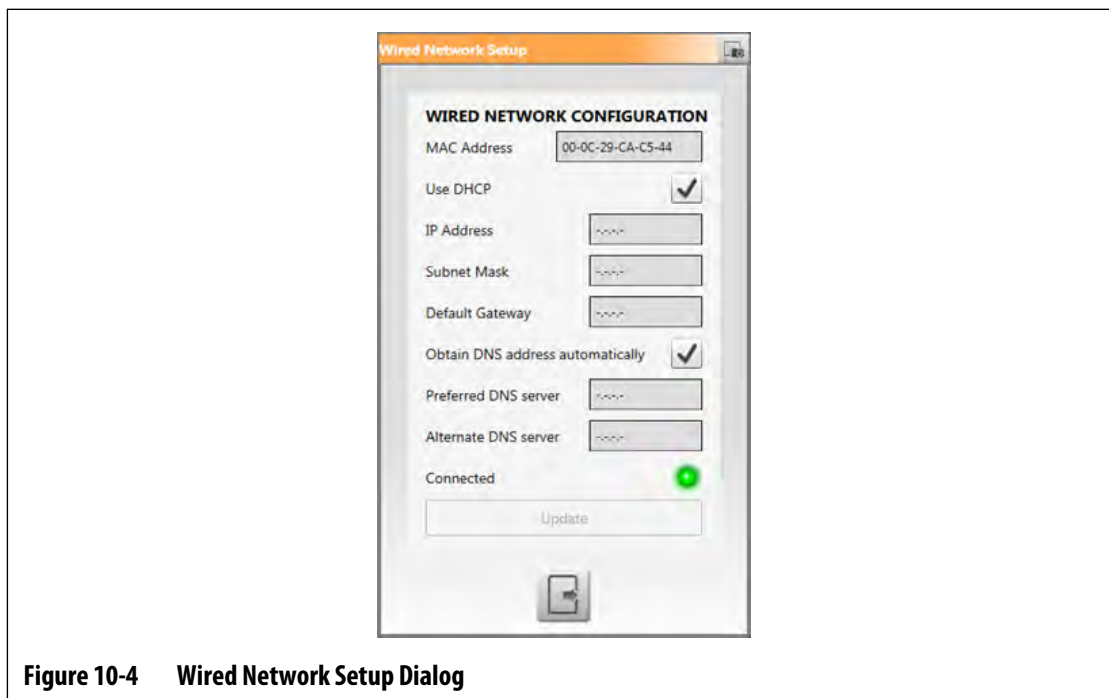


Figure 10-4 Wired Network Setup Dialog

3. Enter the necessary information in the fields to configure the network connection.
4. Touch the **Update** button.

The Connected indicator will show when the network connection has been made.

10.2.2 Wireless Network

To change the network settings for a wireless network, do the steps that follow:

NOTE: The controller does not have a built-in wireless adapter. To connect to a WiFi network, a D-Link DWA-182 or DWA-171 wireless adapter must be connected to the controller. Refer to [Figure 10-5](#).



Figure 10-5 D-Link DWA-182 or DWA-171 Wireless Adapters

1. Touch the **Setup** button in the WIRELESS NETWORK section of the screen. The Wireless Network Setup dialog shows. Refer to [Figure 10-6](#).

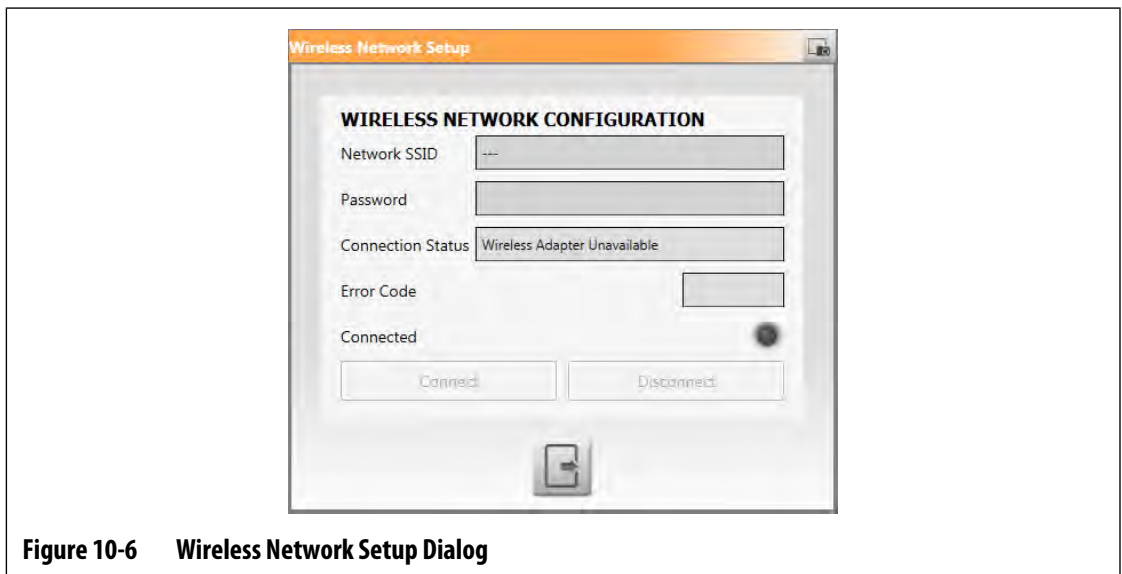


Figure 10-6 Wireless Network Setup Dialog

2. Connect a D-Link DWA-182 or DWA-171 wireless adapter to the USB port on the controller.

NOTE: After the D-Link wireless adapter is connected to the controller, it is automatically detected by the HMI software. The connection status changes to “Searching for Available Networks”. If there is one or more WiFi networks available in the area, the connection status changes to “Ready to Select Network” and enables the Network SSID.
3. Touch the **Network SSID** field and a list of all available WiFi networks will show.

NOTE: The SSID, Authentication method, and Signal strength for all available WiFi networks are shown. They listed in order by their signal strength.

4. Select an SSID from the list.

The SSID shows in the Network SSID field.

NOTE: The HMI application supports specific types of the authentication modes (Open, and WPA-Personal) for wireless network configuration. If an unsupported network is selected, the value of the Network SSID field does not change and the “Network security type is not supported” message shows (refer to [Figure 10-7](#)). If you selected a Network SSID that is not supported, a different one must be selected.

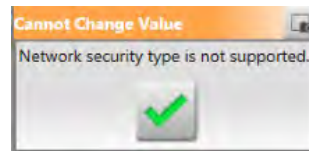


Figure 10-7 Unsupported Network Security Message

5. Enter the password for the Network SSID in the Password field.
6. Touch the **Connect** button.

The Connected indicator will show when the network connection has been made.

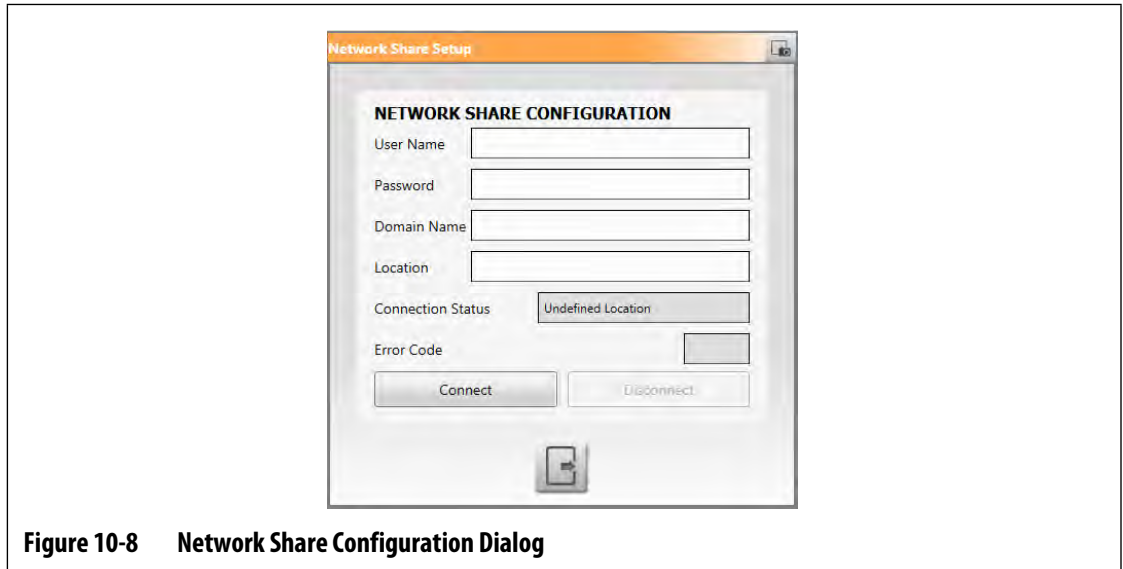
NOTE: If the password is not correct the Connections Status shows an “Unable to connect” message for a few seconds and then it changes back to “Ready to connect”.

10.2.3 Network Share

The Network tab on the System Setup screen lets you enter the information necessary to connect to a network shared storage folder (network share).

To get access to network selections, touch the **Setup** button on the Network Share panel of the screen.

The Network Share Configuration dialog shows. Refer to [Figure 10-8](#).



On the Network Share Configuration dialog, you can enter the network path for the shared network folder to upload or download files to and from the controller, in the format: **\\server\shared folder**.

Table 10-3 gives a description of the fields and buttons used to connect to a network share.

Table 10-3 Network Configurations

Item	Description
User Name	The user account name used to connect to a network share.
Password	The password used to connect to a network share.
Domain Name (Optional)	The name of the domain that the network share is on.
Location	The UNC path that specifies the server name and shared folder on a network. Example: \\companyserver\shared

Table 10-3 Network Configurations (Continued)

Item	Description	
Connection Status	A status field that notifies the user of the current state of the network share connection. Possible values are:	
	Not Connected	The system is not connected to the specified network share.
	Undefined Location	The Location field has no value specified.
	Connecting	The system does the operation to connect to the specified network share.
	Connected	The system has connected to the specified network share.
	Unable to Connect	The system could not connect to the specified network share. See the 'Error Code' field.
	Disconnecting	The system does the operation to disconnect from the specified network share.
	Unable to Disconnect	The system could not disconnect from the specified network share. Refer to the Error Code field.
	Network Unavailable	The connection to the network stops. This occurs if the network cable becomes unplugged or there is an issue with the network adapter.
Error Code	This field reports the error code returned by the Windows operating system when the controller tries to connect to, or disconnect from, a network share. This will be used to troubleshoot any problems that occur with the use the networking feature. There are approximately 16,000 documented error codes, so it is not possible to list and describe each one. Here are two examples as a reference:	
	85	The local device name is already in use.
	2250	The network connection does not exist.
Connect Button	Used to initiate a connection to the specified network share.	
Disconnect Button	Used to remove the current connection to the specified network share.	

10.2.4 Dashboard Interface

The Dashboard Interface panel of the Network screen lets you enable the interface and enter the IP address of the dashboard server. The dashboard connection status and disconnected status are also shown.

Touch the Setup button on the Dashboard Interface panel, and the Dashboard Interface Configuration dialog shows. Refer to [Figure 10-9](#).

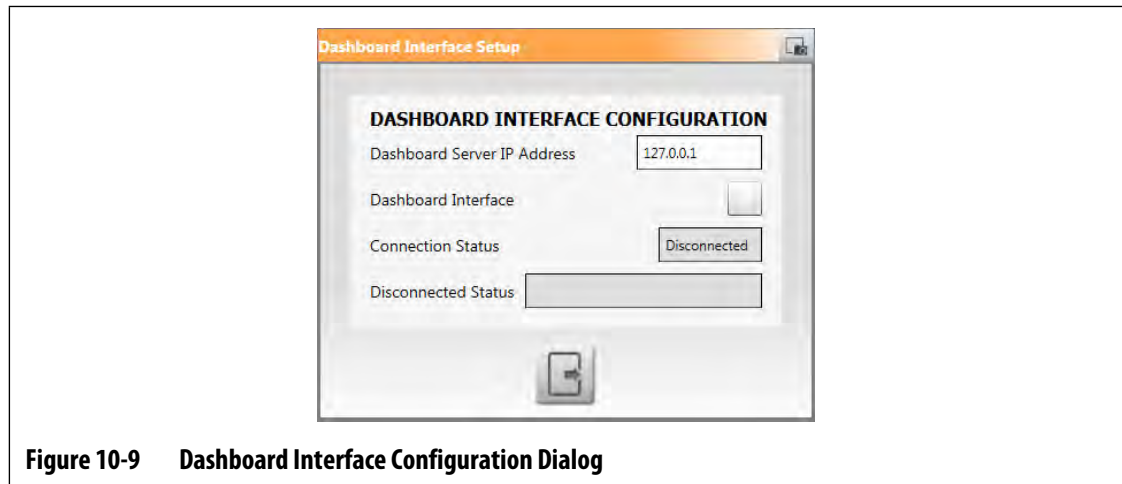


Figure 10-9 Dashboard Interface Configuration Dialog

With a numbered address entered in the Dashboard Server IP Address field, the connection is started when the Dashboard Interface checkbox is enabled.

10.2.5 Remote Service Assistance

If you find a problem that you cannot correct, contact the nearest Husky Regional Service and Sales office. Working with a Husky service technician, you can start a TeamViewer session that lets the technician see and operate your Delta5 controller system remotely.

The sections that follow describe how to enter proxy server information, if used, and how to start a TeamViewer session.

10.2.5.1 Proxy Settings

The Proxy Settings window is used to enter proxy server information and save the information in the database. This information can be used by Remote Service Assistance.

To enter the proxy settings, do the steps that follow:

1. From the Remote Service Panel, touch the **Proxy Settings** button to open the Proxy Settings window.
2. Touch the checkbox to use a proxy server.
A check mark will show in the checkbox if a proxy server will be used.
3. Enter the proxy server information in the fields that follow:
 - Address
 - Port
 - User Name
 - Password
 - Domain Name
4. Select the green check mark to accept the information you entered.

10.2.5.2 Start a TeamViewer Session

If problem cannot be corrected on the phone, the Husky service technician will give you a user name and password to start a TeamViewer session. TeamViewer lets the technician see and operate your Delta5 system remotely.

Do the steps that follow:

NOTE: A keyboard is necessary for some of these steps.

1. On the System Setup screen, touch the **Network** tab.
2. Touch the **Start Session** button in the Remote Service Assistance panel of the screen. Refer to [Figure 10-10](#).

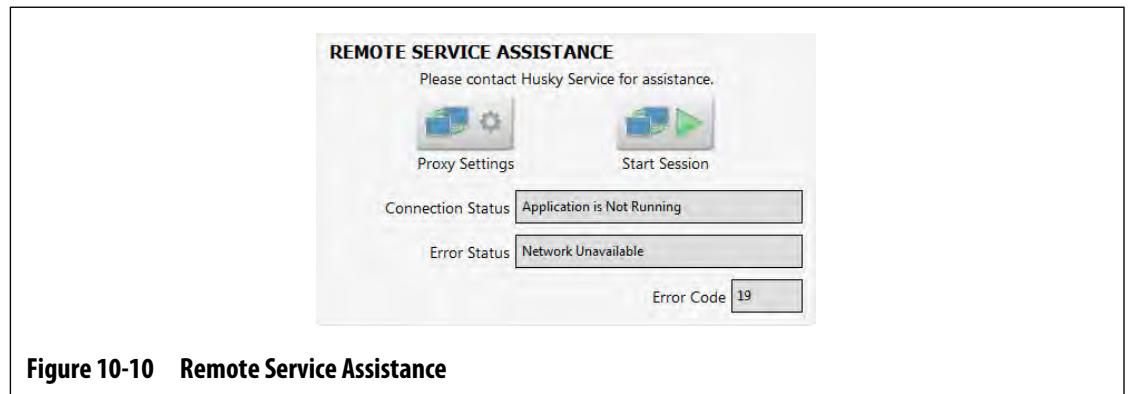


Figure 10-10 Remote Service Assistance

3. When the TeamViewer dialog shows, type the user name and password in the correct fields.
4. Touch the **OK** button.
If there are network connection requirements, a dialog box is shown.
A new icon is shown on the screen footer when TeamViewer starts.
5. Follow the instructions that the Husky representative gives you to complete the connection.

The Husky service technician starts a remote connection or desktop view application. You must give your approval for the remote connection when the dialog box is shown.

The Husky service technician can see and operate your Delta5 system screens. You will be directed to make changes, if necessary.

You can stop the remote session, or it will stop automatically when the technician stops the session. This causes the current user to be logged off. The user is also logged off if the session fails to connect. When the remote session is stopped, the icon/drop-down menu in the footer is removed.

10.2.6 Virtual Network Computing

With Virtual Network Computing (VNC), if installed, you see the Delta5 controller HMI on the Injection Molding Machine HMI. This lets you see data and make changes in one central location. You can relocate the Delta5 controller to a different location and to reduce the number of HMIs in the molding cell to a single screen.

With the VNC feature installed on your Delta5 system, a VNC Server Options panel will show on your Network screen. Refer to [Figure 10-11](#).

For VNC operation, VNC client software must be installed. The controller and the IMM must be on the same network with no firewall between them.

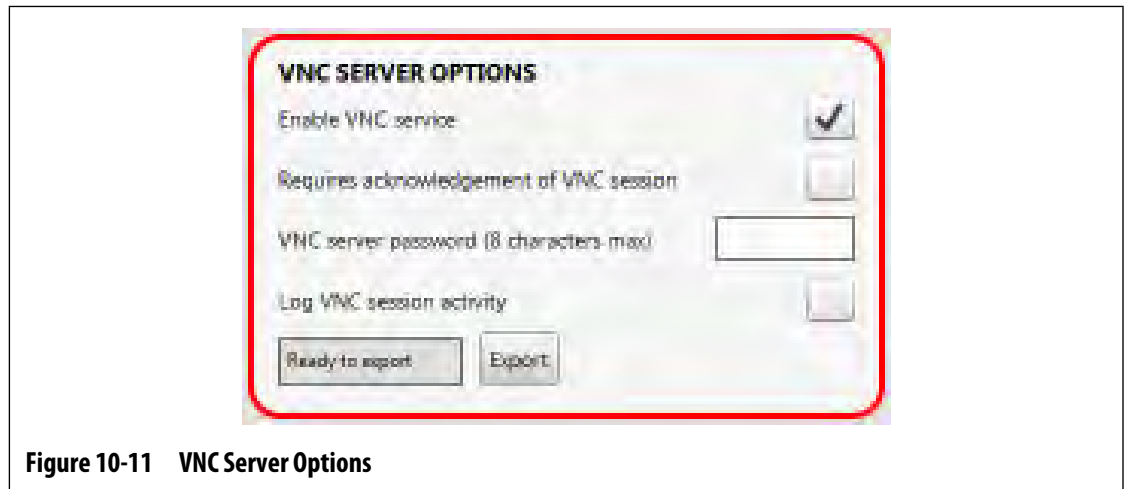


Figure 10-11 VNC Server Options

[Table 10-4](#) describes the VNC Server Options.

Table 10-4 VNC Server Option Descriptions

Item	Description
Enable VNC service	Use this checkbox to enable the VNC service.
Requires acknowledgement of VNC session	Use this checkbox to enable the security challenge that is shown on the server when a client tries to connect.
VNC server password (8 characters maximum)	<p>Use this field to set a password that must be given by the client before a VNC session/connection can occur.</p> <p>NOTE: If the password is changed using the VNC client, the client will disconnect without warning when the service stops. After a period of about 15 seconds (which lets the service to restart and stabilize), the client can reconnect to the server with the use of the new password.</p> <p>The password length must be between three and eight alphanumeric characters.</p> <p>NOTE: The password length is a limitation of VNC and not of the operating system.</p>

Table 10-4 VNC Server Option Descriptions (Continued)

Item	Description
Log VNC session activity	<p>Use this checkbox to enable VNC logging. Logging information is written to a text file and can be retrieved with the Log File Export Option.</p> <p>NOTE: At intervals, the VNC log is deleted, so the file does not use too much disk space. If the log file is found to be over 1 MB in size, the file is deleted. This check is performed on every system start up. If the log is deleted, an entry will be made to the alarm system.</p>
Export	<p>Use this button to export the most recent VNC log file (and other log files) to an external drive. This feature operates the same as the log export found on the Main tab of the System screen.</p>

10.2.6.1 VNC Client

The VNC client is the IMM that connects to, views, and/or controls a VNC server (Altanium Controller). The client computer requires the installation of a VNC client viewer (for example, Real VNC).

NOTE: A VNC client should be able to connect to any computer running VNC server software, regardless of the manufacturer.

10.2.6.2 VNC Server

The VNC server is the Altanium Controller that is controlled by a VNC client. VNC server software is already installed on your controller.

10.2.6.3 VNC Connection

Most VNC client software applications can be used to connect to the HMI machine (VNC server). The instructions below are specifically for vncviewer.exe. However, these steps should apply to most VNC client software applications.

NOTE: Problems on the VNC client, such as blank/black screens, irregular or slow screen rendering, and other UI related problems, are a possible fault of the setting(s) on the VNC client, not the server. When in question (or when no instructions are available), always select an “auto configuration” option (if the VNC client software supports it). The client will negotiate with the server to determine the set of compatible capabilities.

For security purposes, VNC makes it necessary for a password to be used for server installation. A new password can be created by an operator with the correct screen permissions. Passwords can be an alphanumeric combination with a length between three and eight characters.

If the “Requires acknowledgement of VNC session” option is enabled, a connection cannot be made by a client until it is approved by the operator of the VNC server. When the client attempts to connect to a VNC server, a dialog will show that asks the operator to Accept or Reject the connection. If no action is taken on the server operator’s part, the request will

timeout in 30 seconds. The session will be closed on the client. If the connection is accepted, the client will be able to view and operate the VNC server.

For connectivity or application problems, the VNC server can optionally write its activities to a log file. The VNC server must be configured to log its activities. An operator uses the Export button at the bottom of the VNC Server Options panel to get a copy of the VNC log. You can also use the Export button in the Diagnostic Export panel on the Main tab of the System Setup screen.

To set the VNC configuration for logging, do the steps that follow:

1. On the Network tab of the System Setup, make sure the **Enable VNC service** option is enabled (check mark in the checkbox).
2. Make sure the **Log VNC session activity** option is enabled (check mark in the checkbox).

All VNC activity will be recorded to a log file.

To download the VNC log file, do the steps that follow:

1. On the Network tab of the System Setup, disable the **Log VNC session activity** option (click to remove the check mark from the checkbox).
2. Insert a USB drive into any available USB port.
NOTE: The USB drive should have at least 5GB of free space. Log files from other sub-systems are exported during this process.
3. Click the **Export** button at the bottom of the VNC Server Options panel.
NOTE: The Export button in the Diagnostic Export panel on the Main tab of the System Setup screen can also be used.
4. Navigate to the location on the USB drive where you want the VNC log file saved.
5. Click the green check mark button.

The VNC log file will be written to the selected location and will have the name: WinVNC.log.

If the VNC log file is unavailable when an export is started, there are two events that could cause this:

- The log file was deleted immediately before the export was started.
- The “Log VNC session activity” option was not enabled during VNC activity.

If the VNC log file is not available when a download is done, a placeholder file will be created with the same name (WinVNC.log) as the standard log. The contents of this placeholder file will give the possible causes for the absence of the VNC session information.

10.2.7 OPC UA Interface

Husky gives you the option of using the industry standardized Open Platform Communications – Unified Architecture (OPC UA) for safe, secure, and dependable data exchange between machine to machine on the factory floor and/or machine to cloud in an enterprise. The Husky OPC UA server supports the Euromap 82.2 standard for hot runner devices. OPC UA relies on digital certificates to provide secure communication between a client and a server so that the data is confidential and cannot be modified during transmission.

Two Euromap 82.2 versions are available:

- EM82.2 OPCUA Interface RC19 (Euromap RC 1.00.3)
- EM82.2 OPCUA Interface R 1.00 (Euromap R 1.00)

NOTE: For information or assistance on the OPC UA server and/or interface setup, contact Husky.

10.2.7.1 OPC UA Interface Enable

To see the OPC UA Interface Setup window:

1. On the System Setup screen, touch the **Network** tab at the bottom of the screen.
2. Touch the **Setup** button in the OPC UA Interface of the screen.
3. Use the OPC UA Interface Setup window to configure the communication settings.

The left side of the window lets you enable the OPC UA interface, see the connection status, shows if the interface is running, and export diagnostic information to a USB drive (refer to [Figure 10-12](#)).



Figure 10-12 OPC UA Certificates - Server

Table 10-5 gives the descriptions for the OPC UA interface items (left side of window).

Table 10-5 Interface Descriptions

Item	Description
Interface Enable	Enables or disables communication between the Altanium HRC and the OPC UA server.
Connection Status	A status that is displayed when the user enables the interface. Possible values are: <ul style="list-style-type: none"> • Disabled • Connecting • Connected • Disconnected.
Disconnected Status	Displays error descriptions of why the interface is disconnected.
Server Software Version	The current version of the OPC UA server.
Service is Running	A status LED indicator that lets the user know if the OPC UA server service is running.
Export	Diagnostic information that gets exported to a USB flash to aid in troubleshooting technical issues.

10.2.7.2 Certificates

The Altanium Delta5 controller includes functions for creating, importing, and exporting X.509 digital certificates for the purpose of fulfilling secure communication between the client and server. It also provides the ability to create, import and export user certificates to be used in user identity authentication.

The certificate management utility is shown on the right side of the OPC UA Interface window. Figure 10-12 shows the certificate selections if Server certificates are used. Figure 10-13 shows the certificate selections if Client or User Authentication certificates are used.

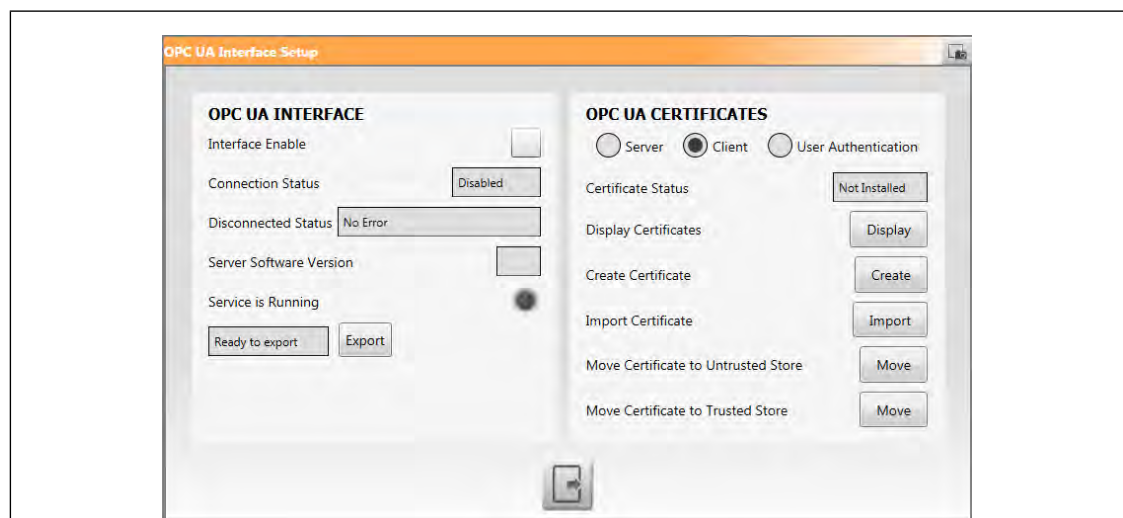


Figure 10-13 OPC UA Certificates - Client or User Authentication

Table 10-6 give the certificate Management utility descriptions (right side of window).

Table 10-6 Certificate Management Utility Descriptions

Item	Description
Certificate Type (radio buttons)	Choose the type of certificates to manage by selecting a specific radio button.
Certificate Status	The system will display the following statuses: 'Not Installed', 'Installed' or 'Expired'.
Display Certificates	Touch this button to see a dialog with all the user authentication certificates installed on the system.
Create Certificate	Touch this button to create a self-signed user authentication certificate and export it to a USB drive.
Import Certificate	Touch this button to see a dialog that lets you import a ".der" certificate into the 'Clients' store.
Move Certificate to Untrusted Store	Touch this button to see a dialog that lets you select a specific client certificate and move it to the 'Untrusted Certificates' store. This is normally done when a certificate's public or private key has been comprised and cannot be relied upon to provide secure communication.
Move Certificate to Trusted Store	Pressing this button will display dialog to allow the user to select a specific client certificate and move it to the 'Trusted' store. This is done when it is determined that the certificate can be trusted or it was moved by mistake.

The certificate validity periods are described as follows:

Server Certificates

- Certificate Key Size – 2048 bits.
- Certificate Validity Period – The server certificate validity period is 63 months (5 years, plus 3 months).
- Expiration Monitoring – The controller monitors all server certificates to see if they are close to expiring or are already expired. The extra 3 months of the validity period is used to warn you that the certificate will expire soon. An alarm will be shown on the HMI for you to acknowledge.

Client / User Authentication Certificates

- Certificate Key Size – 2048 bits.
- Certificate Validity Period – The server certificate validity period is 27 months (2 years, plus 3 months).
- Expiration Monitoring – The controller monitors all client and user authentication certificates to see if they are close to expiring or are already expired. The extra 3 months of the validity period is used to warn you that the certificate will be expire soon. An alarm will be shown on the HMI for you to acknowledge.

10.2.8 ShotscopeNX

If your system has the optional ShotscopeNX (SSNX) feature, the interface setup panel will show on the Network tab. SSNX models intelligent devices, so that the data from subsystems, such as hot runner controllers, can be joined together with data from the IMM to give an integrated view of a cell's data.

NOTE: The security permission must be set on the System Setup screen (System Setup -> Screen Security tab -> Main tab) to enable the SSNX.

To enable and set the SSNX Interface, do the steps that follow:

1. On the System Setup screen, touch the **Network** tab at the bottom of the screen.
2. Touch the **Server IP Address** field and enter the IP address.
3. Touch the **Accept** button.
4. Touch the **Enable** checkbox, so the check mark shows.

The Connection Status field tells the user of the current status as the system tries to connect to the dashboard interface. This field is informational only and cannot be changed. The initial value shows Invalid until the interface is enabled for the first time. The possible values are:

- Disabled
- Connecting
- Connected
- Disconnected

The Disconnected Status field tells the user of the current status as the system tries to disconnect from the SSNX interface. This field is informational only and cannot be changed. The initial value shows Invalid until the interface is enabled for the first time. The possible values are:

- Empty (No problems)
- Shotscope NX Server Not Found
- Connection to Server Timeout Fault (Disable interface while connected)
- Shotscope NX Server Application Fault (Re-enable network interface)

10.2.9 Network Diagnostics

The Network Diagnostics panel of the screen is used to do a check of the network connectivity. When enabled, a permission rule is added to the firewall software that lets computers on the network ping the controller.

To do a check of the connectivity between the controller and a network computer, do the steps that follow:

1. On the System Setup screen, touch the **Network** tab at the bottom of the screen.
2. Touch the **Setup** button in the Wired Network Setup panel of the screen.
3. Record the IP address shown in the Wired Network Setup window and then exit the window.
4. Touch the **Ping Request Enable** checkbox and then touch the green check mark button to accept the change.
5. Go to the network computer and open a command prompt window.

6. Type in "ping <the IP address recorded in [step 3](#)>" and press Enter.
7. Make sure that four replies from the controller are shown on the command prompt widow (refer to [Figure 10-14](#)).

NOTE: If "Request timed out" is shown for the replies, then there is a network problem.

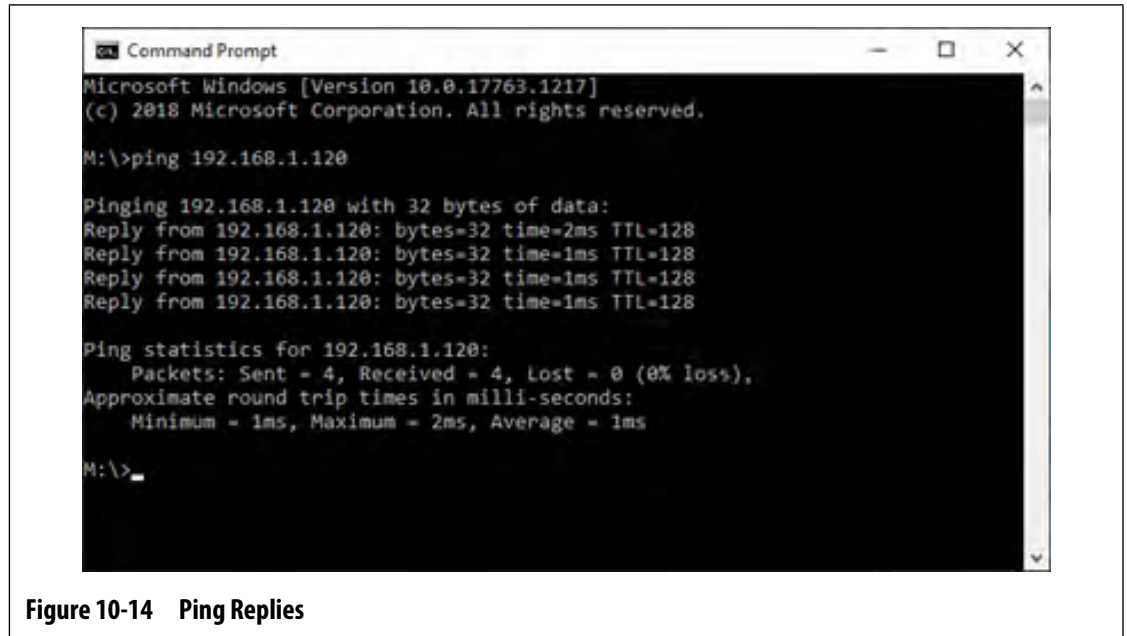


Figure 10-14 Ping Replies

10.2.10 Time Synchronization

NOTE: The time synchronization feature is not available on controllers with motion controls: Altanium Servo Control, UltraSync-E, Individual Servo Valve Gate, Valve Gate Sequencer, or UltraShot.

The Time Synchronization feature lets you connect the Delta5 controller to a time sever on a network. A connection to a time server is critical to minimize time errors during data collection and to make sure the date and time stamps for each sample are as close to true time as possible.

A time server is a type of network server, which transmits precise time information to its network clients by using a definite protocol, most commonly the Network Time Protocol (NTP). The time server needs a reference clock that defines the true time. For a reference, the server uses the Coordinated Universal Time (UTC) without offset. The UTC is the primary time standard by which the world regulates clocks and time. Client servers receive the UTC time without offset from the NTP.

The Delta5 controller receives the time from a time server that you specify, and automatically adjusts the time, based on the local time zone setting in the System Setup screen.

To configure the Time Synchronization, do the steps that follow:

1. On the System Setup screen, touch the **Network** tab at the bottom of the screen.
2. Touch the **Setup** button in the Time Synchronization panel of the screen.

The Time Synchronization Setup dialog window shows (refer to [Figure 10-15](#)).

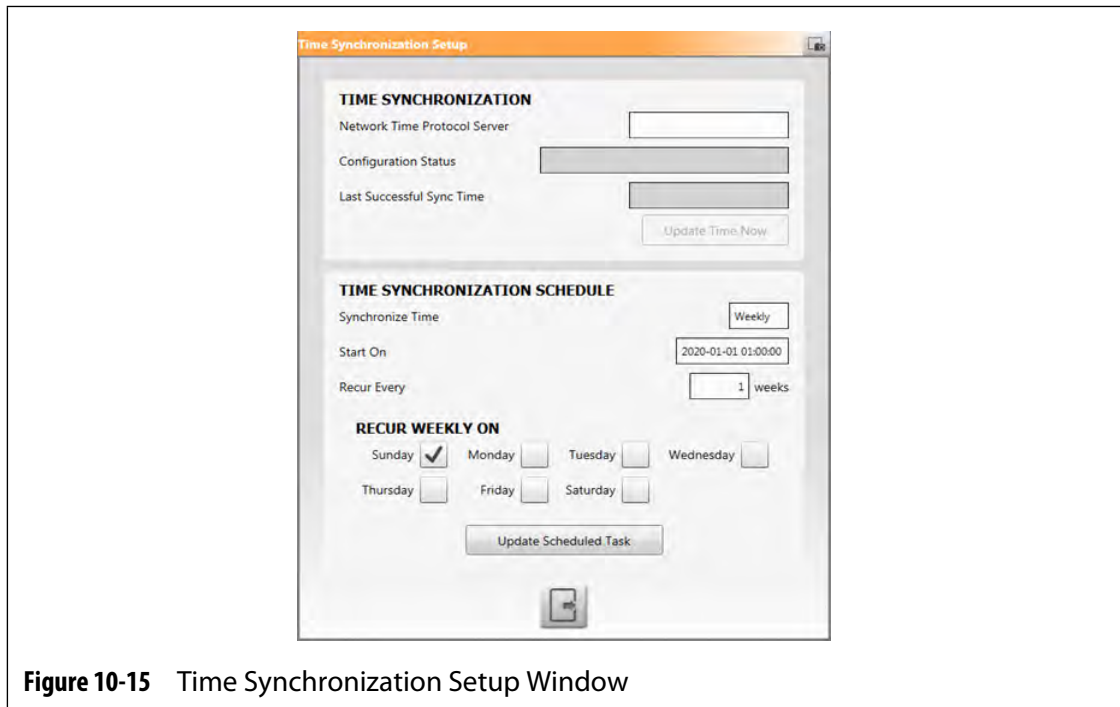


Figure 10-15 Time Synchronization Setup Window

3. Enter the necessary information in the fields described in [Table 10-7](#) to configure the Time Synchronization.

Table 10-7 Time Synchronization Setup Items

Item	Description
Network Time Protocol Server	<p>This is either the domain name or IP address of the time server you want to use to synchronize the time. Windows comes with a default list of time servers that can be used as well:</p> <ul style="list-style-type: none"> • time.windows.com • time.nist.gov • time-nw.nist.gov • time-a.nist.gov • time-b.nist.gov
Configuration Status	<p>A status field that lets you know if a failure occurs. It also provides some helpful information when trying to configure the NTP server or the scheduled task. The possible values are:</p> <ul style="list-style-type: none"> • Error changing time service startup type • Error changing time service configuration • Time server has been removed • Attempting to sync the time • Successfully synced the time • Error syncing the time • Attempting to update scheduled task • Successfully updated scheduled task • Error updating scheduled task • Task start time and date must be in the future

Table 10-7 Time Synchronization Setup Items (Continued)

Item	Description
Last Successful Sync Time	A status field that lets you know the last time a successful sync occurred. This field is updated automatically whenever the Time Synchronization Setup dialog is shown or whenever you update the time manually.
Update Time Now	This button is used to immediately synchronize the time with the time server specified. It will become disabled if the Network Time Protocol Server field is empty.
Synchronize Time	This setting specifies how often to synchronize the time. Possible values are: One Time, Daily, Weekly, or Monthly. The default value is Weekly.
Start On	This setting specifies the time and date of when to start the synchronization.
Recur Every	This setting specifies how many days, weeks, or months synchronization should occur, based on the Synchronize Time setting. Example: If the Synchronize Time is set for "Daily", a value of 1 means time synchronization should occur every day. The default value is 1, and the range is 1 to 365. Example: If the Synchronize Time is set for "Weekly", a value of 1 means time synchronization should occur every week. The default value is 1, and the range is 1 to 52.
Recur Weekly On/Recur Every Month On	This section allows the user to specify which days during the week or which day of the month that the time synchronization should occur. For a Synchronize Time set as "Weekly", the default is Sunday. For a Synchronize Time set as "Monthly", the default is First Day.
Update Scheduled Task	Use this button to update the scheduled task configuration.

4. Touch the **Update Scheduled Task** button to set the scheduled configuration.

10.3 System Setup - Heats Settings

Use the Heats Setup to configure all of the temperature and monitor settings for the mold. To access the Heat Setup, touch the **System Setup** button on the Home screen and then touch the **Heats Setup** tab at the bottom of the screen.

The Heats Setup is divided into three groups of related configuration settings, accessed with the tabs at the bottom of the screen:

- Control Page 1
- Control Page 2
- Monitoring

The sections that follow describe the configuration settings found in each group.

10.3.1 Heats Setup - Control Page 1

On the Control Page 1 tab of the Heats Setup screen, temperature configurations are set for the categories that follow:

- Manual Standby and Boost
- Remote Standby
- Remote Boost
- Bake Out
- Resin Protection Timer
- Soft Start
- Mold Cooling Enable

The Control Page 1 tab is shown in [Figure 10-16](#) with the configuration settings for each category. The configuration settings are described in [Table 10-8](#).



Figure 10-16 Heats Setup - Control Page 1

Table 10-8 System Setup Screen - Heats Setup - Control Page 1

Item	Description
Manual Standby Duration Timer	The zone temperature decreases for a given time duration or until a set standby temperature is achieved.
Manual Boost Duration Timer	The zone temperature increases for a given time duration or until a set boost temperature is achieved.
Remote Standby Duration Timer	When an external signal has activated the remote standby mode, the system temperature decreases to the remote standby setpoint for the duration of the timer setting.
Remote Standby Delay Timer	When an external signal has activated the remote standby mode, the system waits for a set time interval (delay period) until it starts a decrease in temperature to the remote standby setpoint.

Table 10-8 System Setup Screen - Heats Setup - Control Page 1 (Continued)

Item	Description
Remote Standby Input Mode	<p>The standby setting is enabled by one of three settings: Trigger, On/Off, or a Direct signal.</p> <p>Trigger: Includes a delay timer and duration timer. If the D/I signal is not sensed, Standby or Boost mode continues until the duration timer elapses.</p> <p>On/Off: Includes a delay timer. If the D/I signal is not sensed, the controller returns to the running state.</p> <p>Direct: The system changes to Standby until the input signal is not active. If the input signal is active when the system is started it will immediately go into Standby mode. Includes a delay timer.</p>
Reset Delay Timer in Direct Mode	This setting lets the delay timer reset if the signal goes low and then goes high again while in Delay Standby mode.
Remote Boost Duration Timer	When an external signal has activated the remote boost mode, the system temperature increases to the remote boost setpoint for the duration of the timer setting.
Remote Boost Delay Timer	The system initiates the remote boost mode after a set period of time.
Remote Boost Input Mode	The boost setting is enabled by one of three settings: Trigger, On/Off, or a Direct signal.
Bake Out Enable	If this parameter is enabled, the system runs the bake out test and applies a low voltage to remove the moisture in a heater, if required.
Force Bake Out Enable	If this parameter is enabled, each zone in the system is baked out at startup.
Bake Out Alert Enable	<p>If this parameter is enabled, the system stops and generates an alarm for each zone with a bake-out condition that has not been cleared during the bake out cycle.</p> <p>If this parameter is disabled, the system exits the bake-out cycle and continues the startup sequence.</p>
Bake Out Limit	<p>The system uses this value to trigger a bake-out condition. During system startup, if a zone is more than this limit, the system starts the bake out mode.</p> <p>For ICC² cards, the parameter range is 0 to 5 amps. The default value is 0.2 amps.</p> <p>For ICC³ cards, the parameter range is 1 to 999 milliamps. The default value is 200 milliamps.</p>
Bake Out Power	<p>The system uses this value during the bake out process.</p> <p>The parameter range is 0 to 25%. The default value is 5%.</p>
Bake Out Time Per Cycle	The time interval of the bake out cycle. The parameter range is 1 to 30 minutes. The default value is 5 minutes.

Table 10-8 System Setup Screen - Heats Setup - Control Page 1 (Continued)

Item	Description
Number of Bake Out Cycles	The number of tries to bake out the moisture in a heater. The parameter range is 1 to 5. The default value is 1.
Bake Out Setpoint	The bake out temperature that the zones must get to during the bake out process. The default value is 100 °C (212 °F). This is shown only if ICC ³ cards are installed.
At Bake Out Temperature Window	During the bake out process, this parameter sets the temperature threshold that all zones must get to before the bake out cycle value starts counting down. The default value is 5 °C (9 °F). Displays only if ICC ³ cards are installed.
Heat to Bake Out Setpoint Timeout	Sets the period of time the zones are given to get to the bake out temperature setpoint. If the time period ends, a warning message shows the problem and what occurs when the warning message is acknowledged. Shows only if ICC ³ cards are installed.
Resin Degradation Limit	This is the temperature limit that is used to start the timer. The default value is 121 °C (250 °F).
Cycle Idle Time Limit	The time interval before the system does one of the reactions. The timer starts when one of the zone’s temperatures is at or above the Resin Degradation Limit and the controller is not cycling. The timer resets when one of those conditions is no longer TRUE. The minimum time is 1 minute, the maximum time is 90 minutes, and the default value is 30 minutes.
Elapsed Idle Time	The time period that has elapsed since the timer was started. This updates in 1-minute increments.
Cycle Idle Reaction	<p>The action that occurs if the Idle Time Limit ends. The possible actions are:</p> <ul style="list-style-type: none"> • No Reaction • Warning Notification • Put Heats in Standby • Turn Heats Off
Soft Start Enable	Toggle this parameter On or Off. If this parameter is On, the soft start process is applied upon startup.
Soft Start Minimum Limit	When the soft start process is started, the system calculates the difference between the zones with the highest and lowest temperatures. If this difference is less than this parameter value, then this parameter value is applied to the soft start process.
Mold Cooling Enable Limit	The threshold the system uses to determine when to start or stop the Mold Cooling Enable output.

10.3.2 Heats Setup - Control Page 2

On the Control Page 2 tab of the Heats Setup screen, configurations are set for the categories that follow:

- Part Counting
- SPI
- Thermocouples
- Auto Following
- Zone Slot Configuration

The Control Page 2 tab is shown in [Figure 10-17](#) with the configuration settings for each category. The configuration settings are described in [Table 10-9](#).



Figure 10-17 Heats Setup - Control Page 2

Table 10-9 System Setup Screen - Heats Setup - Control Page 2

Item	Description
Part Counting	Used to automatically count parts and to set a sack full limit.
SPI	If a device is attached to the SPI connector, this section lets you enable communication with the device and set the communication protocol.
Display Thermocouple Reading for Manual Zones	A global setting that controls if the controller view screens show the thermocouple readings for zones in manual mode.
Same Thermocouple Assignment Maximum Limit	Sets the maximum number that a user can assign for the Thermocouple Assignment value setting on the Quick Set screen.
Auto Following Enable	Enables or disables Auto Following function.

Table 10-9 System Setup Screen - Heats Setup - Control Page 2 (Continued)

Item	Description
Auto Following Power Limit	This value is the limit used by the Auto Following function to calculate if the average power output of a candidate zone is in the permitted deviation of the follower zone.
Grid Size	Used to change the mainframe layout on the Card Layout screen.
Group Offset	Used to configure the linked systems. The default group offset setting is 96 zones.

10.3.3 Heats Setup - Control Page 3

On the Control Page 3 tab of the Heats Setup screen, configurations are set for the categories that follow:

- Heat Sequencing
- Heat Uniformity
- Tuning

The Control Page 3 tab is shown in [Figure 10-18](#) with the configuration settings for each category. The configuration settings are described in [Table 10-10](#).

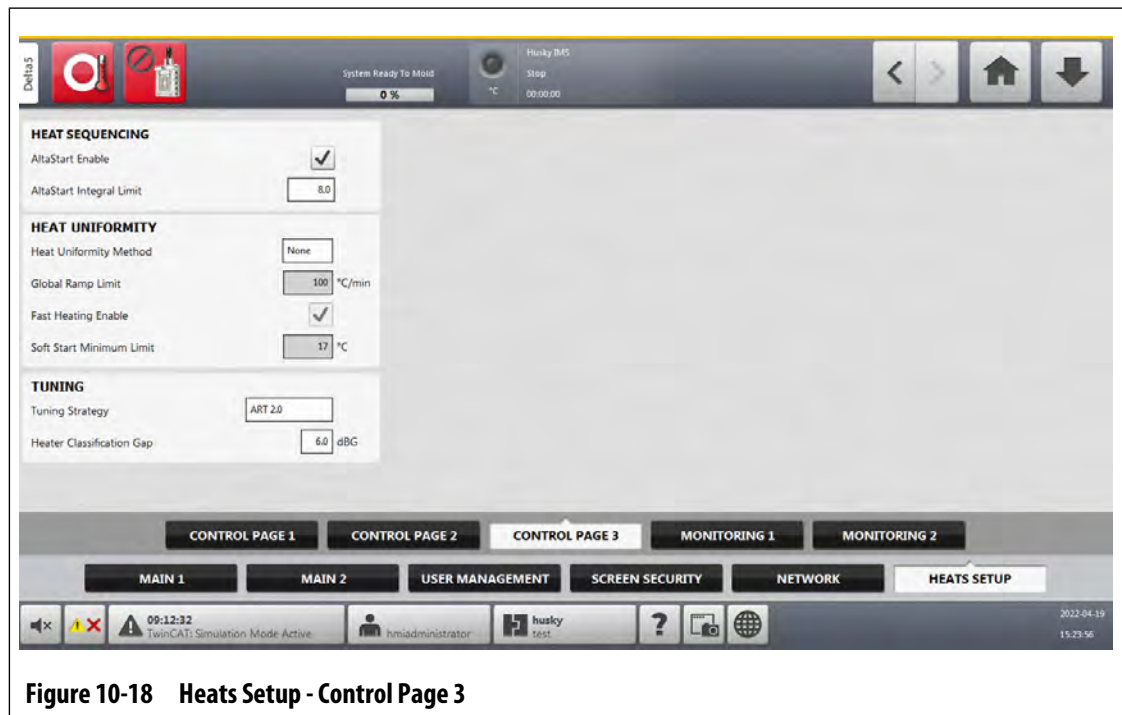


Figure 10-18 Heats Setup - Control Page 3

Table 10-10 System Setup Screen - Heats Setup - Control Page 3

Item	Description
AltaStart Enable	<p>Used to enable AltaStart function for heat sequencing. Refer to Section 9.3.</p> <p>NOTE: At least one zone's heater type must be set to 'Tips' or the system will not allow you to enable the function.</p>
AltaStart Integral Limit	<p>This setting is used when the system is using AltaStart to limit the integral value on tip zones if the value is greater than the limit. The limit will only be used until the zone's temperature reaches the 'At Temperature' window and then the integral's original value will be restored. The setting value is only used when the system is first started and after circuit test is complete. If the value is changed while running, then it will be ignored until the controller is stopped and then started again.</p> <p>The range is 0.1 to 250.0. The default value is 8.0.</p>
Heat Uniformity Method	<p>Lets you select the heat uniformity method you want to use:</p> <ul style="list-style-type: none"> • UniStart - When selected, this provides the shortest start-up time while ensuring that all temperatures track to their setpoint. Refer to Section 9.4. • Soft Start - When selected, the soft start process is applied upon startup. Refer to Section 9.6. • None <p>The default value is UniStart. Only the settings that are specific to the method selected will be enabled. For example, if UniStart is selected then all the Soft Start settings will be disabled. This setting is saved to the mold setup.</p>
Global Ramp Limit	<p>This setting is applied to all zones in the UniStart process. It is the rate at which temperature will increase per minute as it heats to setpoint. The valid range is 9°F to 180°F or 5°C to 100°C. The default value will be 180°F or 100°C. This setting is saved to the mold setup.</p>
Fast Heating Enable	<p>Used to enable the Fast Heating function (refer to Section 9.5).</p>
Soft Start Minimum Limit	<p>When the soft start process is started, the system calculates the difference between the zones with the highest and lowest temperatures. If this difference is less than this parameter value, then this parameter value is applied to the soft start process.</p> <p>NOTE: This setting is enabled only when Soft Start is selected in the Heat Uniformity Method field.</p>

Table 10-10 System Setup Screen - Heats Setup - Control Page 3 (Continued)

Item	Description
Tuning Strategy	Used to select the ART Classic or ART 2.0 tuning strategy. ART 2.0 is selected by default. Refer to Section 7.9 for information on the ART process.
Heater Classification Gap	Used to specify the gap that is used to determine where tip zones end and where manifold zones begin. The range is 1 to 9.9 dBG and the default value is 6 dBG. Refer to Section 7.9.2 for information on this setting.

10.3.4 Heats Setup - Monitoring 1 and Monitoring 2

On the Monitoring 1 tab of the Heats Setup screen, mold monitoring configurations are set for the categories that follow:

- Zone Alarm Control
- Monitor Zone Settings
- Voltage Settings
- Power Limiting
- Earth Leakage
- Circuit Test
- At Temperature
- Power Deviation

The Monitoring 1 tab is shown in [Figure 10-19](#) with the configuration settings for each category. The configuration settings are described in [Table 10-11](#).



Figure 10-19 Heats Setup - Monitoring 1

Table 10-11 System Setup Screen - Heats Setup - Monitoring 1

Item	Description
Alarm Sensitivity	The duration of time the system has to stay in an error condition before an alarm occurs.
Maximum Temperature Limit	The number of degrees over the setpoint that the Maximum Temperature Alarm occurs.
No Response Limit	A global setting that calculates how long the system should apply 96% power or greater without a 5 degree increase in temperature before an alarm occurs.
Allow Monitor Regulation for Selection	Enables the parameter that lets the system change the regulation mode to "Monitor" for zones in the Quick Set screen.
Exclude Monitor Zones from At-Temperature	Enables the parameter that lets the system exclude zones that are set to "Monitor" regulation from the "At Temperature" condition.
Wattage Voltage	Insert the designed voltage rating of the heaters so the system can accurately calculate Watt Voltage.
Supply Configuration	Used to select the supply configuration parameter: Delta 3PH, Wye 3PH+N, Single Phase, or Integrated TX.
Global Output Power Limit	Used to control the maximum output power applied to each zone.
Earth Leakage Fault Enable	Enable or disable the earth leakage check.
Earth Leakage Limit	<p>For ICC² cards, a percentage used to calculate the earth leakage limit when the diagnostic process for a zone is complete. The control card uses a percentage of the current measured during the test to make the decision when an earth leakage error occurs.</p> <p>The parameter range is 0 to 100%. The default value is 10%.</p> <p>For ICC³ cards, the value is displayed in milliamps and has an adjustable range from 1 to 999 mA. The default value is 500 mA.</p>
Display Earth Leakage Reading	When ICC ³ cards are installed, this shows the earth leakage.
Circuit Overload Enable	Enables or disables the circuit overload error. This shows only if ICC ³ cards are installed.
Circuit Test Enable	Enables or disables the circuit test for ICC ³ cards.
Auto Power Limiting Enable	When enabled, the controller automatically adjusts the output power limit values on zones that have oversized heaters attached. This setting is disabled by default.
Circuit Test State 4 Power Level	This is the power level that is applied during pre-state 4 when the control card calculates the current during circuit test. The range is from 20% to 50% and the default value is 50%.
Display Causes and Solutions Enable	When enabled, the controller stops the system and alerts the user that failures were detected during circuit test. The controller shows a dialog window of possible causes and solutions data. Refer to Section 16.8 .

Table 10-11 System Setup Screen - Heats Setup - Monitoring 1 (Continued)

Item	Description
Display Failure Data	This button becomes enabled when the system has completed the circuit test and failures have been found. Touch the button to see past test results, so you do not have to run the circuit test again. If no failures are found, then the button stays disabled. Refer to Section 16.8 .
At Temperature Minimum Limit	This is the minimum threshold for activating the At-Temperature signal. The At-Temperature signal is activated on what follows: When all active zone temperatures are higher than the lower alarm limit. If the alarm band setting is lower than the At-Temperature Minimum Limit value, then the At-Temperature Minimum Limit value is used to activate the At-Temperature signal.
At Temperature Delay Timer Enable	Enables or disables the At Temperature Delay Timer feature. This setting is disabled by default.
At Temperature Delay Timer	This is the time interval that the controller waits before it alerts the user and IMM that the mold is "At Temperature". The default value is 00:00:00.
At Temperature Delay Timer Status	This shows the time that remains as the delay timer counts down.
Audible Notification Enable	When enabled, audible alerts are given when the system is "At Temperature".
Audible Notification Interval	This sets the time interval between the audible "At Temperature" alerts. The default is 3 seconds (an alert sounds every 3 seconds).
Test Audible Notification	Use this button to test the "At Temperature" alerts.
Power Deviation	When enabled, a power deviation will trigger a power deviation alarm.
No Heater Detected Enable	When enabled, this feature causes an alarm when a heater has failed or is no longer connected to the circuit.
Current Deviation Enable	Enables or disables the Current Deviation feature. This setting is disabled by default.
Current Deviation Limit	Used to calculate the current deviation limit that would cause an error. The default value is 10%. The minimum value is 1% and the maximum value is 100%.
Current Deviation Minimum Limit	Used as a minimum value that the calculated limit cannot be more than. The default value is 0.50 A. The minimum value is 0.10 A and the maximum value is 5 A.

On the Monitoring 2 tab of the Heats Setup screen, mold monitoring configurations are set for the categories that follow:

- No Heater Detection
- Current Deviation

The Monitoring 2 tab is shown in [Figure 10-20](#) with the configuration settings for each category. The configuration settings are described in [Table 10-12](#).



Figure 10-20 Heats Setup - Monitoring 2

Table 10-12 System Setup Screen - Heats Setup - Monitoring 2

Item	Description
No Heater Detected Enable	When enabled, this feature causes an alarm when a heater has failed or is no longer connected to the circuit.
Current Deviation Enable	Enables or disables the Current Deviation feature. This setting is disabled by default.
Current Deviation Limit	Used to calculate the current deviation limit that would cause an error. The default value is 10%. The minimum value is 1% and the maximum value is 100%.
Current Deviation Minimum Limit	Used as a minimum value that the calculated limit cannot be more than. The default value is 0.50 A. The minimum value is 0.10 A and the maximum value is 5 A.

10.4 Force Temperature Units To

Users can select how the available temperature units are shown with the Force Temperature Units To option: Degrees Celsius (C), degrees Fahrenheit (F), or degrees kelvin (K).

When C, F, or K is selected, all temperatures shown in the system are forced to that unit. This includes all stored mold setups. When a dash is select for this option, users can select their own temperature unit in the Units dialog.

To select the temperature unit of measure, do the steps that follow:

1. On the System Setup screen, touch the **Main 1** tab.
2. Touch the **Configure** button next to Configure Settings.
3. Touch the **Force Temperature Units To** field.
4. Select the temperature unit.

10.5 Units of Measure

Users can configure the Altanium controller to show the international system of units (SI) or the imperial units of measure.

To change the units of measure, do the steps that follow:

1. On the System Setup screen, touch the **Main 1** tab.
2. Touch the **Configure** button next to Configure Settings.
3. Touch the **Units** button.
4. Select the units of measure you want shown on the system.
5. Touch the **Exit** button.

NOTE: If the Altanium controller is forced to a specified setting, only administrators can change the units of measure.

10.6 Equipment Protection

The Equipment Protection function is used to set a timer that alerts users when the servo cabinet air filter must be changed. The time interval can be set from 30 to 365 days. A counter field shows the number of days since the timer was started. There is a reset button for when the filter has been replaced.

To set the air filter reminder, do the steps that follow:

1. On the System Setup screen, touch the **Main 1** tab.
2. Touch the **Air Filter** button below Equipment Protection.
3. Touch the **Change Interval** field.

4. Type the number of days and touch the **Accept** button.
5. Touch the **Change Reminder** checkbox to enable the reminder.
6. When asked, "Are you sure?", touch the **Accept** button.
7. Touch the **Exit** button.

10.7 Power Conservation

To conserve power, the Altanium controller lets you set the display to automatically turn off (change to a dark screen) if it is not used in a set interval of time. When it turns off, touch the screen to turn it on again.

To enable the power conservation feature and set the timer, do the steps that follow:

1. On the System Setup screen, touch the **Main 2** tab.
2. Touch the **Turn Off Display After** field.
3. Type the number of minutes from 1 to 300 and touch the **Accept** button.
4. Touch the **Turn Off Display** checkbox, so the check mark shows.

The power conservation feature is now enabled.

10.8 Part Counting

Optional digital inputs and an output are available to automatically count parts. The system also lets you set a sack full limit, so users do not have to manually calculate when the sack is full.

10.8.1 Set Part Counting

To set Part Counting, do the steps that follow:

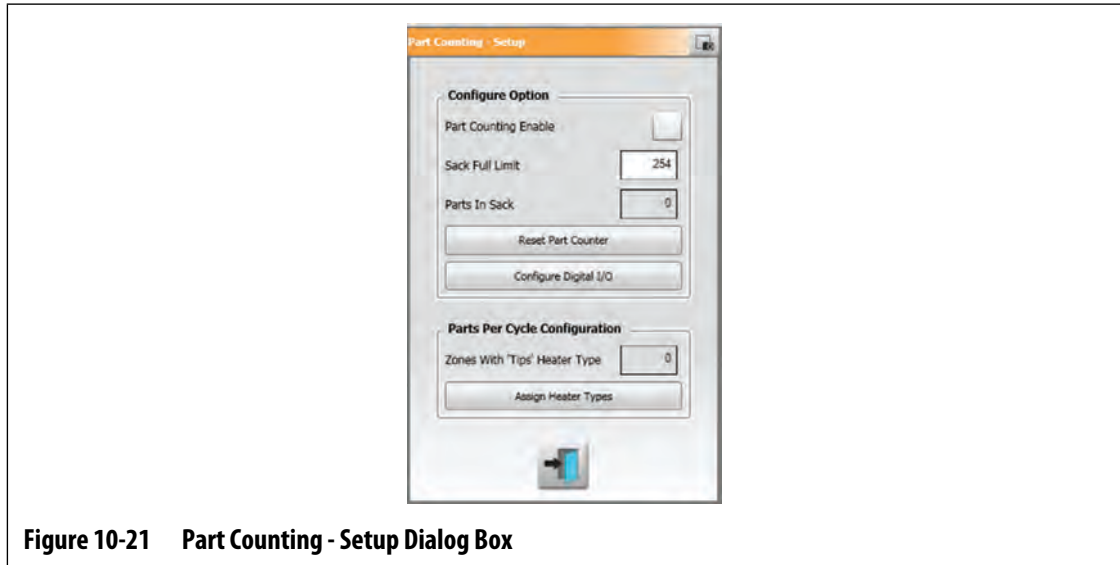
1. On the System Setup screen, touch the **Heats Setup** tab and then the **Control Page 2** tab.
2. Touch the **Setup** button below Part Counting.
The Part Counting - Setup dialog window shows. Refer to [Figure 10-21](#).
3. Touch the **Assign Heater Types** button if this was not done before. This will show the Quick Set screen. For more information refer to [Section 7.8](#).

NOTE: The Heater Type parameter must be set to Tips for all zones of a cavity in the mold. If no zones have a Heater Type parameter assigned, an error message will show.

4. Touch the **Part Counting Enable** checkbox, so the check mark shows.

5. Touch the **Sack Full Limit** field and then enter a quantity of parts that tells the system when the sack is full. You can set the quantity from 1 to 1,000,000.
6. Touch the **Configure Digital I/O** button if this was not done before.
This shows the Digital I/O screen. Refer to [Section 14.1](#) for information on how to configure the digital inputs/outputs.

The Parts in Sack field shows the current number of parts in the sack. The current number of parts is also shown in the system header.



10.8.2 Reset the Part Counter

Digital Input 8 (Reset Parts Counter) automatically resets the Parts in Sack field and the parts shown on the system header to zero when the current part count is equal to or more than to the sack full limit. Refer to [Section 14.1](#) for information on how to configure the digital inputs/outputs.

To manually reset the Part Counter, touch the **Reset Part Counter** button on the Part Counting - Setup dialog window.

The Parts in Sack field and Parts shown on the system header are reset to zero.

10.8.3 Sack Full Output Optimization

The system automatically adjusts the Sack Full Limit if an abort condition error occurs while the system is in the Running state, and the PCM parameter is set to Zone on the Quick Set screen.

To allow the system to optimize the sack full limit, set the PCM - Priority Control Mode to Zone on the Quick Set screen. Refer to [Figure 10-22](#).

The system automatically adjusts the sack full limit when an abort condition error occurs. The list that follows shows abort condition errors:

- Abort Over Temperature
- Abort Under Temperature
- Fuse 1 Blown
- No Response
- Lost T/C
- Reverse T/C
- Fuse 2 Blown
- Earth Leakage
- Over Maximum Temperature Limit
- Over Current Limit
- Configuration
- Receive Data Communication
- Read Time Out
- Control Card Over Temp



Figure 10-22 Quick Set - Priority Control Mode (PCM)

10.9 Remote Load

Mold setups can be loaded directly from the injection molding machine. With the Remote Load option, the injection molding machine can send a signal to the controller on one of up to 1023 input combinations to identify which mold setup to load. The system uses combinations of:

- Six binary inputs - lets the user assign a mold setup to each one of 63 possible combinations.
- Eight binary inputs - lets the user assign a mold setup to each one of 255 possible combinations.
- Ten binary inputs - lets the user assign a mold setup to each one of 1023 possible combinations.

To set up Remote Load, do the steps that follow:

1. On the System Setup screen, touch the **Main 1** tab.
2. Touch the **Setup** button below Remote Load.

The Remote Load - Setup dialog window shows. Refer to [Figure 10-23](#).

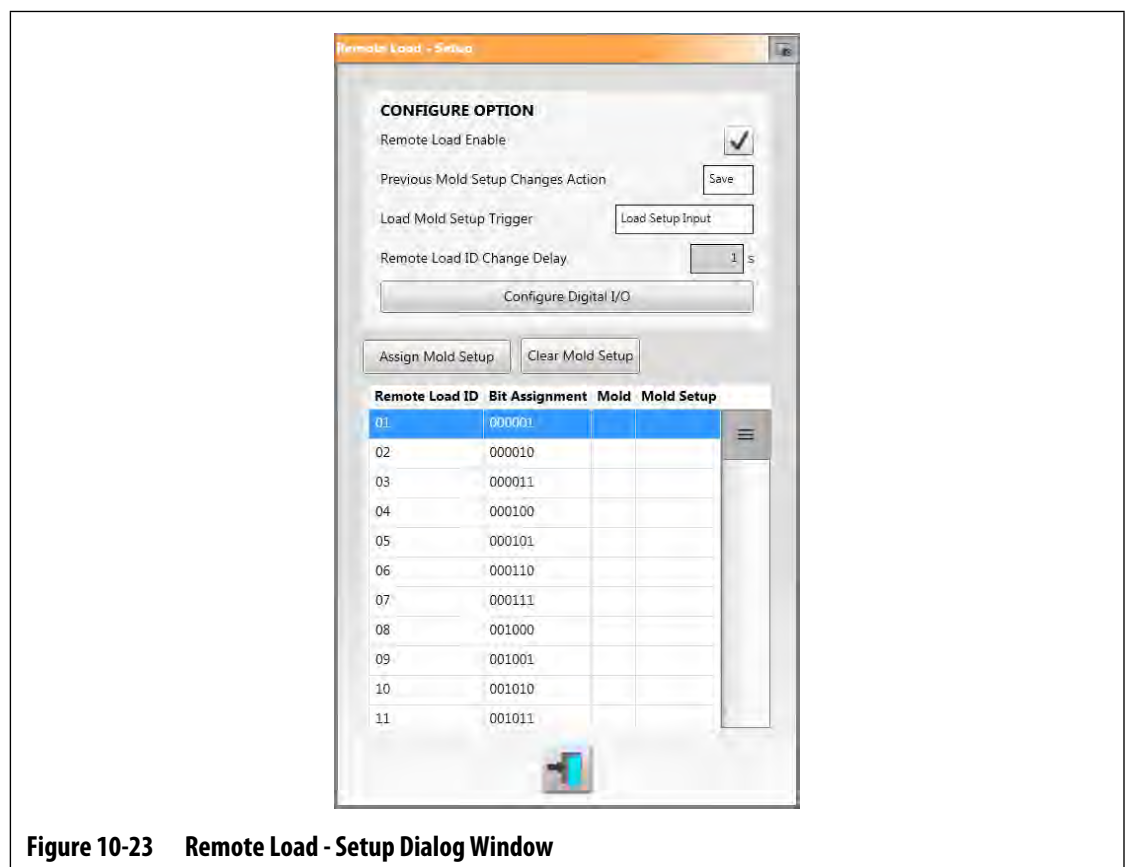


Figure 10-23 Remote Load - Setup Dialog Window

3. Touch the **Remote Load Enable** checkbox so the check mark shows.
4. Touch the **Configure Digital I/O** button if the Digital I/O configuration was not done before.

The Digital I/O screen shows. Refer to [Section 14.1](#) for information on how to configure the digital inputs/outputs.

NOTE: The user can select what to do with changes that were made before to the current mold setup. When a request has been started to load a different mold setup, the system uses this parameter to save or discard the changes.

5. Touch one of the 63 rows that do not have a mold setup assigned.
6. Touch the **Assign Mold Setup** button to start the assignment process.

The Assign Mold Setup dialog window shows the folder structure for the local hard drive only. Refer to [Figure 10-24](#). The Network and USB buttons will not operate when they are touched.

NOTE: Only one mold setup can be selected at a time.



Figure 10-24 Remote Load - Assign Mold Setup Dialog Box

7. Touch a mold setup file to highlight it and then touch the **Accept** button.
The new mold setup that you selected is shown. When the applicable remote load ID is requested, this is the mold setup that will be loaded.
8. To clear the association, touch the row and then touch the **Clear Mold Setup** button.

NOTE: A mold setup cannot be assigned to more than one remote load ID. If the user tries to do this, the current assigned remote load ID is removed automatically and the new remote load ID is added.

10.10 Grid Size and the Group Offset

To change the layout on the Card Layout screen, you must change the grid size. To configure the linked systems, you must change the group offset setting. The default group offset setting is 96 zones.

To change Grid Size, do the steps that follow:

1. On the System Setup screen, touch the **Heats Setup** tab and then the **Control Page 2** tab.
2. Touch the **Grid Size** field below Zone Slot Configuration.
3. Touch a grid size button to select it.
4. Touch the **Group Offset** field.
5. Touch a group offset button to select it.
6. Touch the **Accept** button.

10.11 Zone Alarm Control

To set the Zone Alarm Control values, do the steps that follow:

1. On the System Setup screen, touch the **Heats Setup** tab and then the **Monitoring 1** tab.
2. Below Zone Alarm Control, touch the field that you want to change. Refer to [Table 10-13](#).
3. Type a value and then touch the **Accept** button.

Table 10-13 Zone Alarm Control Settings

Setting	Description
Alarm Sensitivity	The duration of time the system has to stay in an error condition before it alarms. The default value is 2 seconds, and the valid range is from 2 to 60 seconds.
Maximum Temperature Limit	The number of degrees over the setpoint that the Maximum Temperature Alarm is activated. This alarm is used as a failsafe warning if an Abort Over Temperature alarm is ignored. The range is 1° to 500 °C with a default value of 111 °C.
No Response Limit	This is a global setting of how long the system should apply 96% power or greater without a 5 degree increase in temperature before it becomes an alarm condition. The range is 2 to 15 minutes with a default of 4 minutes.

10.12 Monitor Zone Settings

When enabled, the Allow Monitor Regulation For Selection lets the user change the regulation mode to 'Monitor' for zones in the Quick Set screen. If a zone is currently in Monitor regulation when this parameter is de-selected, the system automatically changes the regulation mode to 'Automatic'.

When enabled, the Exclude Monitor Zones From At-Temperature lets the user exclude zones set to Monitor regulation from the At-Temperature condition by the system. By default, monitor zones are included in the At-Temperature condition.

To select the monitor zone settings, do the steps that follow:

1. On the System Setup screen, touch the **Heats Setup** tab and then the **Monitoring 1** tab.
2. Below Monitor Zone Settings, touch the checkbox next to an item you want to enable, so the check mark shows. The items are:
 - **Allow Monitor Regulation for Selection**
 - **Exclude Monitor Zones From At-Temperature**
3. Touch the **Accept** button.

10.13 Power Limiting

Power limiting is used to control the maximum output power supplied to each zone. The output power limit for each zone can be set from 0% to the Global Output Power Limit value. If the Global Output Power Limit value is adjusted lower than the zone setting, then the power limit for each zone is automatically decreased by the system to not exceed the global value.

To set the global output power limit, do the steps that follow:

1. On the System Setup screen, touch the **Heats Setup** tab and then the **Monitoring 1** tab.
2. Touch the **Global Output Power Limit** field below Power Limiting.
3. Enter the percentage and then touch the **Accept** button.

10.14 Power Deviation

The Power Deviation alarm alerts the operator when the power output percentage on any zone deviates a specified amount while running under usual conditions. This information can be used to detect plastic leaks in the nozzle bore or manifold pocket.

To set or make a change to this feature, do the steps that follow:

1. On the System Setup screen, touch the **Heats Setup** tab and then the **Monitoring 1** tab.
2. Touch the **Setup Alarm** button below Power Deviation.

The Setup Alarm dialog window shows. Refer to [Figure 10-25](#).

3. Touch each field to enter the changes and then touch the **Accept** button.
Refer to [Table 10-14](#) for the field descriptions.
4. To enable the feature, touch the **Power Deviation Enable** checkbox, so a check mark shows.
5. To accept changes, touch the **Exit** button.

NOTE: Before the Power Deviation routine can be executed, at least one zone in the system must be classified based on similar function and operation.

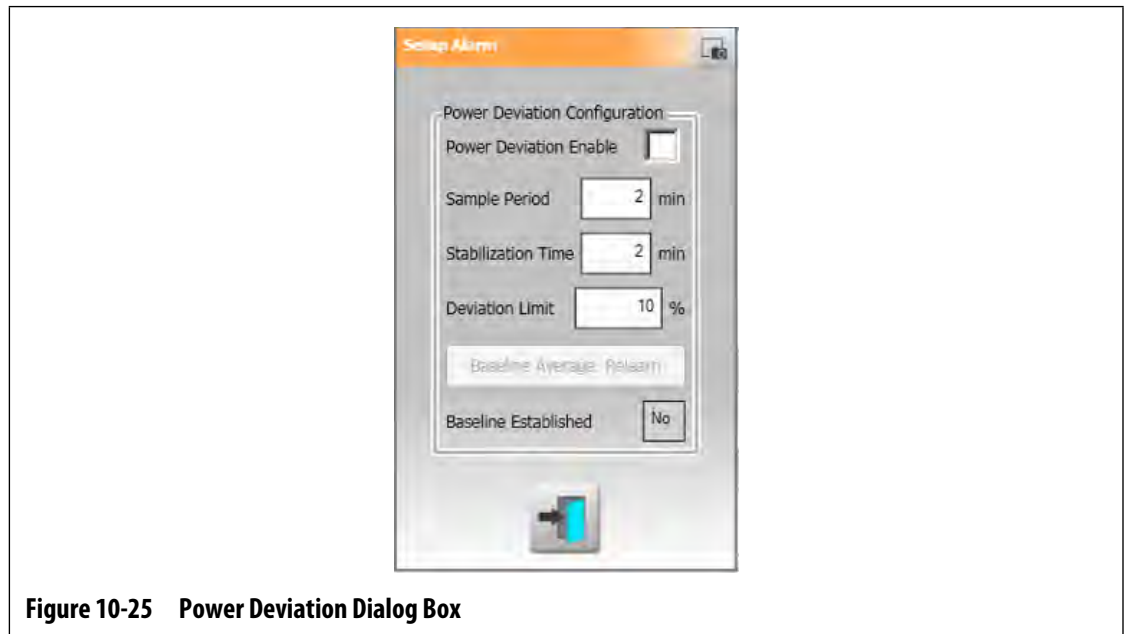


Figure 10-25 Power Deviation Dialog Box

Table 10-14 Power Deviation Settings

Setting	Description
Power Deviation Enable	Used to enable or disable the feature.
Sample Period	The interval of time the system uses to calculate a baseline average power value (that is, to “know” the mold). The default value is 2 minutes, and the range is from 1-10 minutes.
Stabilization Time	The interval of time the system will take after all active zones have reached their setpoints before it starts the Sample Period. The default value is 2 minutes, and the range is from 1-10 minutes.
Deviation Limit Field	This field is used by the system to decide the tolerance value that is used to communicate an error. This value will only be used if the value calculated by the system cannot be used. The default value is 10%, and the range is from 1-100%, specified in 1% increments.

Table 10-14 Power Deviation Settings (Continued)

Setting	Description
Baseline Average Relearn	Use this button to start a new sample period in conditions where the initial sample time was not sufficient to make sure there are good baseline average power values. This button is a manual override that should only be active after all active zones have reached their setpoints and the Stabilization Time has expired.
Baseline Established	This field is used to make the decision if a baseline has been done before for the current loaded mold setup.

10.15 Current Deviation

This monitors if the current draw deviates from the possible known value of the heater while the controller is in operation. The system shows a Current Deviation alarm if the current deviates the percentage set by the user for at least 10 seconds.

To set the Current Deviation, do the steps that follow:

1. On the System Setup screen, touch the **Heats Setup** tab and then the **Monitoring 2** tab.
2. Touch the **Current Deviation Limit** field below Current Deviation.
3. Enter the percentage and touch the **Accept** button.
4. Touch the **Current Deviation Minimum Limit** field.
5. Enter the amperage and touch the **Accept** button.
6. Touch the **Current Deviation Enable** checkbox, so the check mark shows.

10.16 No Heater Detection

When enabled, this feature causes an alarm when a heater has failed or is no longer connected to the circuit. The system compares the current measured for each zone during a test to the No Heater Limit amperage setting on Quick Set screen below Advanced Settings.

To enable the No Heater Detection feature, do the steps that follow:

1. On the System Setup screen, touch the **Heats Setup** tab and then the **Monitoring 2** tab.
2. Touch the **No Heater Detected Enable** checkbox below No Heater Detection, so the check mark shows.

10.17 Energy Usage and Units

Energy accumulation data is updated every three seconds and shown in real time to the user on the Energy Display screen. Users can set the Energy Cost Rate (Kwh) and Currency Type.

To change the energy usage and units, do the steps that follow:

1. Touch the **Energy Display** button on the Home screen.
The Energy Display screen shows. Refer to [Figure 10-26](#).
2. Touch the **Energy Cost Rate (Kwh)** field below Energy Usage and Units.
3. Enter the kWh cost rate and touch the **Accept** button.
4. Touch the **Currency Type** button field below Energy Usage and Units.
5. Touch the currency type from the list.

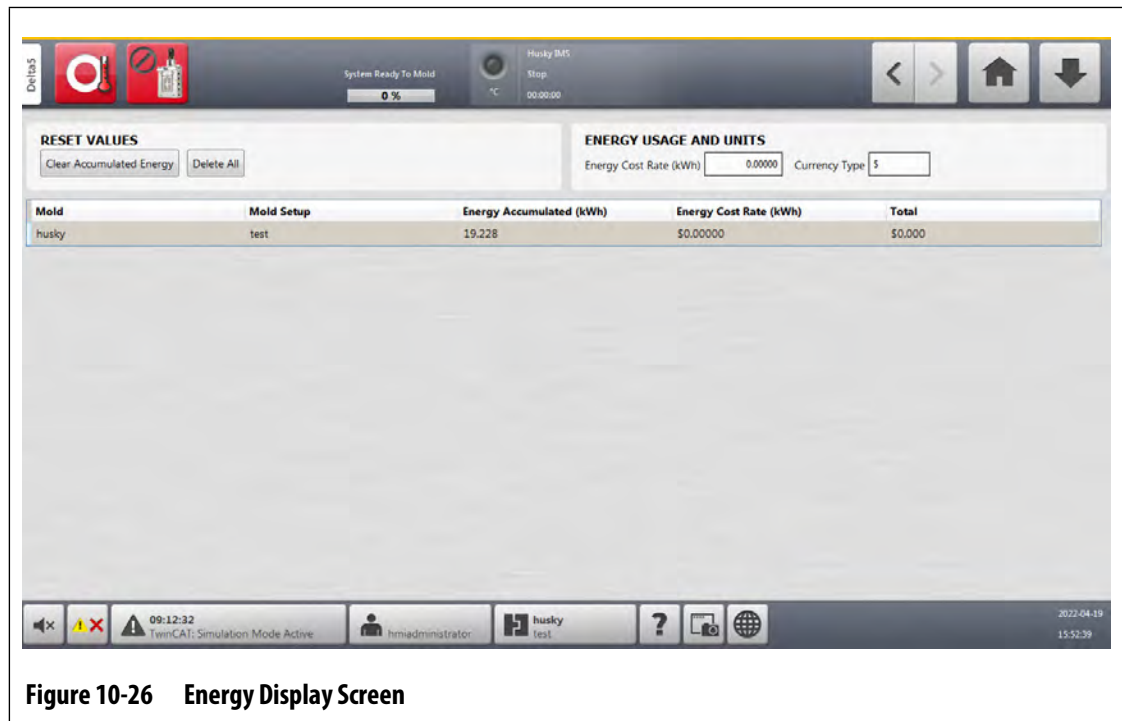


Figure 10-26 Energy Display Screen

10.18 Number of Zones in the System

It could be necessary to add or remove zones to an current mold setup. If the mold that is running has less control zones than those listed on the Altanium controller screen, users can remove the unused zones so they are not shown.

To change the number of zones in the system, do the steps that follow (refer to [Figure 10-27](#)):

1. From the Home screen, touch the **Zone Slot** button.
2. Touch the zones that will be enabled or disabled.
3. Touch the **Slot Enable** field.

4. Touch the **Enable** or **Disable** button.
5. Reboot the Altanium controller.



Figure 10-27 Zone Slot Screen

10.19 Standby Timer Settings

To decrease the temperatures in the mold for a specified period of time, set the standby timers related with each standby function. When the system enters standby, the timer starts. When the timer completes, the temperatures increase back to the setpoint.

10.19.1 Set the Manual Standby Duration Timer

The zone temperature decreases for a specified time duration or until it gets to a set standby temperature.

To set the Manual Standby Duration Timer, do the steps that follow:

1. On the System Setup screen, touch the **Heats Setup** tab and then touch the **Control Page 1** tab.
2. Touch the **Manual Standby Duration Timer** field that is below Manual Standby and Boost.
3. Enter the time requirement in this format: HHMMSS.
4. Touch the **Accept** button.

10.19.2 Set the Remote Standby Duration Timer

The zone temperature decreases for a specified time duration or until it gets to a set remote standby temperature.

NOTE: If the remote standby feature is not installed on the system, only the Manual Standby Duration Timer setting is shown on the screen.

To set the Remote Standby Duration Timer, do the steps that follow:

1. On the System Setup screen, touch the **Heats Setup** tab and then touch the **Control Page 1** tab.
2. Touch the **Remote Standby Duration Timer** field that is below Remote Standby.
3. Enter the time requirement in this format: HHMMSS.
4. Touch the **Accept** button.

10.19.3 Set the Remote Standby Delay Timer

The Remote Standby Delay Timer is a feature available with remote standby. Use this delay timer to protect the product material, so it does not get burned if the molding machine is stopped for a specified time period. If the Remote Standby Delay Timer is set, the Altanium controller will not decrease the temperatures until the delay time has elapsed.

For example, when the operator gate on the molding machine is opened, a signal to start the Remote Standby Delay Timer could be sent to the Altanium controller. If the operator gate is closed before the delay time has elapsed, the controller will not enter standby. If the operator gate stays open, the controller then enters standby.

NOTE: If the remote standby feature is not installed on the system, only the Manual Standby Duration Timer setting is shown on the screen.

To set the Remote Standby Delay Timer, do the steps that follow:

1. On the System Setup screen, touch the **Heats Setup** tab and then touch the **Control Page 1** tab.
2. Touch the **Remote Standby Delay Timer** field that is below Remote Standby.
3. Enter the time requirement in this format: HHMMSS.
4. Touch the **Accept** button.

10.19.4 Set the Remote Standby Input Mode

The Remote Standby Input Mode setting is enabled by one of three settings: Trigger, On/Off, or Direct.

NOTE: This setting does not show if the remote standby option is not installed on the system.

To change the Remote Standby Input mode, do the steps that follow:

1. On the System Setup screen, touch the **Heats Setup** tab and then touch the **Control Page 1** tab.
2. Touch the **Remote Standby Input Mode** field that is below Remote Standby.
3. Touch mode in the list to select it.

10.19.5 Standby Operation Description

The settings for manual and remote standby operations are described in [Table 10-15](#) and [Table 10-16](#).

Table 10-15 Manual Standby Operational Description

Manual Time	Delay Time	Remote Time	Input Mode	Cycle Enabled	Operation - STANDBY Button Select
0:00:00	----	----	----	----	System enters Standby indefinitely.
X:XX:XX	----	----	----	----	System remains in Standby until the timer completes.

If it is necessary to cancel the manual standby duration timer, touch the **Start** or **Stop** buttons.

Table 10-16 Remote Standby Operational Description

Manual Time	Delay Time	Remote Time	Input Mode	Cycle Enabled	Operation - STANDBY Button Select
----	0:00:00	0:00:00	Trigger	----	System does not enter Standby, because no timers are set.
----	0:00:00	X:XX:XX	Trigger	----	System immediately enters and remains in Standby until the timer completes.
----	X:XX:XX	X:XX:XX	Trigger	No	System delays for a specified time and then enters Standby until the timer completes.
----	X:XX:XX	0:00:00	Trigger	No	System delays for specified time and then enters Standby indefinitely.

Table 10-16 Remote Standby Operational Description (Continued)

Manual Time	Delay Time	Remote Time	Input Mode	Cycle Enabled	Operation - STANDBY Button Select
----	X:XX:XX	X:XX:XX	Trigger	Yes	System delays for a specified time and then enters Standby until the timer completes. If the input signal changes state while the delay timer is active, the delay timer is reset to the specified value.
----	X:XX:XX	0:00:00	Trigger	Yes	System delays for specified time and then enters Standby indefinitely. If the input signal changes state while the delay timer is active, the delay timer is reset to the specified value.
----	0:00:00	0:00:00	ON/OFF	----	System enters Standby until the input signal is not active.
----	0:00:00	X:XX:XX	ON/OFF	----	System enters Standby until the input signal is not active or the timer completes.
----	X:XX:XX	X:XX:XX	ON/OFF	----	System delays for a specified time and then enters Standby until the signal is not active or the timer completes.
----	X:XX:XX	0:00:00	ON/OFF	----	System delays for a specified time and then enters Standby until the input signal is not active.
----	----	----	Direct	----	System enters Standby until the input signal is not active. If the input signal is active when the system is started, it will immediately go into Standby mode.

To cancel the remote standby duration timer, touch the **Start** or **Stop** buttons.

10.20 Boost Timer Settings

To increase the temperatures in the mold for a specified period of time, set the boost timers related with each boost function. When the system enters Boost, the timer starts. When the timer completes, the temperatures decrease back to the setpoint.

10.20.1 Set the Manual Boost Duration Timer

Use the Manual Boost Duration Timer to set a duration period for the zones to heat up to the manual boost setpoint limit.

To set the Manual Boost Duration Timer, do the steps that follow:

1. On the System Setup screen, touch the **Heats Setup** tab and then touch the **Control Page 1** tab.
2. Touch the **Manual Boost Duration Timer** field that is below Manual Standby and Boost.
3. Enter the time requirement in this format: HHMMSS.
4. Touch the **Accept** button.

10.20.2 Set the Remote Boost Duration Timer

The input option settings make the decision how the system reacts when it receives the remote boost input.

NOTE: If remote boost is not installed on the system, only the Manual Boost Duration Timer field is shown on the screen.

To set the Remote Boost Duration Timer, do the steps that follow:

1. On the System Setup screen, touch the **Heats Setup** tab and then touch the **Control Page 1** tab.
2. Touch the **Remote Boost Duration Timer** field that is below Remote Boost.
3. Enter the time requirement in this format: HHMMSS.
4. Touch the **Accept** button.

10.20.3 Set the Remote Boost Delay Timer

Use the Remote Boost Delay Timer to wait for a specified period before the system enters boost mode.

To set the Remote Boost Delay Timer, do the steps that follow:

1. On the System Setup screen, touch the **Heats Setup** tab and then touch the **Control Page 1** tab.
2. Touch the **Remote Boost Delay Timer** field that is below Remote Boost.

3. Enter the time requirement in this format: HHMMSS.
4. Touch the **Accept** button.

10.20.4 Change the Remote Boost Input Mode

The Remote Boost Input Mode setting is enabled by one of three settings: Trigger, On/Off, or Direct.

NOTE: If remote boost is not installed on the system, the Remote Boost Input Mode field will not show on the screen.

To change the Remote Boost Input Mode, do the steps that follow:

1. On the System Setup screen, touch the **Heats Setup** tab and then touch the **Control Page 1** tab.
2. Touch the **Remote Boost Input Mode** field that is below Remote Boost.
3. Touch mode in the list to select it.

10.20.5 Boost Operation Description

The settings for manual and remote boost operations are described in [Table 10-17](#) and [Table 10-18](#).

Table 10-17 Manual Boost Operational Description

Manual Time	Delay Time	Remote Time	Input Mode	Cycle Enabled	Operation - BOOST Button Select
0:00:00	----	----	----	----	System enters Boost indefinitely.
X:XX:XX	----	----	----	----	System remains in Boost until the timer completes.

If it is necessary to cancel Manual Boost, touch the **Start** or **Stop** buttons.

Table 10-18 Remote Boost Operational Description

Manual Time	Delay Time	Remote Time	Input Mode	Operation - Boost Button Select
----	0:00:00	0:00:00	Trigger	System will not enter Boost because no timers are set.
----	0:00:00	X:XX:XX	Trigger	System immediately enters and remains in Boost until the timer completes.
----	X:XX:XX	X:XX:XX	Trigger	System delays for specified time and then enters Boost until the timer completes.
----	X:XX:XX	0:00:00	Trigger	System delays for specified time and then enters Boost indefinitely.

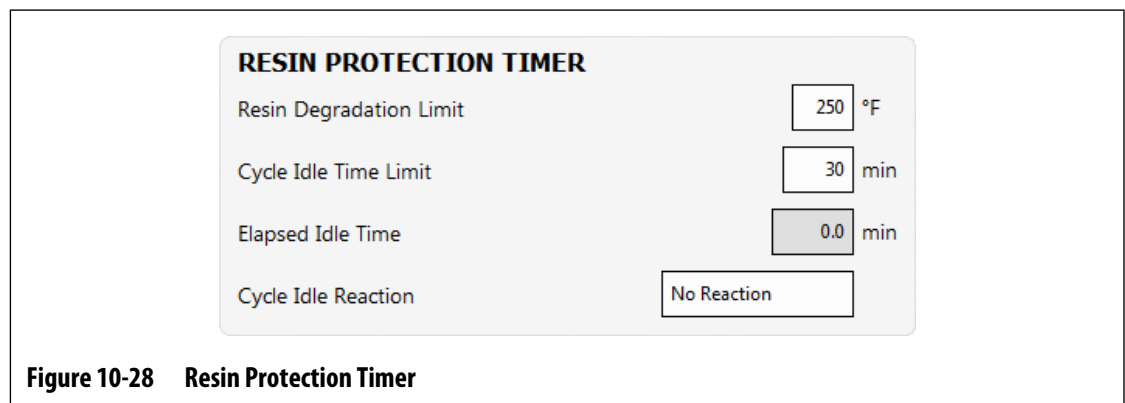
Table 10-18 Remote Boost Operational Description (Continued)

Manual Time	Delay Time	Remote Time	Input Mode	Operation - Boost Button Select
----	0:00:00	0:00:00	ON/OFF	System enters Boost until the input signal is not active.
----	0:00:00	X:XX:XX	ON/OFF	System enters Boost until the input signal is not active or the timer completes.
----	X:XX:XX	X:XX:XX	ON/OFF	System delays for specified time and then enters Boost until the input signal is not active or the timer completes.
----	X:XX:XX	0:00:00	ON/OFF	System delays for specified time and then enters Boost until the signal is not active.
----	----	----	Direct	System enters Standby until the input signal is not active. If the input signal is active when the system is started, it will immediately go into Standby mode.

To cancel Remote Boost, touch the **Start** or **Stop** buttons.

10.21 Resin Protection Timer

The Resin Protection Timer is used to protect the resin from degrading. Refer to [Figure 10-28](#).



The timer is triggered when one of the heat zones is more than the user specified limit and the controller is not auto cycling. The timer is reset by the events that follow:

- The controller starts to auto cycle.
- All of the heat zone temperatures decrease to less than the resin degradation limit temperature.
- The user changes the controller mode to Start, Stop, or Standby.

10.21.1 Set the Resin Degradation Limit

The Resin Degradation Limit is the temperature used to make the decision when to start the timer. The default value is 121 °C (250 °F).

To set the Resin Degradation Limit, do the steps that follow:

1. On the System Setup screen, touch the **Heats Setup** tab and then touch the **Control Page 1** tab.
2. Touch the **Resin Degradation Limit** field that is below Resin Protection Timer.
3. Enter the temperature and then touch the **Accept** button.

10.21.2 Set the Cycle Idle Time Limit

The Cycle Idle Time Limit is the duration of time that must elapse before the system does one of the reactions. The timer starts when one of the zone's actual temperature is at or more than the Resin Degradation Limit and the controller is not cycling. The timer resets when one of those conditions is no longer TRUE. The timer can be set between a minimum of 1 minute and a maximum of 90 minutes. The default value is 30 minutes.

To set the Cycle Idle Time Limit, do the steps that follow:

1. On the System Setup screen, touch the **Heats Setup** tab and then touch the **Control Page 1** tab.
2. Touch the **Cycle Idle Time Limit** field that is below Resin Protection Timer.
3. Enter the time and then touch the **Accept** button.

NOTE: Below the Cycle Idle Time Limit is the Elapsed Idle Time field, which shows the time that has elapsed from when the timer was started. This updates in one-minute increments.

10.21.3 Set the Cycle Idle Reaction

The Cycle Idle Reaction is the operation that occurs if the Cycle Idle Time Limit expires. The reactions that can be selected are:

- No Reaction – No operation is done.
- Warning Notification – An alarm is activated when the timer completes.
- Put Heats in Standby (Default Value) – The controller enters Manual Standby mode automatically. An alarm is also activated.
- Turn Heats Off – The controller turns off automatically and an alarm is activated. The alarm then de-activates because the system turns off.

To set the Cycle Idle Reaction, do the steps that follow:

1. On the System Setup screen, touch the **Heats Setup** tab and then touch the **Control Page 1** tab.
2. Touch the **Cycle Idle Reaction** field that is below Resin Protection Timer.
3. Touch the reaction in the list to select it.

10.22 Auto Power Limiting

Auto Power Limiting lets the controller automatically adjust the output power limit values on zones that have oversized heaters attached. When this feature is enabled, the Global Output Power Limit parameter is disabled. This is so a user cannot accidentally adjust the output power limit value on all the zones. When auto power limiting is disabled the Global Output Power Limit parameter is enabled again. This setting is disabled by default.

When the controller automatically adjusts the output power limit values, it also saves the changes to the loaded mold setup. The output power limit values will only change if the current that is reported by the circuit test results is more than the designed current limit (5, 16, or 30 amperes) for the card. The system will not adjust the output power limit lower than 25%. To use a lesser value will not apply enough power to heat the zone to the setpoint, and it will take more time to do so.

To enable Auto Power Limiting, do the steps that follow:

1. From the Home screen, touch the **System Setup** button.
2. Touch the **Heats Setup** tab at the bottom of the screen and then the **Monitoring 1** tab.
3. Touch the **Auto Power Limiting Enable** checkbox below Circuit Test, so the check mark shows.

NOTE: Auto Power Limiting must be disabled for the Global Output Power Limit to be enabled.

10.23 Options and Licensing

Users receive a factory-set license key that contains licensing information. Four I/O options are included with each controller that are selected on the Digital I/O screen. For information on configuring options, refer to [Section 14.1](#).

Users can purchase additional options such as 8 I/Os, All I/Os, Remote Load, Part Counting and SPI interface by contacting Husky for an electronic license file.

To view your system's licensing information, do the steps that follow:

1. From the Home screen, touch the **System Setup** button.
2. Touch the **Main 1** tab at the bottom of the screen.
3. Touch the **View License** button that is below Options and Licensing.

The View License window shows. Refer to [Figure 10-29](#).

NOTE: The green illuminated indicators show the options that are installed on your system.

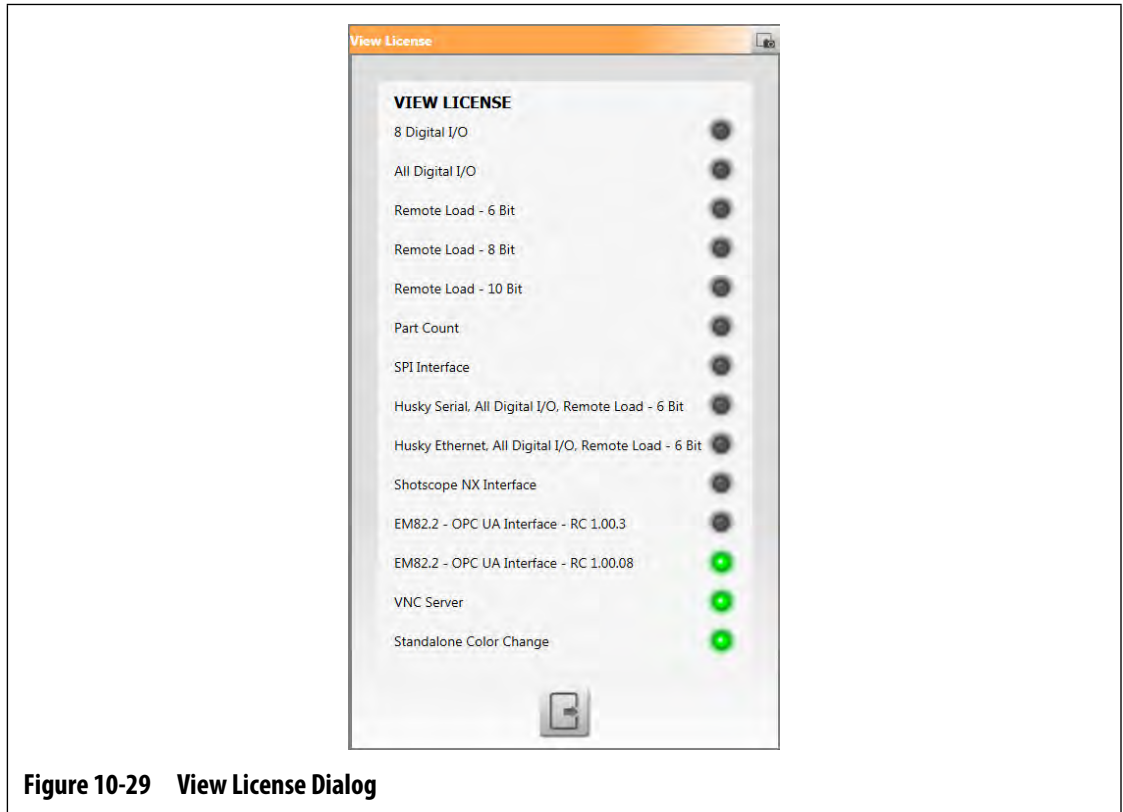


Figure 10-29 View License Dialog

Users can update license files from local, USB, and network drives.

To update licensing information, do the steps that follow:

1. From the Home screen, touch the **System Setup** button.
2. Touch the **Main 1** tab at the bottom of the screen.
3. Touch the **Update License** button that is below Options and Licensing.
4. Upload the new license, as applicable.
5. When the update has completed, a confirmation dialog shows on screen.
6. Touch the **Accept** button.

10.24 Diagnostics Export

Diagnostics Export is used to export diagnostics files to a USB drive. This feature is for Husky Technical Support use only. Please contact Husky for assistance if necessary.

10.25 Mold Cooling Enable

The Mold Cooling Enable Limit sets the threshold that the system uses to make the decision when to activate or deactivate the Mold Cooling Enable output.

Digital Output 5 is activated when this output's "In Use" checkbox is selected, and all automatic zone temperatures have increased more than the Mold Cooling Enable Limit. This output is de-activated when the system is in the 'Stop' state and all automatic zone temperatures have decreased to less than the same limit.

To set the Mold Cooling Enable value, do the steps that follow:

1. From the System Setup screen, touch the **Heats Setup** tab at the bottom of the screen and then the **Control Page 1** tab.
2. Touch the **Mold Cooling Enable Limit** field that is below Mold Cooling Enable.
3. Enter the temperature and then touch the **Accept** button.

10.26 Staged Startup and Shutdown

This feature allows the system to heat or cool zones in a specified order with the use of stages. Zones can be assigned to any of the four stages and can be configured with a separate set point for each stage. A timer can also be configured for each stage that lets all the zones to "soak" for a user specified amount of time. The hot runner system must be heated and cooled in a specified order to prevent problems, such as misalignment and leakage.

10.26.1 Staging Screen

Use the Staging screen to assign zones to stages, set stage setpoints, and enter soak timers for each stage.

Figure 10-30 and Figure 10-31 show the Startup and Shutdown panels of the Staging screen. The configuration settings are described in Table 10-19.

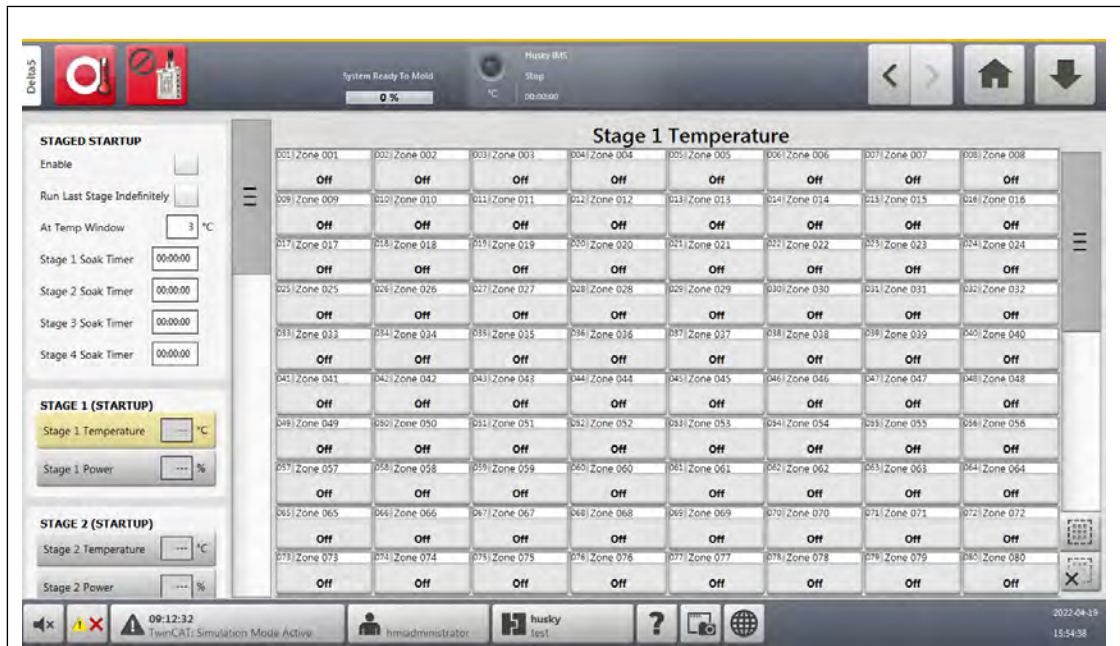


Figure 10-30 Staging Screen - Startup

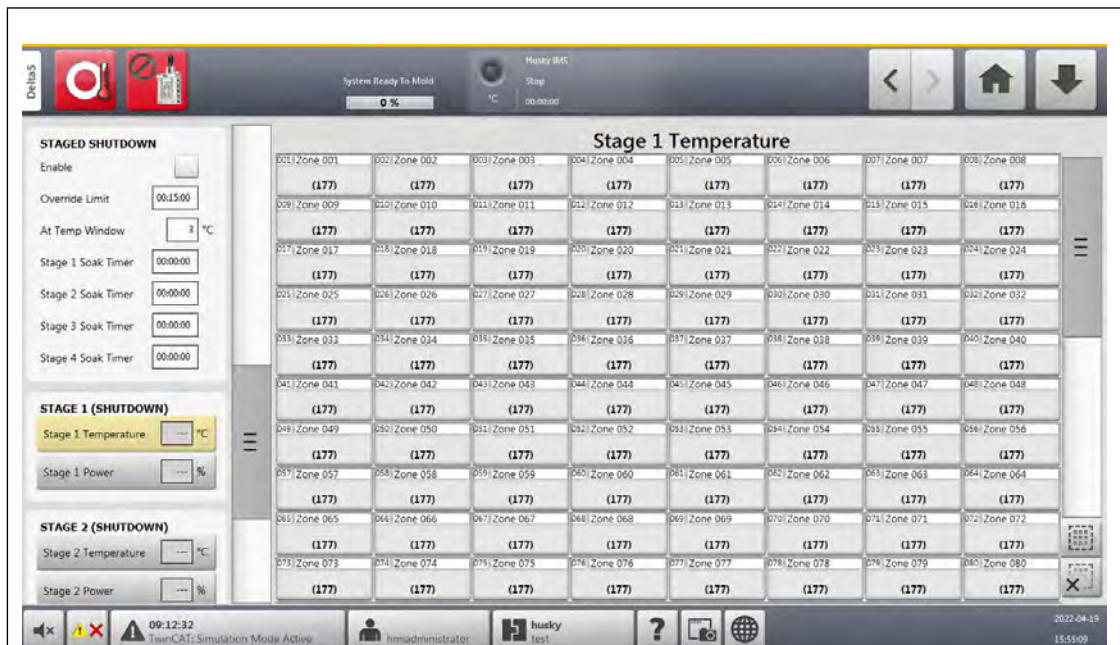


Figure 10-31 Staging Screen - Shutdown

Table 10-19 Staging Screen Settings

Item	Description
Staged Startup Enable	Enables or disables the staged startup sequence.
Run Last Stage Indefinitely	When enabled, all zones in the last assigned stage will not change to their normal setpoint when all zones have achieved the stage setpoint and the soak timer has completed.
At Temp Window	This is used to determine when all automatic zones assigned to a stage have reached a point where the controller can move on to another stage or start the soak timer. If a soak timer is started, then after it completes, the system will move on to the next stage. The temperature window range is 1 °C to 28 °C (2 °F to 50 °F). The is default value is 3 °C (5 °F).
Stage x Soak Timer	The time duration at each stage the zones “soak” at their stage setpoints before the next stage begins.
Stage x Temperature	The temperature setpoint that the zone heats to during stage x.
Stage x Power	The setpoint that is used when zones are in manual regulation during stage x.
Staged Shutdown Enable	Enables or disables the staged shutdown sequence.
Staged Shutdown Override Limit	This limit is used during staged shutdown. If all the zones in the stage have not decreased to the stage setpoint temperature in the override time limit, the system automatically starts the next stage. If no zones are assigned to the next stage, then the system will turn off.

10.26.2 Enable/Disable Staged Startup

Users can enable or disable the Staged Startup feature on the Staging screen. The Staged Startup process is used to control how the temperature increases (heats) in the system.

To enable or disable Staged Startup, do the steps that follow:

1. From the Home screen, touch the **Staging** button.
2. On the Staging screen, do one of the tasks that follow:
 - To enable Staged Startup, touch the **Enable** checkbox that is below Staged Startup, and then touch the **Accept** button in the Warning window that shows on the screen. A check mark shows in the Enable checkbox.
 - To disable Staged Startup, touch **Enable** checkbox that is below Staged Startup to clear the check mark.

10.26.3 Enable or Disable Staged Shutdown

Users can enable or disable the Staged Shutdown feature on the Staging screen. The Staged Shutdown process is used to control how the temperature decreases (cools) in the system.

To enable or disable Staged Shutdown, do the steps that follow:

1. From the Home screen, touch the **Staging** button.
2. On the Staging screen, do one of the tasks that follow:
 - To enable Staged Shutdown, touch the **Enable** checkbox that is below Staged Shutdown, and then touch the **Accept** button in the Warning window that shows on the screen.
 - To disable Staged Shutdown, touch the **Enable** checkbox that is below Staged Shutdown to clear the check mark.

10.26.4 Set the Staged Temperature and Power Setpoints

Use the Staging screen to assign temperature and power for one to four stages.

To assign zones to a stage, do the steps that follow:

1. On the Staging screen, select the zones to be staged.
2. Touch the **Stage 1 Temperature** field.
3. Enter the temperature and then touch the **Accept** button.
4. Touch the **Stage 1 Power** field.
5. Enter the power percentage and then touch the **Accept** button.
6. To assign zones to the other stages, do [step 1](#) through [step 5](#) again.

10.26.5 Hold a Stage Setpoint

Use the Hold setting to use the previous stage setpoint as the value for the selected stage setpoint. Use the Staging screen to assign the Hold setting.

To set the Hold setting, do the steps that follow:

1. On the Staging screen, select the zones to hold.
2. Touch a **Stage x Temperature** field.
3. Touch the **Hold** button.

NOTE: There is no Hold button for the Stage 1 Temperature setting that is below Staged Startup.

10.26.6 Set the Soak Timers

At the end of each stage during staged startup or shutdown, when all zones are at their stage setpoints, they can “soak” for a specified time before the next stage starts. Use the Staging screen to change the soak time durations.

NOTE: It is not necessary to assign a soak time to each stage. To prevent a delay between when a stage is at its setpoint and before the stage that follows is activated, set the timer to 00:00:00.

To set soak timers, do the steps that follow:

1. On the Staging screen, touch the **Stage x Soak Timer** field that will be set.

NOTE: It is not necessary to select zones to set the soak timer.

2. Enter the time required in the format: HHMMSS.
Soak timers have a range of 00:00:00 to 23:59:59.
3. Touch the **Accept** button.
4. Do [step 1](#) through [step 3](#) again for each stage in which a soak time is necessary.

10.27 Supply Voltage Screen

The Supply Voltage screen shows a graphical view of the phase pairs from the Supply Configuration parameter selected in the System Setup screen (in the Heats Setup and Monitoring tabs):

- Delta 3PH
- Wye 3PH+N
- Single Phase
- Integrated TX

On the Home screen, touch the **Supply Voltage** button to see the Supply Voltage screen.

The Supply Voltage screen shows a graphic image of the type of configuration that has been selected. The four supply configurations are shown in [Figure 10-32](#), [Figure 10-33](#), [Figure 10-34](#), and [Figure 10-35](#). The areas of the Supply Voltage screen are described in [Table 10-20](#).

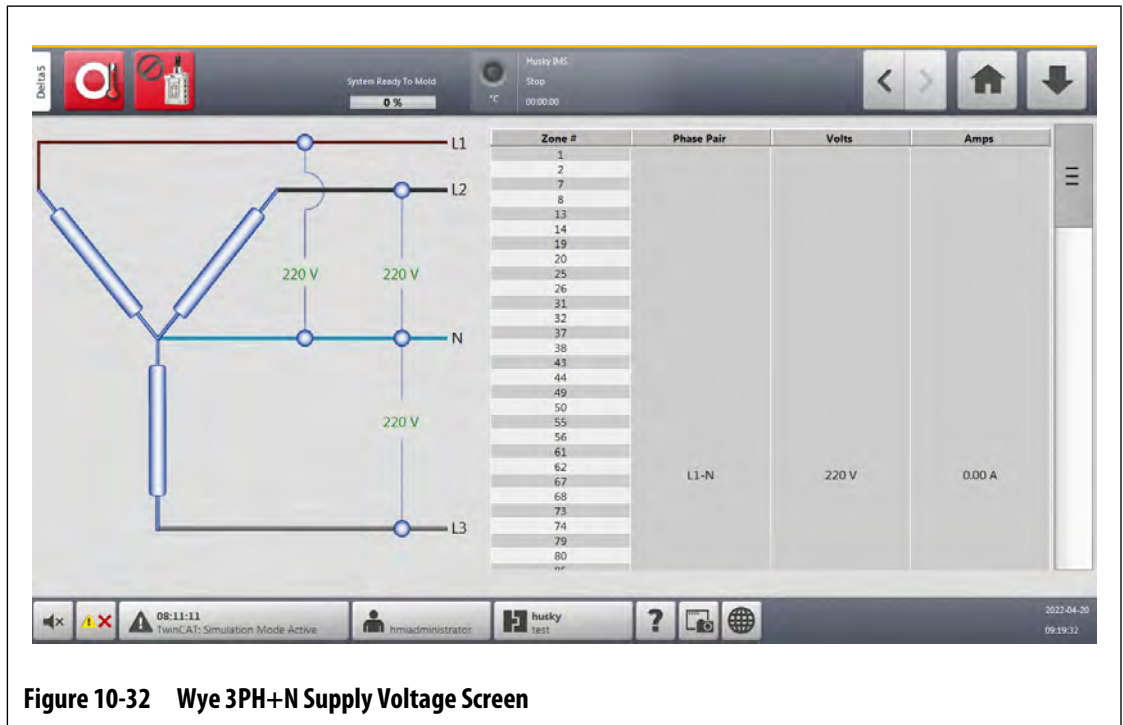


Figure 10-32 Wye 3PH+N Supply Voltage Screen

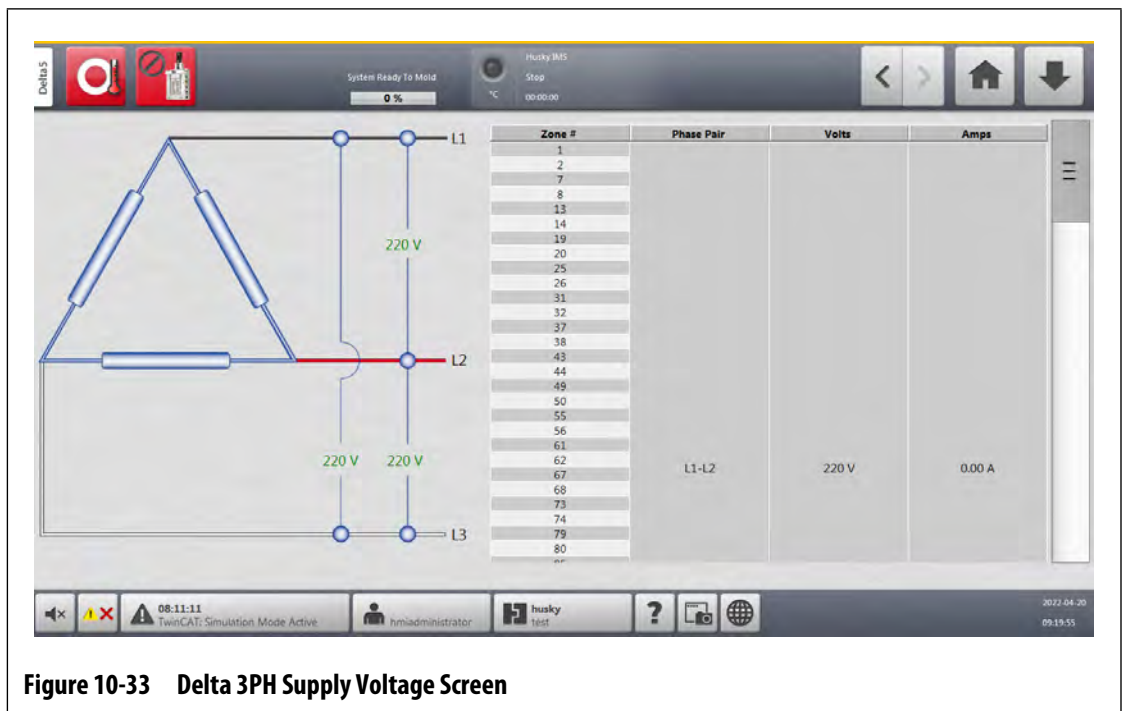


Figure 10-33 Delta 3PH Supply Voltage Screen

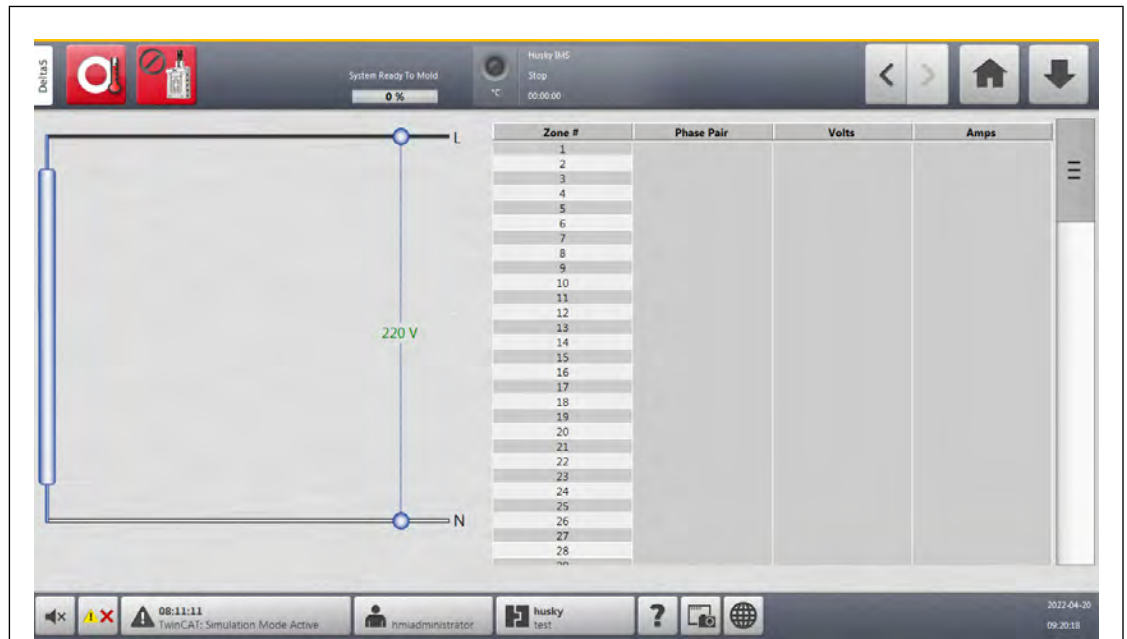


Figure 10-34 Single Phase Supply Voltage Screen

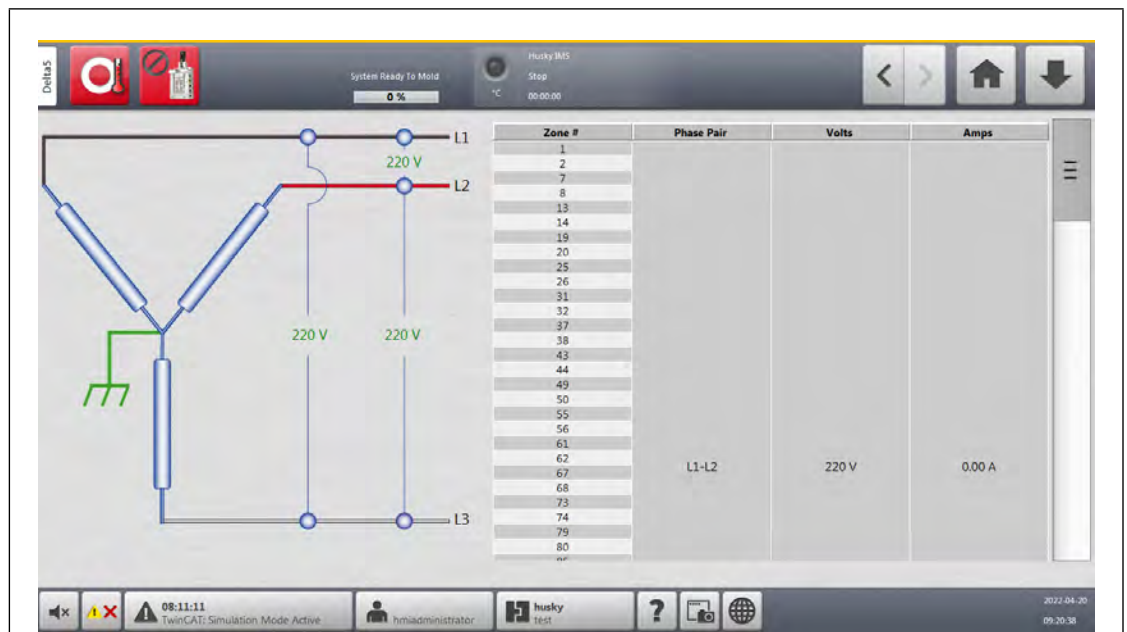


Figure 10-35 Integrated TX Supply Voltage Screen

Table 10-20 Supply Voltage Screen Areas

Item	Description
Schematic	The image is a graphic that shows the supply configuration.
Zone #	The zone number of all the zones related to a phase pair.
Phase Pair	The phase pair label related to the supply configuration graphic.
Volts	The average voltage value for all the zones related to a phase.
Amps	The average amperage value for all the zones related to a phase.

NOTE: The amperage value shows one decimal place for systems with ICC² cards installed and two decimal places for systems with ICC³ cards installed. Both voltage and amperage values display “---” if the voltage and amperage are not calibrated for all the zones related to a particular phase. The amperage value also displays “---” if all of the zones related to an applicable phase are XL or HL cards.

10.27.1 Configure the Supply Voltage

The Altanium controller is configured at the factory for the supply configuration. If the system is moved to a new location where the power configuration is different (for example, the system is moved to a different country), the setting may need to be changed.

To configure the supply voltage, do the steps that follow:

1. On the Home screen, touch the **System Setup** button.
2. Touch the **Heats Setup** tab and then the **Monitoring 1** tab.
3. Below Voltage Settings, touch the **Supply Configuration** field.
4. Touch the correct supply configuration on the Supply Configuration dialog window. Refer to [Figure 10-36](#).



Figure 10-36 Supply Configuration Dialog Window

Chapter 11 Mold Picture View

This chapter describes how to use the mold picture view.

11.1 Mold Picture View Graphic

You can load a mold picture view graphic from one of the sources that follow:

- Local drive
- USB drive
- Network

With a picture of the mold loaded, you can add information panels to the picture that identify the zones. Each panel contains a zone number and two items of information that you can select. Refer to [Section 11.3.2.3](#) to see the selections.

11.1.1 Map a Network Drive

If you load a mold picture view graphic from the network, make sure the Altanium is mapped to the correct network drive.

To map a network drive, do the steps that follow:

1. On the Home screen, touch the **System Setup** button.
2. Touch the **Network** tab.
3. Touch the **Location** field and then type the network location.
4. Touch the **Accept** button.
5. Touch the **Domain Name** field and then type the domain name.
6. Touch the **Accept** button.
7. If necessary, touch the **User Name** and **Password** fields and enter the applicable information.

11.1.2 Load a Mold Picture View Graphic

The Altanium can show up to five different images in the mold picture view. To load a mold picture view graphic, do the steps that follow:

1. On the Home screen, touch the **Mold Picture View** button.

The Mold Picture View screen shows. Refer to [Figure 11-1](#).

NOTE: To change a mold picture view graphic that has been loaded, touch the name of the view that contains the mold picture view graphic to be changed.

2. Touch a name (Tips, Manifolds, Sprue, or Maintenance) in the Views panel to upload the new mold picture view graphic.

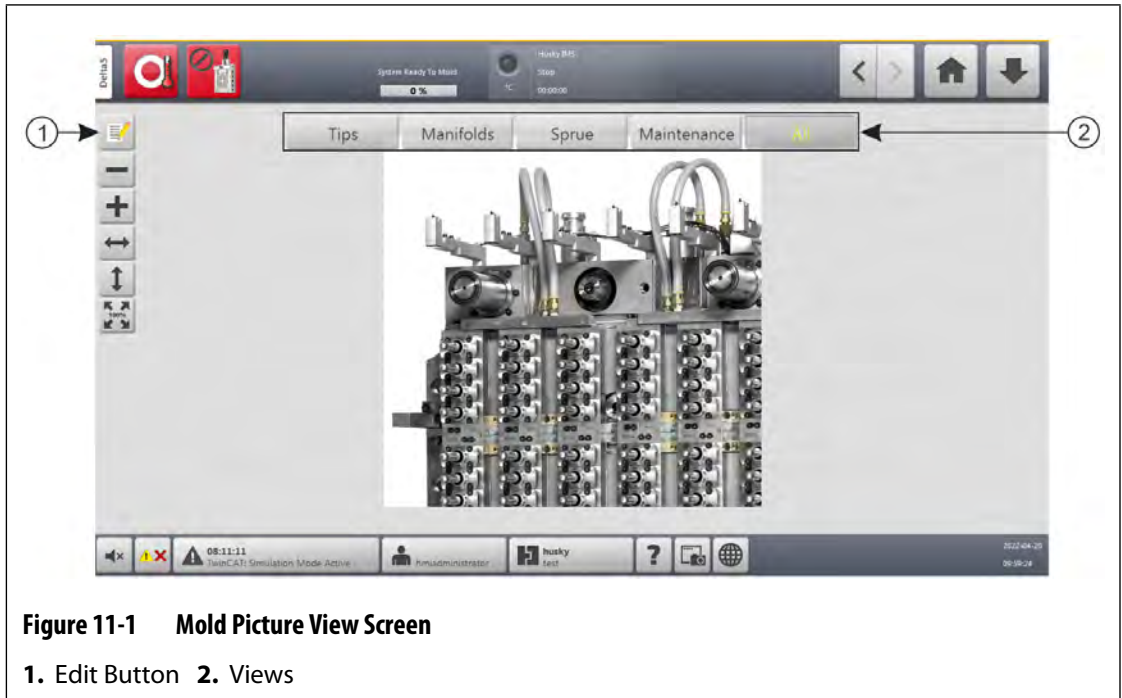


Figure 11-1 Mold Picture View Screen

1. Edit Button
2. Views

3. Touch the **Edit** button.
4. Touch the **Change View Settings** button.



The Change View Settings Dialog Window shows. Refer to [Figure 11-2](#).

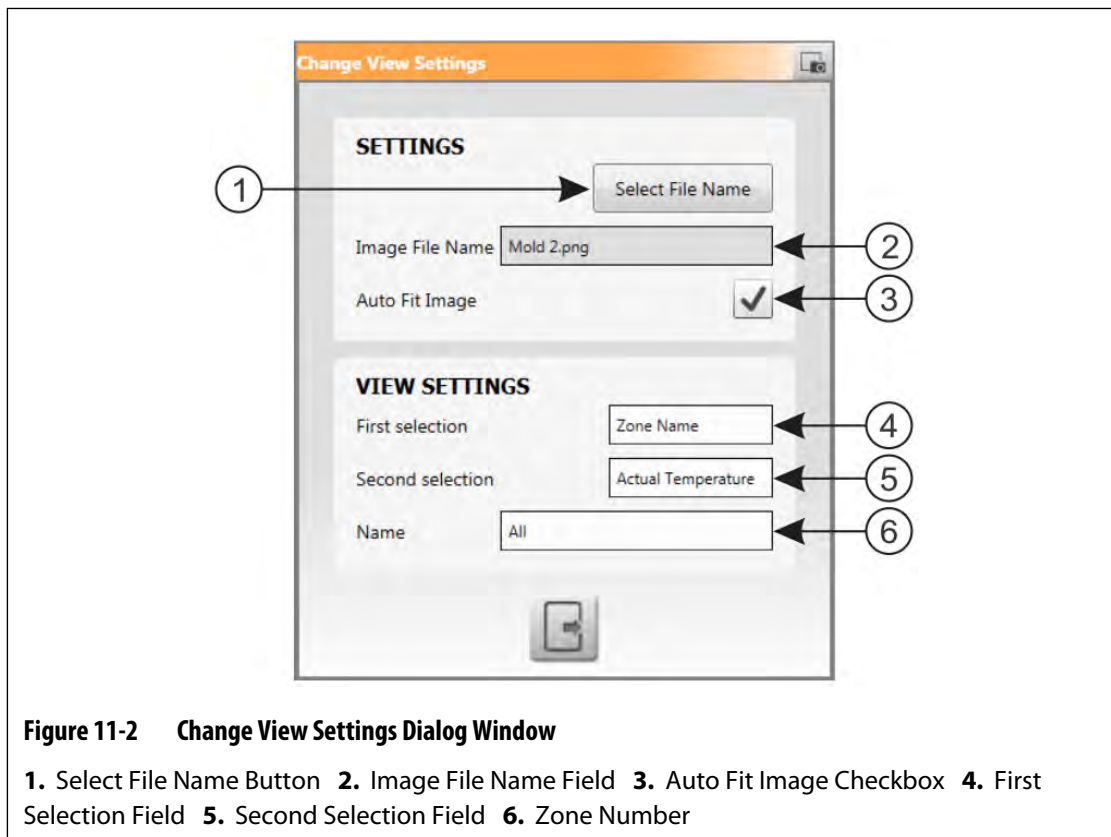


Figure 11-2 Change View Settings Dialog Window

1. Select File Name Button **2.** Image File Name Field **3.** Auto Fit Image Checkbox **4.** First Selection Field **5.** Second Selection Field **6.** Zone Number

- 5.** Touch the **Select File Name** button.
- 6.** Touch one of the file location buttons that follow:
 - **Local** - to navigate to a graphic file stored on the Altanium.
 - **Network** - to navigate to a graphic file stored on a network.
 - **USB** - to navigate to a graphic file stored on a USB drive.
- 7.** Navigate to where the image is stored.
- 8.** Select the image.
- 9.** Touch the **Accept** button.

NOTE: To automatically increase the size of the image to fill the Mold Picture View screen, touch the **Auto Fit Image** checkbox so the check mark shows.
- 10.** Touch the **Accept** button.

11.2 Mold Picture View Toolbar

Use the Mold Picture View toolbar to change the view of the mold picture view graphic. To hide or show the Mold Picture View toolbar, touch the screen.

NOTE: The Mold Picture View toolbar is not available in Edit mode.

The items in the Mold Picture View toolbar are identified in [Figure 11-3](#) and described in [Table 11-1](#).

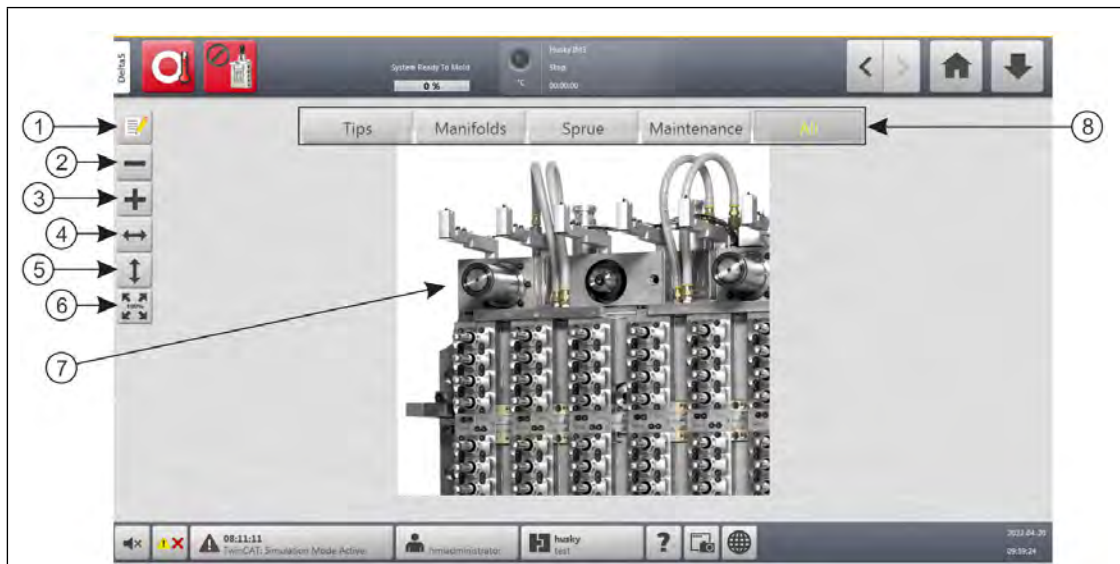


Figure 11-3 Mold Picture View Screen

1. Edit Button 2. Zoom Out Button 3. Zoom In Button 4. Fit Width Button 5. Fit Height Button 6. Original Size Button 7. Mold Picture View Graphic 8. Views

Table 11-1 Mold Picture View Toolbar

Toolbar Button	Definition
Zoom Out Button	Increases the size of the mold picture view graphic.
Zoom In Button	Decreases the size of the mold picture view graphic.
Fit Width Button	Increases or decreases the size of the mold picture view graphic to the widest screen width possible.
Fit Height Button	Increases or decreases the size of the mold picture view graphic to the screen height.
Original Size Button	Increases or decreases the mold picture view graphic to the default size.
Views	Used to select the mold picture view graphic that is related to that view.

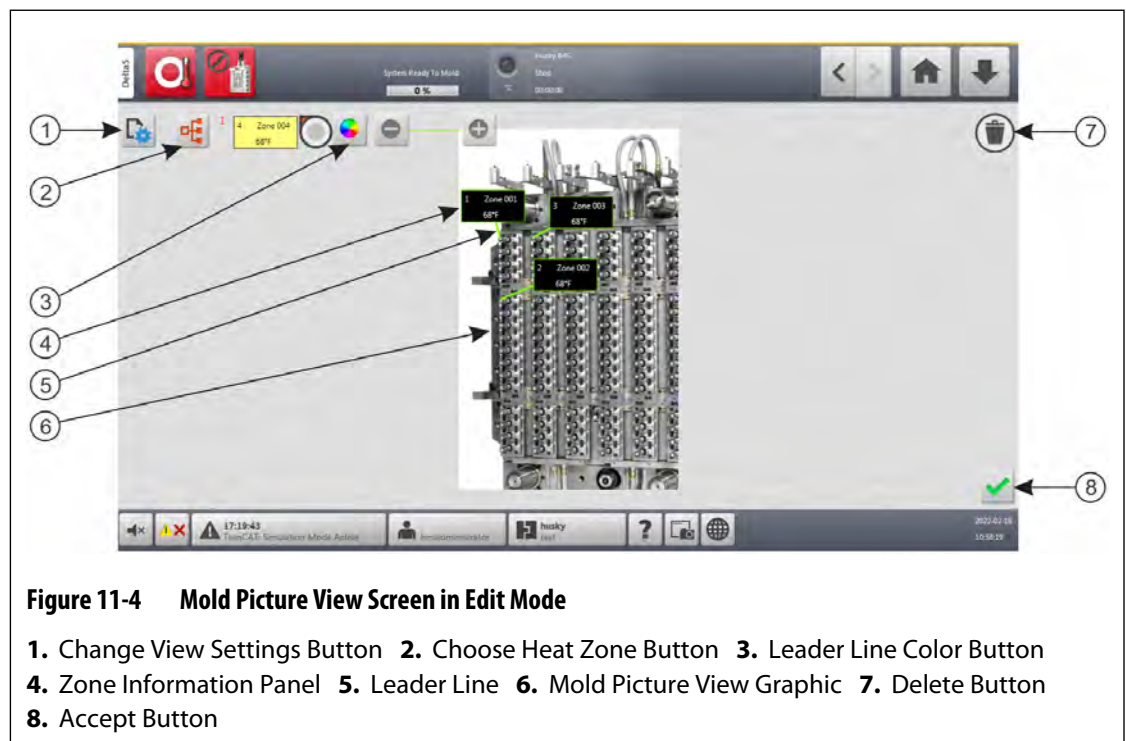
11.3 Configure a Mold Picture View

Configure a Mold Picture View to add zone information panels and leader lines to the loaded mold picture view graphic.

11.3.1 Edit Mode

To configure the Mold Picture View, touch the **Edit** button (refer to [Figure 11-3](#)) to enter Edit mode. [Figure 11-4](#) shows the Edit screen and identifies the items used to configure the mold picture view.

NOTE: To hide or show the Edit toolbar, touch the screen.



11.3.2 Zone Information Panels

You can make zone information panels to identify different parts of the mold graphic. These panels can be put in different positions on the graphic and leader lines from the panels can point to areas of the graphic. The zone information panels always contain a zone number. You can select two other items of information that you want to see in the panel. These are listed in [Section 11.3.2.3](#).

After you configure the zone information panels, other users can see the panels when they select the Mold Picture View from the Home screen. When users touch a zone information panel on the screen, it changes to the Quick Set screen with that zone selected (highlighted).

11.3.2.1 Make a Zone Information Panel

To make a zone information panel, do the steps that follow:

1. Make sure that the Mold Picture View is in Edit mode.
2. Touch the **Choose Heat Zone** button. Refer to [Figure 11-4](#).

The Mold Picture View - Select Zones dialog window shows. Refer to [Figure 11-5](#).

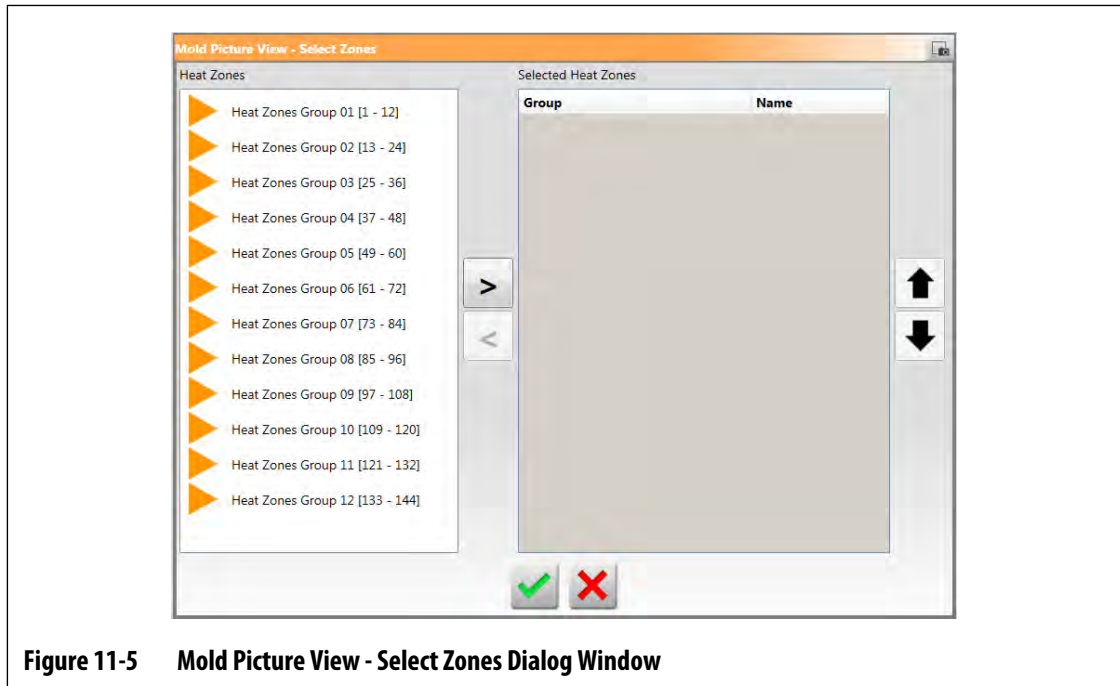


Figure 11-5 Mold Picture View - Select Zones Dialog Window

3. Touch the heat zone(s) to highlight them.
A zone information panel is made for each heat zone selected.
4. Touch the right arrow to move the zone(s) into the right panel.
5. Touch the **Accept** button.

You will see the zone information panels stacked on top of each other at the top of the screen, next to the Choose Heat Zone button.

11.3.2.2 Move a Zone Information Panel

When a zone information panel is made, you select the location where it will show on the mold picture view graphic.

To move a zone information panel, do the steps that follow:

1. Make sure that the Mold Picture View is in Edit mode.
2. On the Mold Picture View screen, touch the zone information panel once to highlight it and then touch and drag the panel to the location you want on the mold picture view graphic.
3. If you made more than one panel, do [step 2](#) again for each one.

11.3.2.3 Edit a Zone Information Panel

In addition to the zone number, a zone information panel also contains two items of information from the list that follows:

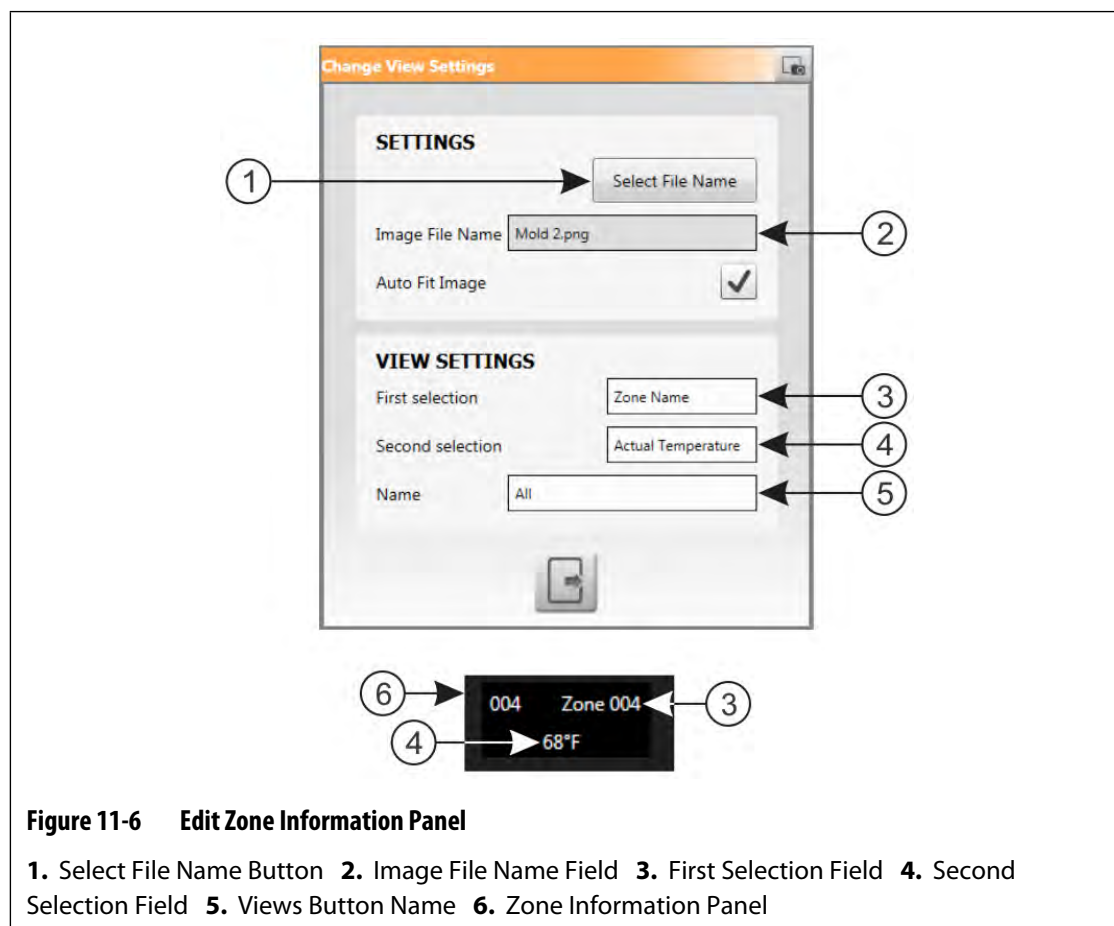
- Zone Name
- Current Temperature Setpoint
- Actual Temperature
- Power Output
- Amperage

NOTE: Actual earth leakage is an option when ICC³ cards are installed, and the Display Earth Leakage Reading is enabled on the System Setup screen.

To change the content displayed on a zone information panel, do the steps that follow:

1. Make sure that the Mold Picture View is in Edit mode.
2. On the Mold Picture View screen, touch the zone information panel to be changed, so it is highlighted.
3. Touch the **Change View Settings** button. Refer to [Figure 11-4](#).

The Change View Settings dialog window shows. Refer to [Figure 11-6](#).



4. To configure the content of the zone information panel, do the steps that follow:
 - To change the first selection displayed on the zone information panel, touch the **First Selection** field, and then select an item.
 - To change the second selection displayed on the zone information panel, touch the **Second Selection** field, and then select an item.
5. Touch the **Exit** button.

11.3.2.4 Make a Leader Line

Make leader lines to show the connection between a zone information panel and the related heat zone on the graphic. Move the panel to a location you want on the graphic before you make a leader line.

To make a leader line, do the steps that follow:

1. Make sure that the Mold Picture View is in Edit mode.
2. Touch a zone information panel that will get the leader line.
3. Touch and drag the **Flag** button to the location you want on the mold picture view graphic.



A leader line shows between the flag and the zone information panel.

11.3.2.5 Change the Color of a Leader Line

To change the color of a leader line, do the steps that follow:

1. Make sure that the Mold Picture View is in Edit mode.
2. Touch to highlight the zone information panel with the leader line to be changed.
3. Touch the **Leader Line Color** button. Refer to [Figure 11-4](#).
4. Touch the color you want.
5. Touch the **Accept** button.

11.3.2.6 Change the Thickness of a Leader Line

To change the color of a leader line, do the steps that follow:

1. Make sure that the Mold Picture View is in Edit mode.
2. Touch to highlight the zone information panel with the leader line to be changed.
3. Touch the **Plus** or **Minus** buttons to change the leader line thickness.



11.3.2.7 Delete a Leader Line

To delete a leader line, do the steps that follow:

1. Make sure that the Mold Picture View is in Edit mode.
2. Touch and drag the leader line to be deleted onto the related zone information panel or off the mold picture view graphic.

11.3.2.8 Delete a Zone Information Panel

To delete a zone information panel, do the steps that follow:

1. Make sure that the Mold Picture View is in Edit mode.
2. Touch and drag the zone information panel to be deleted onto the **Delete** button (refer to [Figure 11-4](#)) or off the mold picture view graphic.
or
3. Select the zone information panel and touch the **Delete** button.

11.3.3 Exit Edit Mode

To exit Edit mode, do the steps that follow:

1. Make sure that the Mold Picture View is in Edit mode.
2. Touch the **Accept** button (green check mark). Refer to [Figure 11-4](#).

Chapter 12 Data Recording

Data recording is used to track the operation of a mold. This tool helps analyze the system to make the molding process better, track errors, find the source of an error, or predict where future errors could occur. The Error Log contains a record of errors that have occurred since the errors were last cleared.

Use the Process Monitoring screens to see the operation of a mold and the recorded data. If an error occurs while the system recorded data, review the data at the time of the error to search for possible causes.

12.1 Trend Plot Screen

The Trend Plot screen shows the information that follows:

- The last 400 samples on four charts, where the X axis is the sample number, and the Y axis is the value of the sampled variable.
- The data available for a selected variable.
- The timestamp and value for a point on a graph.

12.1.1 Set the Trend Plot

To change the zone or process shown on the Trend Plot screen, do the steps that follow:

1. On the Home screen, touch the **Process Monitoring** button.
2. Touch the **Trend Plot** tab.

The Trend Plot screen shows. Refer to [Figure 12-1](#).

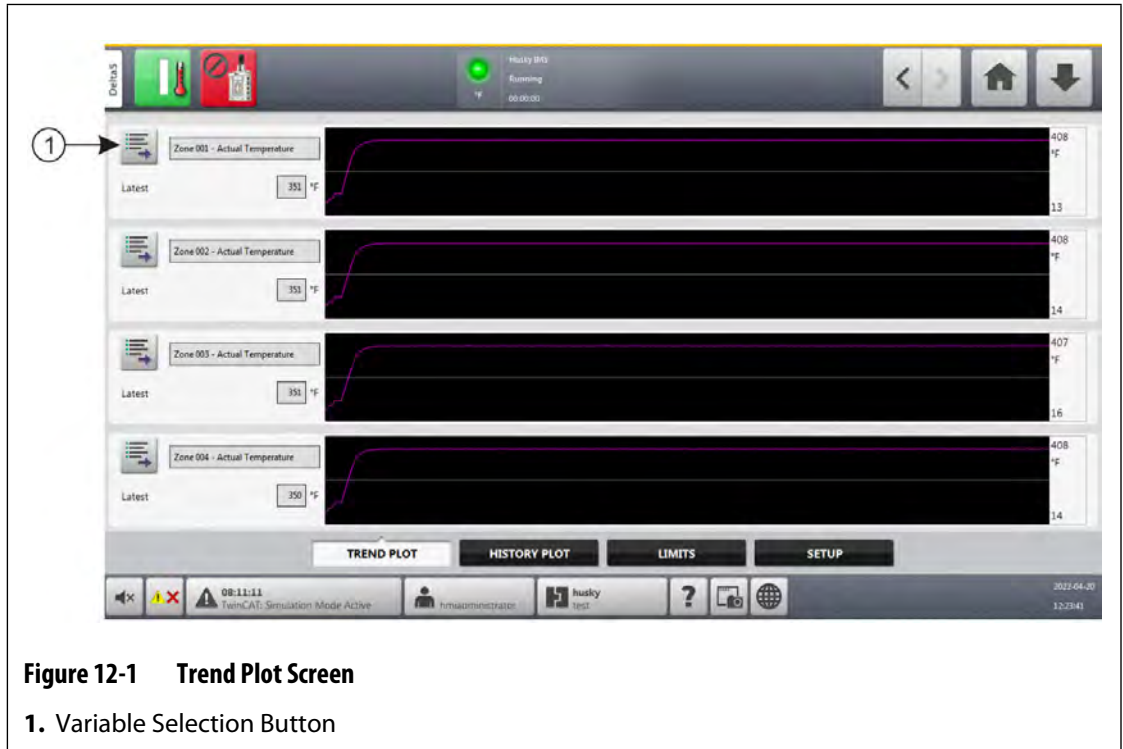


Figure 12-1 Trend Plot Screen

1. Variable Selection Button

3. Touch the **Variable Selection** button.

The Statistical Process Control Details Variable Selector dialog window shows. Refer to Figure 12-2.

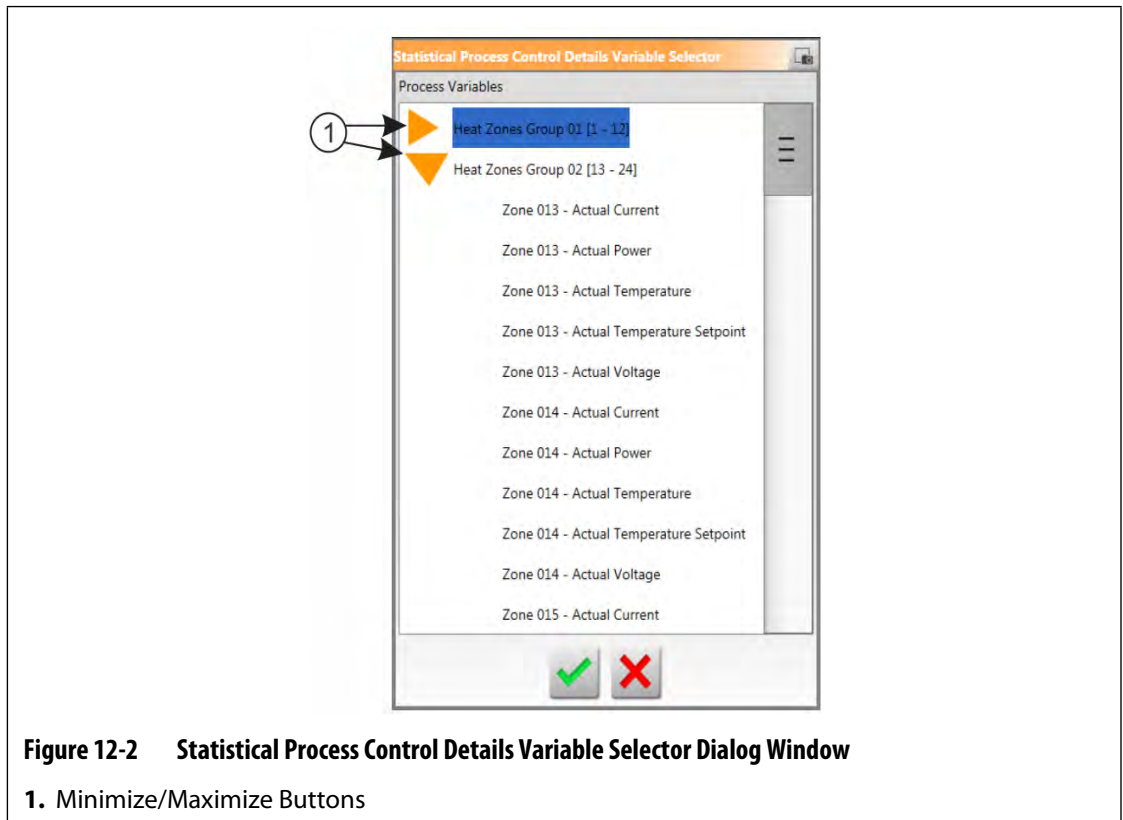


Figure 12-2 Statistical Process Control Details Variable Selector Dialog Window

1. Minimize/Maximize Buttons

4. Touch the **Minimize/Maximize** buttons to navigate to the selection you want.
5. Touch the process variable you want to see.
6. Touch the **Accept** button.

12.2 History Plot Screen

The History Plot screen gives a visual summary of the recorded operation that shows power usage, temperature fluctuations, setpoint values, pressures, positions, and times. A detailed textual representation is offered for specific times. Data is shown zone by zone.

To see the History Plot screen, touch the **Process Monitoring** button on the Home screen and then touch the **History Plot** tab. Refer to [Figure 12-3](#).

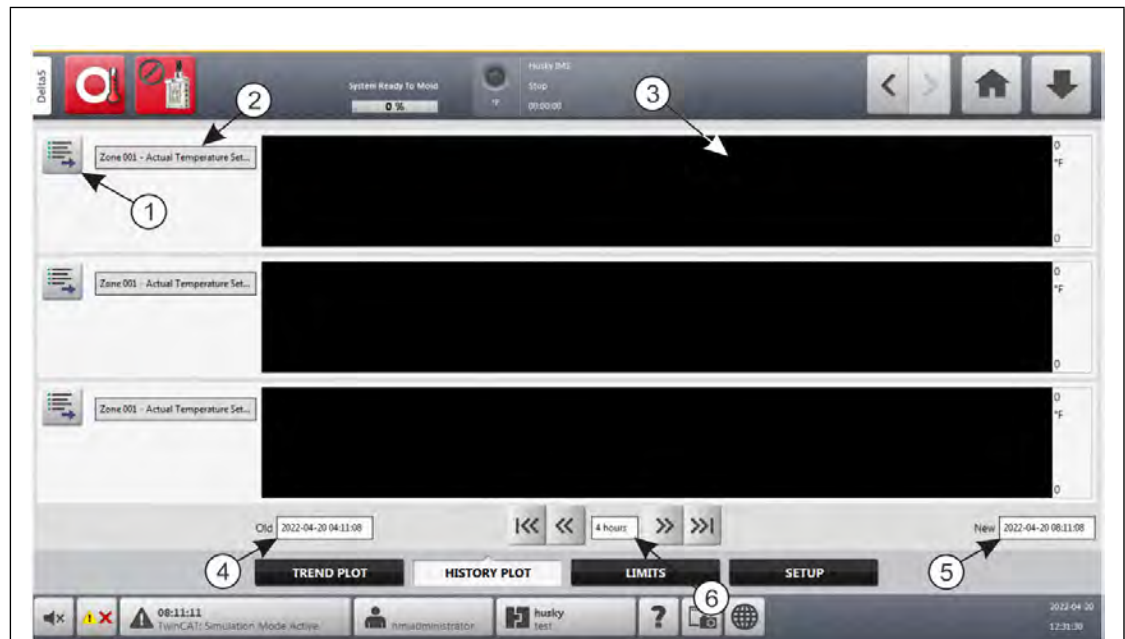


Figure 12-3 History Plot Screen

1. Variable Selection Button
2. Process Variable
3. Graph Section
4. Old Date and Time Range
5. New Date and Time Range
6. Timeframe

Items on the History Plot screen are described in [Table 12-1](#).

Table 12-1 Process History Screen Item Descriptions

Item	Description
Process Variable	The process variable shown in the process history.
Graph Section	The operation history of one zone.
Timeframe	The period of time shown on the graphs.
Date Range Old	The oldest date shown on the graph.
Date Range New	The newest date shown on the graph.

Available process variables for heat zones are:

- Actual Current
- Actual Earth Leakage (shown only when configured in System Setup)
- Actual Power
- Actual Temperature
- Actual Temperature Setpoint
- Actual Voltage

Available process variables for UltraSync-E (if installed) are:

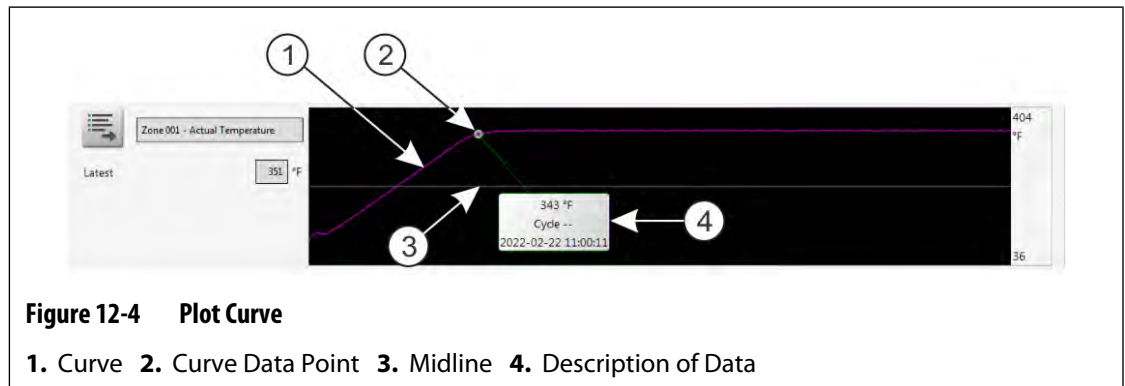
- Close Position
- Closing Duration
- Closing Peak Force
- Motor I2T
- Motor Temperature
- Open Position
- Opening Duration
- Opening Peak Force

The Cycle Time process variable is always available also.

The process history holds 20,000 records. Records contain values for all of the logged values for each zone in the system. A frequent sample rate fills the database faster than a slower sample rate.

12.2.1 Curve Data Point

For a description of the data at a specific point on the graph, touch that location and the description shows in a box. Refer to [Figure 12-4](#).



The curve information is described in [Table 12-2](#).

Table 12-2 Plot Screen Curve Data Descriptions

Screen Element	Description
Curve	Graphical representation of data values.
Curve Data Point	A selected data point value on the curve.

Table 12-2 Plot Screen Curve Data Descriptions (Continued)

Screen Element	Description
Midline	The midline is the middle value of the curve. For example, $(540 + (-90)) / 2 = 225$.
Variable Selection Button	Touch the button next to the process variable name to select a process parameter to see.
Value	X Axis value reflects the value of the parameter selected at a specific moment in time.

12.2.2 Set the Timeframe

You can select a timeframe for the curves in 1-, 2-, 4-, 8-, or 12-hour increments. The default timeframe is 4 hours.

When the timeframe is changed, the system automatically updates the new start date and time range. The old date and time range will not change.

To change the timeframe, do the steps that follow:

1. On the Home screen, touch the **Process Monitoring** button.
2. Touch the **History Plot** tab.
3. On the History Plot screen, touch the **Timeframe** field. Refer to [Figure 12-3](#).
4. Touch a timeframe (1, 2, 4, 8, or 12) to select it.

12.2.3 Set the Date and Time Range

You can select a date range for the curves. The default Old date is the New date value minus the Timeframe value. The default end date is the current date and time.

The Old and New date and time range fields are identified in [Figure 12-3](#).

12.2.3.1 Change the Date and Time Range Old

Touch the **Old** date and time range field, enter the date and time in the Old dialog window that shows, and then touch the **Accept** button.

If the calculated Date Range End value is later than the current system time, the Old Date value is adjusted automatically to maintain the Timeframe value.

12.2.3.2 Change the Date and Time Range New

Touch the **New** date and time range field, enter the date and time in the New dialog window that shows, and then touch the **Accept** button.

The New date and time range change automatically updates the Old date and time range by the current timeframe duration.

NOTE: The date and time cannot be changed to a value later than the current system time.

12.2.4 Change the Zone Shown on the History Plot Screen

To change a zone shown on the History Plot screen, do the steps that follow:

1. On the History Plot screen, touch the **Variable Selection** button of the zone or process to be changed. Refer to [Figure 12-3](#).

The Process History Variable Selector dialog window shows. Refer to [Figure 12-5](#).

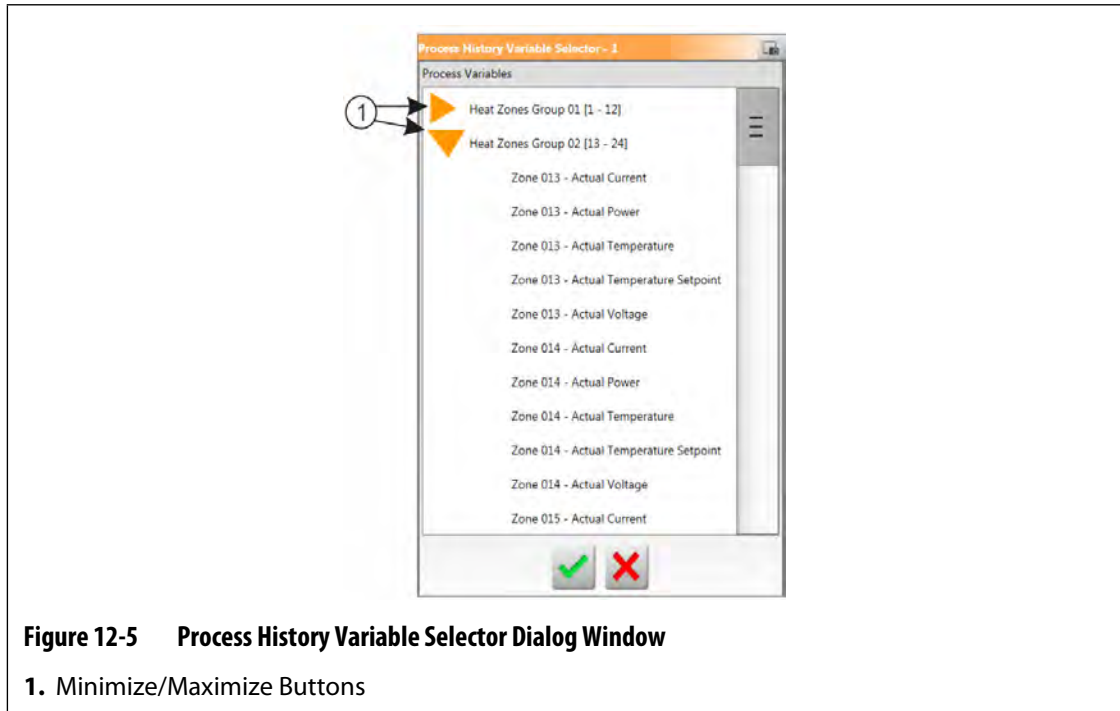


Figure 12-5 Process History Variable Selector Dialog Window

1. Minimize/Maximize Buttons
2. Touch the **Minimize/Maximize** buttons to navigate to the selection you want.
3. Touch the heat zone or process you want to see.
4. Touch the **Accept** button.

12.3 Process Limits Screen

Use the process Limits screen to set up the specification limits for each variable. When a variable value is outside the lower or upper limits, the variable is considered out of specification and triggers an alarm, a digital output, and/or the controller may stop.

To access the process Limits screen, do the steps that follow:

1. On the Home screen, touch the **Process Monitoring** button.
2. Touch the **Limits** tab at the bottom of the screen.

The process Limits screen shows. Refer to [Figure 12-6](#). Because of the size of the screen, some settings are not seen in the figure. Refer to [Figure 12-7](#) to see all of the screen settings.



Figure 12-6 Process Limits Screen



Figure 12-7 Target and Global Settings

The process Limits screen settings and information fields are described in [Table 12-3](#).

Table 12-3 Process Limits Screen Fields

Limit	Definition
Use Limits	Select the Use Limits checkbox and the Altanium controller will trigger an alarm if the process variable is not in the lower and upper limits.
Critical	The controller could stop if the process variable is not in the lower and upper limits. To do this action, select the Process Outside Limit checkbox.
Threshold Limit	The number of times that the value must be outside of the lower and upper limit before there is an alarm or the system stops. The action is configured in the Global Settings panel of the screen.
Lower Limit	The lowest value the process variable value can be at before there is an “out of specification” alarm or the system stops. The action is configured in the Global Settings panel of the screen.
Upper Limit	The highest value the process variable value can be at before there is an “out of specification” alarm or the system stops. The action is configured in the Global Settings panel of the screen.

Table 12-3 Process Limits Screen Fields (Continued)

Limit	Definition
Process Outside Limit	When enabled, this activates the Process Outside Limit (Digital Output 6) signal when one or more of the process variables goes out of specification limits. This output is found in the I/O settings screen.
Critical Variable Action - Heats	With the Critical checkbox enabled, this sets the action for the heats when a process variable goes out of specification. This parameter is only shown when the controller is configured with heats.
Critical Variable Action - Servos	With the Critical checkbox enabled, this sets the action for the servos when a process variable goes out of specification. This parameter is only shown when the controller is configured with UltraSync-E and/or Mold Servo Control.
Delay Limit Check - Heats Limit	Sets the amount of time the controller waits while At-Temperature before the system starts a check of the specification limits.
Delay Limit Check - Servos Limit	Sets the number of cycles in Engaged mode that the controller must complete before the system starts a check of the specification limits.
Limit Check Active	This is illuminated when the system does the Limit Check operation of the heats and servos.
Process Variable Selector	Touch this button to select the process variable groups you want to see on the process Limits screen.

12.3.1 Target Settings

Use the Target Settings fields of the screen to enable and configure the zone limit ranges for:

- Current
- Power
- Temperature
- Voltage

To configure the Target Settings for one or more zones, do the steps that follow:

1. On the process Limits screen, touch to highlight one or more zones you want to set.

NOTE: If you select more than one zone, select them by the same category (Current, Power, Temperature, or Voltage) if they are to be in the same limits.

2. Touch the **Lower Limit** field, enter the setting for the category measurement (amps, percentage, degrees, or volts), and then touch the **Accept** button.
3. Touch the **Upper Limit** field, enter the setting for the category measurement (amps, percentage, degrees, or volts) and then touch the **Accept** button.
4. Touch the **Threshold** field and enter the number of times that a value must be outside of the lower and upper limit before Out of Specification Action starts.
5. Touch the **Accept** button.
6. To enable the Target Settings, touch the **Use Limits** field and select **Yes**.

7. If you want to set these Target Settings critical, touch the **Critical** field and select **Yes**.
8. If you want to activate the Process Outside Limit (Digital Output 6) signal during an out of limit condition, touch the **Process Outside Limits** checkbox, so the check mark shows.

12.3.2 Global Settings

In the Global Settings panel, you can set a Critical Variable Action for the heats and/or servos that are installed on your system. For heats, the selections are No Reaction or Stop Heats. For servos, the selections are No Reaction or Stop End of Cycle.

To set a Critical Variable Action, do the steps that follow:

1. On the process Limits screen, touch the **Heats** or **Servos** field.
2. Select the action you want for the heats or servos.

12.3.3 Delay Limit Check

If you want the Altanium controller to wait a specified time or number of cycles before the system does the limit check, those parameters can be set in the Delay Limit Check panel.

To set the heats parameter, do the steps that follow:

1. On the process Limits screen, touch the **Heats Time Delay Limit** field and enter the number of seconds for the delay (1 to 900 seconds).
2. Touch the **Accept** button.

To set the servos parameter, do the steps that follow:

1. On the process Limits screen, touch the **Servo Cycle Delay** field and enter the number of cycles for the delay (1 to 999 cycles).
2. Touch the **Accept** button.

12.3.4 Process Variable Selector

If you want to filter what you see listed on the process Limits screen, you can use the Process Variable Selector. This lets you select one or more zone groups, Process Monitoring, and/or servos (such as UltraSync-E).

To filter what is shown on the process Limits screen, do the following:

1. On the process Limits screen, touch the **Process Variable Selector** button.



The Process Variable Selector dialog window shows. Refer to [Figure 12-8](#).

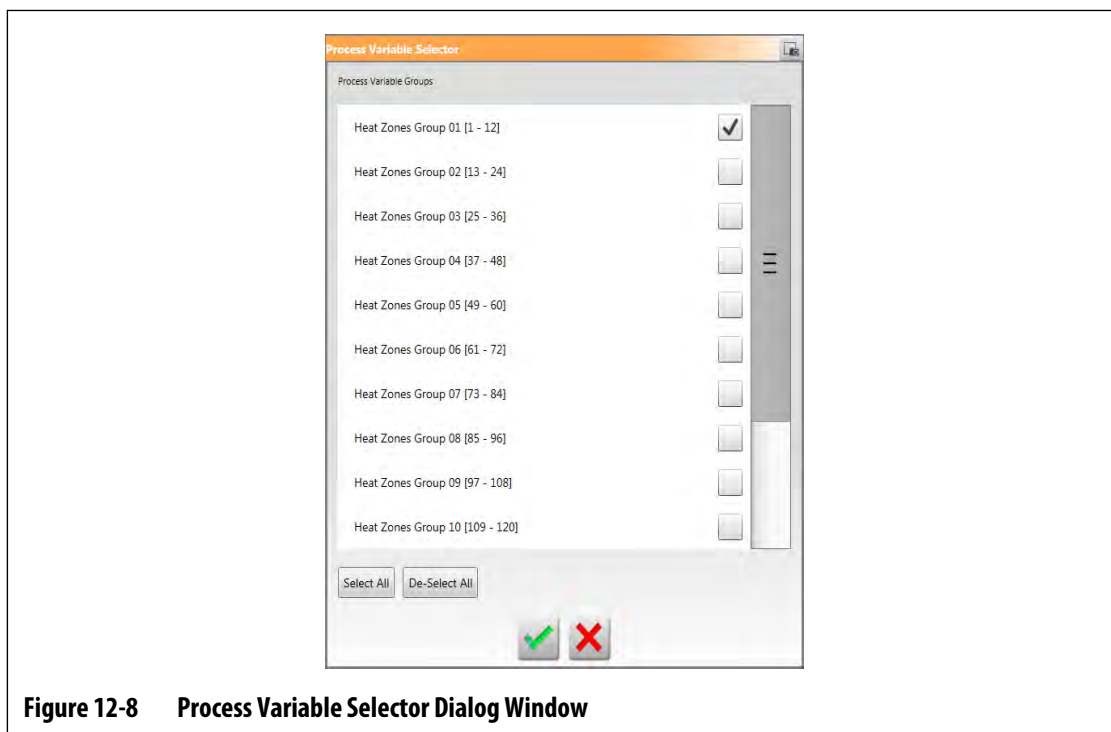
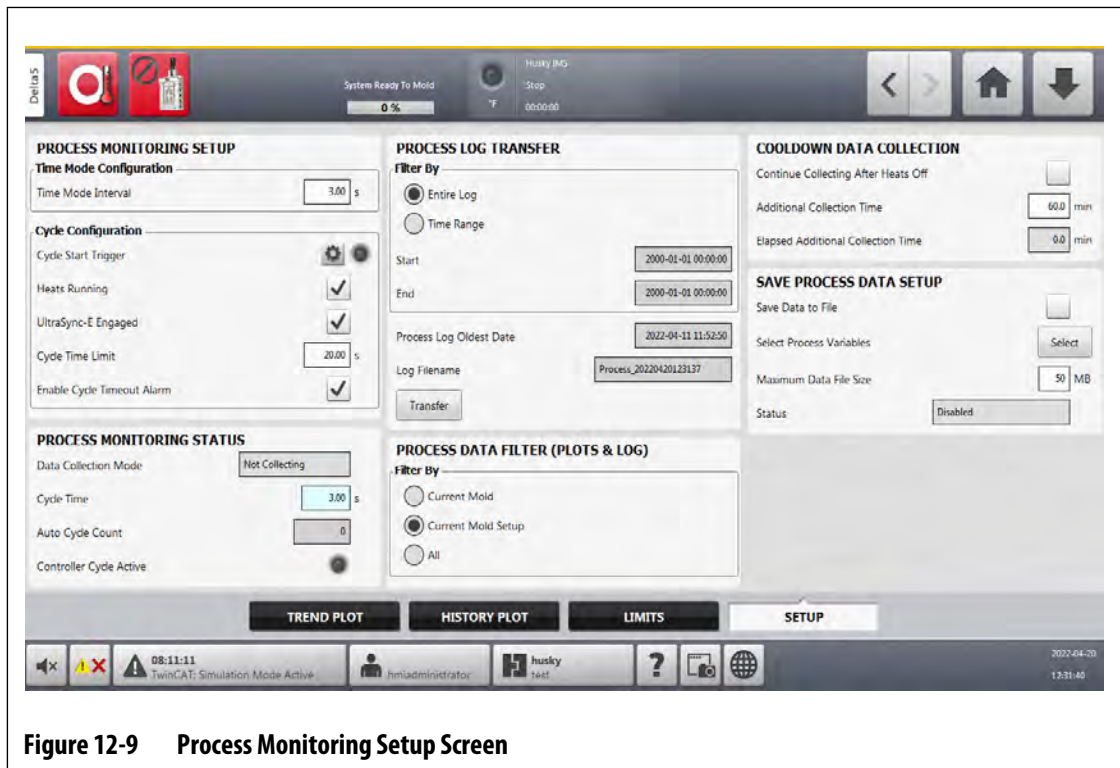


Figure 12-8 Process Variable Selector Dialog Window

2. Touch the checkboxes of the items you want to see on the process Limits screen, so check marks are shown for those items.
3. Touch the **Accept** button.

12.4 Process Monitoring Setup

On the process monitoring Setup screen, you can set the system to record data in a time mode interval or with a cycle mode start configuration. Cool down data collection can also be enabled from this screen. To see the process monitoring Setup screen, touch the **Process Monitoring** button on the Home screen and then the **Setup** tab. Refer to [Figure 12-9](#).



12.4.1 Time Mode Configuration

Time mode is used in operations when data collection is not cycle dependent and data must be collected at a timed interval. You can set how often process data is sampled. The value can be set from 2 to 300 seconds. The default time is 3 seconds.

During data collection, the selected data is sampled at approximately the same time. The zones do not have to be At Temperature.

NOTE: Time mode data collection is not done when the heats controller is in Stop, ART, Calibration, or Diagnostics modes.

To set the time mode interval, do the steps the follow:

1. From the Home screen, touch the **Process Monitoring** button.
2. Touch the **Setup** tab.
3. Touch the **Time Mode Interval** field.
4. Type the number of seconds in which the data must be sample and then touch the **Accept** button.

12.4.2 Cool Down Data Collection

You can continue data collection for an interval of time after the controller has stopped. In the Cooldown Data Collection panel of the process Limits screen, you can set a time value from 1 to 180 minutes. The default value is 60 minutes. When the timer expires, the data collection stops.

NOTE: Cool down data collection is only available if the controller is configured with temperature control. This feature will only work when the controller changes from the Running, Standby, or Boost state to the Stop state.

To set and enable the cool down data collection timer, do the steps that follow:

1. From the Home screen, touch the **Process Monitoring** button.
2. Touch the **Setup** tab.
3. Touch the **Additional Collection Time** field and type the time you want the controller to continue its data collection after the controller has stopped.
4. Touch the **Accept** button.
5. Touch the **Continue Collecting After Heats Off** checkbox, so the check mark shows.

12.4.3 Cycle Mode Configuration

You can set the Altanium system to cycle mode data collection. Data collection starts at the rising edge of the selected cycle start signal. The time mode data collection stops.

To use the cycle mode configuration, the Altanium controller must have heats installed with one of the control technologies that follow:

- UltraSync-E
- Altanium Servo Controller
- UltraShot
- Altanium Valve Gate Sequencer

The cycle mode configuration can also be used when the Cycle Input signal is selected for use when the Altanium controller is configured for heats only.

The data collection can be set to start by the signals that follow:

- IMM in Auto
- External At Temperature
- UltraSync-E Stems Open Command
- UltraSync-E Stems Closed Command
- External Permit Calibration
- Servo Digital Input 6 - 10
- Configurable Signal 1 - 18
- Cycle Input (refer to [Section 12.4.3.3](#))

To set the cycle mode configuration, do the steps that follow:

1. From the Home screen, touch the **Process Monitoring** button.
2. Touch the **Setup** tab.

3. Touch the **Cycle Start Trigger** gear button. The Configure Signal dialog window shows (refer to Figure 12-10).

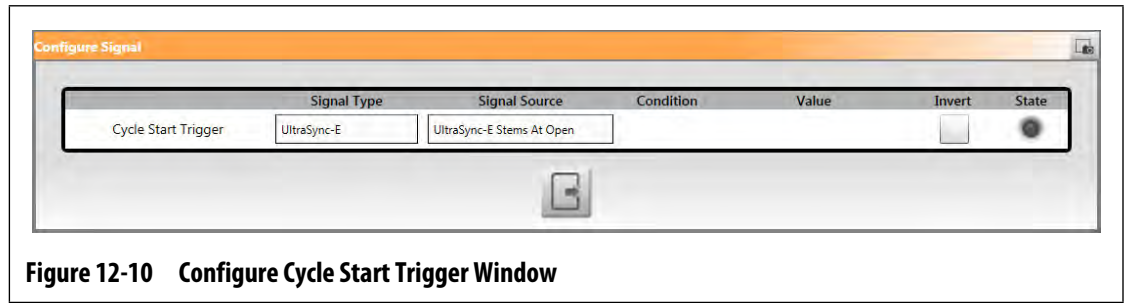


Figure 12-10 Configure Cycle Start Trigger Window

4. Select the signal type and related source, condition, and value to configure a start signal.
5. Touch the **Heats Running** checkbox, so the check mark shows, if applicable.
6. Touch the servo control system **Engaged** checkbox, so the check mark shows, if applicable.

For example, if UltraSync-E is installed on your system, it will show as **UltraSync-E Engaged**.

12.4.3.1 Data Collection Start Conditions

Table 12-4 shows the data collection start conditions with specified operations enabled and disabled.

Table 12-4 Cycle Mode - Conditions to Start (UltraSync-E or Altanium Servo Control Installed)

Heats Running Condition Enabled	UltraSync-E Engaged Condition Enabled	Mold Servo Controller Engaged Condition Enabled	Cycle Mode Conditions Selection Shown on Screen	Conditions to Start
Yes	Yes	No	Yes	Start signal goes High AND heats are turned On and At Temperature AND UltraSync-E is engaged
Yes	No	Yes	Yes	Start signal goes high AND heats are turned on and At Temperature AND Mold Servo Controller is engaged
Yes	Yes	Yes	Yes	Start signal goes high AND heats are turned on and are At Temperature AND UltraSync-E is engaged AND Mold Servo Controller is engaged
No	Yes	No	No	Start signal goes high AND UltraSync-E is engaged
No	No	Yes	No	Start signal goes high AND mold servo controller is engaged

Table 12-4 Cycle Mode - Conditions to Start (UltraSync-E or Altanium Servo Control Installed) (Continued)

Heats Running Condition Enabled	UltraSync-E Engaged Condition Enabled	Mold Servo Controller Engaged Condition Enabled	Cycle Mode Conditions Selection Shown on Screen	Conditions to Start
No	Yes	Yes	Yes	Start signal goes high AND UltraSync-E is engaged AND Mold Servo Controller is engaged
Yes	No	No	Yes	Not permitted

12.4.3.2 Data Collection Stop Conditions

Table 12-5 shows the data collection stop conditions with specified operations enabled and disabled.

Table 12-5 Cycle Mode - Conditions to Stop (UltraSync-E or Altanium Servo Control Installed)

Heats Running Condition Enabled	UltraSync-E Engaged Condition Enabled	Mold Servo Controller Engaged Condition Enabled	Cycle Mode Conditions Selection Shown on Screen	Conditions to Stop
Yes	Yes	No	Yes	<p>If pair of digital inputs (start and end)</p> <ul style="list-style-type: none"> • End digital input does not go high before the cycle time limit has expired • Heats are turned off or not At Temperature • UltraSync-E is disengaged or disabled <p>System changes to timed data collection</p> <hr/> <p>If one digital input to start and timer to end data collection:</p> <ul style="list-style-type: none"> • Start digital input is not high again before the cycle time limit has expired • Heats are turned off or not At Temperature • UltraSync-E is disengaged or disabled <p>System changes to timed data collection</p> <hr/> <p>If one digital input to start and end data collection:</p> <ul style="list-style-type: none"> • Start digital input does not go high again before the cycle time limit has expired • Heats are turned off or not At Temperature • UltraSync-E is disengaged or disabled <p>System changes to timed data collection</p>

Table 12-5 Cycle Mode - Conditions to Stop (UltraSync-E or Altanium Servo Control Installed) (Continued)

Heats Running Condition Enabled	UltraSync-E Engaged Condition Enabled	Mold Servo Controller Engaged Condition Enabled	Cycle Mode Conditions Selection Shown on Screen	Conditions to Stop
Yes	No	Yes	Yes	<p>If pair of digital inputs (start and end):</p> <ul style="list-style-type: none"> • End digital input does not go high before the cycle time limit has expired • Heats are turned off or not At Temperature • Mold Servo Controller is disengaged or disabled <p>System changes to timed data collection</p> <hr/> <p>If one digital input to start and timer to end data acquisition:</p> <ul style="list-style-type: none"> • Start digital input is not high again before the cycle time limit has expired • Heats are turned off or not At Temperature • Mold Servo Controller is disengaged or disabled <p>System changes to timed data collection</p> <hr/> <p>If one digital input to start and end data acquisition:</p> <ul style="list-style-type: none"> • Start digital input does not go high again before the cycle time limit has expired • Heats are turned off or not At Temperature • Mold Servo Controller is disengaged or disabled <p>System changes to timed data collection</p>

Table 12-5 Cycle Mode - Conditions to Stop (UltraSync-E or Altanium Servo Control Installed) (Continued)

Heats Running Condition Enabled	UltraSync-E Engaged Condition Enabled	Mold Servo Controller Engaged Condition Enabled	Cycle Mode Conditions Selection Shown on Screen	Conditions to Stop
Yes	Yes	Yes	Yes	<p>If pair of digital inputs (start and end):</p> <ul style="list-style-type: none"> • End digital input does not go high before the cycle time limit has expired • Heats are turned off or not At Temperature • UltraSync-E is disengaged or disabled • Mold Servo Controller is disengaged or disabled <p>System changes to timed data collection</p> <hr/> <p>If one digital input to start and timer to end data acquisition:</p> <ul style="list-style-type: none"> • Start digital input is not high again before the cycle time limit has expired • Heats are turned off or not At Temperature • UltraSync-E is disengaged or disabled • Mold Servo Controller is disengaged or disabled <p>System changes to timed data collection</p> <hr/> <p>If one digital input to start and end data acquisition:</p> <ul style="list-style-type: none"> • Start digital input does not go high again before the cycle time limit has expired • Heats are turned off or not At Temperature • UltraSync-E is disengaged or disabled • Mold Servo Controller is disengaged or disabled <p>System changes to timed data collection</p>

Table 12-5 Cycle Mode - Conditions to Stop (UltraSync-E or Altanium Servo Control Installed) (Continued)

Heats Running Condition Enabled	UltraSync-E Engaged Condition Enabled	Mold Servo Controller Engaged Condition Enabled	Cycle Mode Conditions Selection Shown on Screen	Conditions to Stop
No	Yes	No	No	<p>If pair of digital inputs (start and end):</p> <ul style="list-style-type: none"> • End digital input does not go high before the cycle time limit has expired • UltraSync-E is disengaged or disabled <p>System does not change to timed data collection</p> <hr/> <p>If one digital input to start and timer to stop data acquisition:</p> <ul style="list-style-type: none"> • Start digital input is not high again before the cycle time limit has expired • UltraSync-E is disengaged or disabled <p>System does not change to timed data collection</p> <hr/> <p>If one digital input to start and end data acquisition:</p> <ul style="list-style-type: none"> • Start digital input does not go high again before the cycle time limit has expired • UltraSync-E is disengaged or disabled <p>System does not change to timed data collection</p>

Table 12-5 Cycle Mode - Conditions to Stop (UltraSync-E or Altanium Servo Control Installed) (Continued)

Heats Running Condition Enabled	UltraSync-E Engaged Condition Enabled	Mold Servo Controller Engaged Condition Enabled	Cycle Mode Conditions Selection Shown on Screen	Conditions to Stop
No	No	Yes	No	<p>If pair of digital inputs (start and end):</p> <ul style="list-style-type: none"> • End digital input does not go high before the cycle time limit has expired • Mold Servo Controller is disengaged or disabled <p>System does not change to timed data collection</p> <hr/> <p>If one digital input to start and timer to end data acquisition:</p> <ul style="list-style-type: none"> • Start digital input is not high again before the cycle time limit has expired • Mold Servo Controller is disengaged or disabled <p>System does not change to timed data collection</p> <hr/> <p>If one digital input to start and end data acquisition:</p> <ul style="list-style-type: none"> • Start digital input does not go high again before the cycle time limit has expired • Mold Servo Controller is disengaged or disabled <p>System does not change to timed data collection</p>

Table 12-5 Cycle Mode - Conditions to Stop (UltraSync-E or Altanium Servo Control Installed) (Continued)

Heats Running Condition Enabled	UltraSync-E Engaged Condition Enabled	Mold Servo Controller Engaged Condition Enabled	Cycle Mode Conditions Selection Shown on Screen	Conditions to Stop
No	Yes	Yes	Yes	<p>If pair of digital inputs (start and end):</p> <ul style="list-style-type: none"> • End digital input does not go high before the cycle time limit has expired • UltraSync-E is disengaged or disabled • Mold Servo Controller is disengaged or disabled <p>System does not change to timed data collection</p> <hr/> <p>If one digital input to start and timer to end data acquisition:</p> <ul style="list-style-type: none"> • Start digital input is not high again before the cycle time limit has expired • UltraSync-E is disengaged or disabled • Mold Servo Controller is disengaged or disabled <p>System does not change to timed data collection</p> <hr/> <p>If one digital input to start and end data acquisition:</p> <ul style="list-style-type: none"> • Start digital input does not go high again before the cycle time limit has expired • UltraSync-E is disengaged or disabled • Mold Servo Controller is disengaged or disabled <p>System does not change to timed data collection</p>
Yes	No	No	Yes	Not applicable

12.4.3.3 Cycle Input (Heat Control Only)

Cycle Input supplies a start or end of cycle signal from the injection molding machine. This input can be configured as the trigger to log process data on Altanium systems configured for heats control only.

When this input is selected for use, the controller looks for a rising edge to trigger the start or end of a cycle.

NOTE: This should be connected to a cyclical signal (the signal goes HIGH to LOW during each injection cycle)

This feature can be enabled or disabled when you select or deselect the 'In Use' checkbox in the Cycle Input line on the Heats Page 1 tab of the Digital Inputs screen. Refer to [Section 14.3](#).

12.4.4 Process Monitoring Status

The process monitoring Setup screen lets you see the controller's monitoring status. In the Process Monitoring Status panel of the screen, the information that follows is shown:

- Data Collection Mode - shows the "Collecting" or "Not Collecting" status
- Cycle Time - shows the actual cycle time for the data collection
- Controller Cycle Active - an indicator that shows the cycle operation is active

12.4.5 Process Log Transfer

The Process Log Transfer panel of the monitoring Setup screen lets you select the quantity of saved data and where to save it. You can select to save the Entire Log or by a Time Range. If you select the Time Range option, the Starts and Stop time field are available for you to set those values.

The Process Log Oldest Date and Log Filename fields are shown for information only.

Touch the **Transfer** button to navigate to the location where the Process Log is stored.

12.4.6 Process Data Filter

The Process Data Filter lets you filter which process variables are shown on the Trend and History Plot screens and saved in the Process Log. The selections are:

- Current Mold
- Current Mold Setup
- All (available data)

The default is the Current Mold Setup (when the controller is first started).

12.4.7 Save Process Data Setup

With the use of the Save Process Data Setup panel on the Setup tab of the Process Monitoring screen, you can configure the Delta5 to save a process data file to a shared network directory. Refer to [Figure 12-11](#).

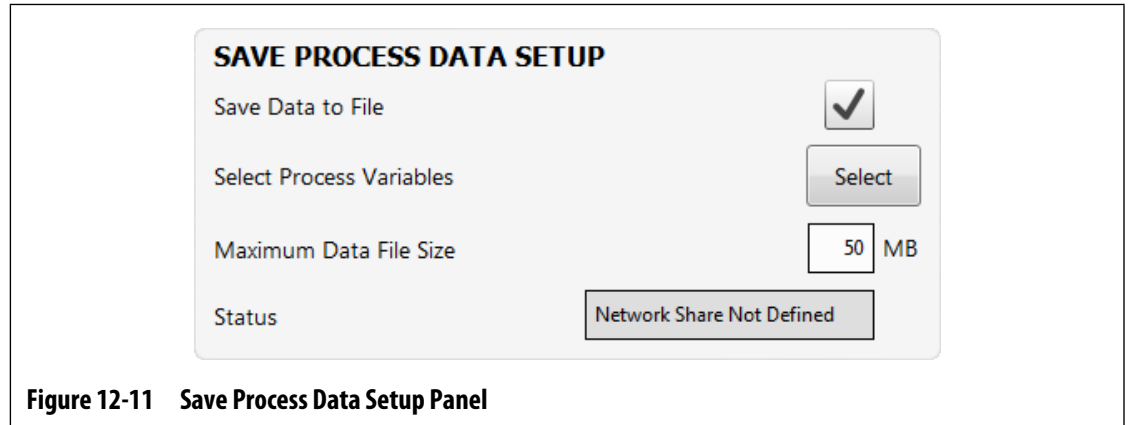


Figure 12-11 Save Process Data Setup Panel

To save a process data file to a shared network directory, do the steps that follow:

1. From the Home screen, touch the **Process Monitoring** button.
2. Touch the **Setup** tab.
NOTE: If the Status field in the Save Process Data Setup panel shows "Network Share Not Defined" (as shown in [Figure 12-11](#)), you must do the steps to connect the controller to a network drive. Refer to [Section 10.2.3](#).
3. In the Save Process Data Setup panel, touch the **Select** button that is next to Select Process Variables.

The Save Process Variables window shows (refer to [Figure 12-12](#)).

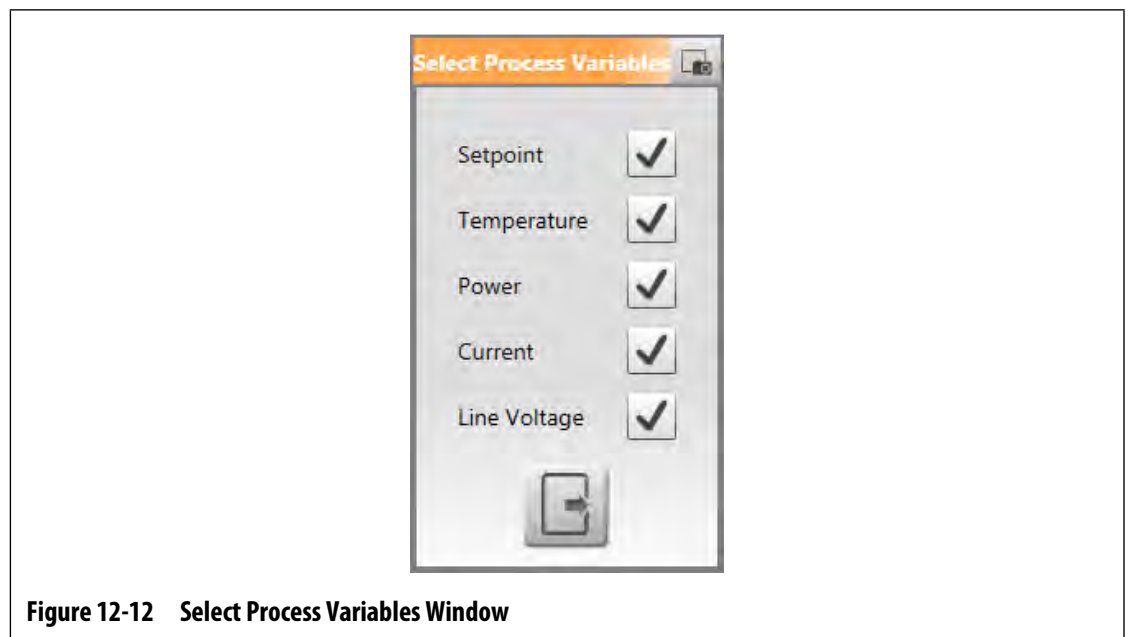


Figure 12-12 Select Process Variables Window

4. Put a check mark next to the process variables that you want to save.
5. Touch the **Exit** button to close the list window.

6. To limit the size of the file, touch the field that is next to the Maximum Data File Size.
7. On the keypad that opens, enter the maximum size of the data file.
8. Touch the green check mark to accept your entry.
9. To enable the process data storage, touch the **Save Data to File** checkbox, so the check mark shows.

Chapter 13 Color Change

Injection mold companies are sometimes required to make many of the same parts in different colors to satisfy customer demands. This is especially prevalent in consumer electronics and packaging markets. This has an impact on injection mold production where fast color change is important.

Husky and Chem-Trend have worked together to create a process using Chem-Trend's Ultra Purge purging compounds that is designed specifically to reduce color-change time and carbon formation in hot runners. Step-by-step instructions were created for Husky's Altanium controllers that outline a simple color-change process explicitly for molds with hot runner systems.

Faster color changes are achieved by making sure the process is followed and all steps are done in the correct order. Results have been up to 85% reduction in scrap and an 80% increase in mold-cleaning efficiency.

The Ultra-Purge usage amount is calculated by multiplying the shot weight by the Ultra-Purge conversion ratio. You enter the values, and the Altanium controller calculates and stores the usage amount. The usage amount is what you reference for measuring and adding the correct quantity of Ultra-Purge compound to the hopper of the injection molding machine.

A cycle-count input determines the correct amount of Ultra-Purge compound by subtracting the shot weight from the usage-amount setting after each cycle. Values are calculated and stored by the controller, with the cycle-count input from the machine. The controller uses this data to alert the operator when the purge compound usage amount is achieved, so the next step can be started.

Combining the technologies of Chem-Trend's Ultra Purge and Husky's Altanium controllers offers a more integrated approach to the color change and mold cleaning that makes sure users follow the optimal process steps that result in fewer mistakes and fast, efficient color changes with a minimal amount of material waste.

This chapter describes the Ultra Purge/Altanium controller process sequences.

13.1 Color Change Screen

With the Color Change feature installed on the Delta5 controller, the Color Change button shows in the Temperature Control panel of the Home screen (refer to Figure 13-1).

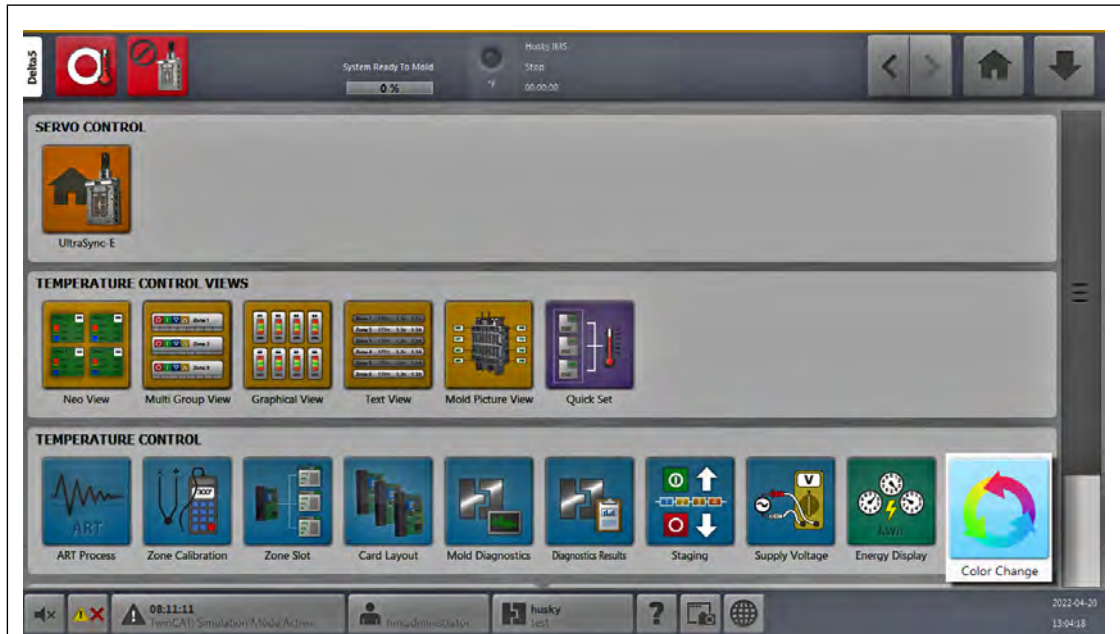


Figure 13-1 Color Change Button on the Delta5 Home Screen

Touch the **Color Change** button on the Delta5 Home screen to see the Color Change screen (refer to Figure 13-2).

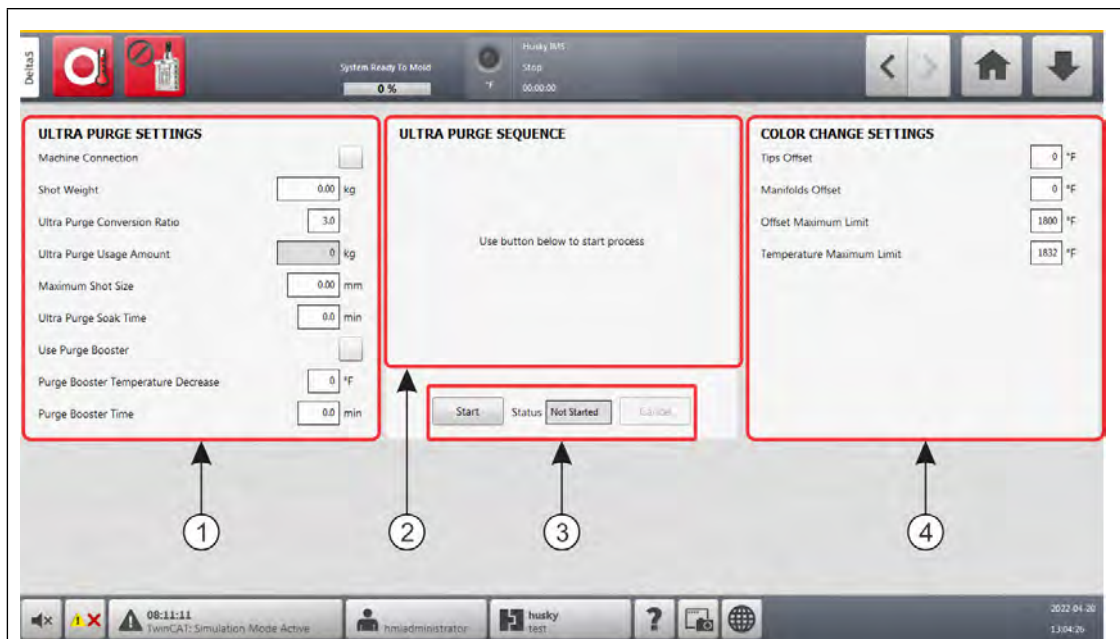


Figure 13-2 Color Change Screen

1. Ultra Purge Settings Panel
2. Ultra Purge Sequence panel
3. Ultra Purge Mode Buttons and Status
4. Color Change Settings Panel

13.1.1 Ultra Purge Settings Panel

The Ultra Purge Settings panel has the user-configurable settings based on the specific needs of the process with Ultra Purge recommendations. [Table 13-1](#) gives the descriptions for the items in the panel.

NOTE: For easy recall and to make sure the specific process is being applied to the correct mold, the settings in the panel are saved to the mold setup file that is loaded at the time the color change feature is being configured.

Table 13-1 Ultra Purge Settings Descriptions

Item	Description
Machine Connection	This enables the cycle input signal used to count injection shots if the Altanium controller and machine are configured for this connection.
Shot Weight	This value defines the shot weight of the part being molded.
Ultra Purge Conversion Ratio	This value is used to calculate the Ultra Purge usage amount.
Ultra Purge Usage Amounts	This value is automatically calculated by the controller by multiplying the shot weight by the conversion ratio.
Maximum Shot Size	This value defines the maximum shot size of the machine.
Ultra Purge Soak Time	This value defines the amount of time the Ultra Purge compound will soak once it has filled the hot runner. This is required before loading the new resin.
Use Purge Booster	This enables the purge booster feature. The purge booster reduces the normal temperature setpoint of the hot runner system to allow a skin to form in the hot runner that allows better cleaning of carbon deposits for some thermally sensitive resins.
Purge Booster Temperature Decrease	This value defines the temperature to be decremented from the normal processing setpoint when using the purge booster feature.
Purge Booster Time	This value defines the amount of time the purge booster will apply the lower temperature.

13.1.2 Ultra Purge Sequence Panel

This field shows each step of the color change sequence and requires one of the interactions that follow to continue to the next step:

- Make a choice (Yes or No)
- Start an action (Start Color Change, Start Soak Timer and Start Purge Booster)
- Confirmation that the current step has been completed

Some steps require you to count injection shots and update the screen with the current shot or usage amount. This can be done using a cycle input signal (refer to [Section 13.2](#)).

The Ultra Purge mode buttons are at the bottom of the panel.

13.1.3 Ultra Purge Mode Buttons and Status

The buttons are used to start or cancel the Color Change process, and a status field that indicates the state of the process as it progresses (refer to [Table 13-2](#)).

Table 13-2 Ultra Purge Mode Button and Status Descriptions

Item	Description
Start	Touch this button to initiate the color change process. NOTE: The system must be in Running mode for this button to be enabled.
Status	This field displays what is happening with the sequence. The possible values are: <ul style="list-style-type: none"> • Not Started • In Progress • Complete
Cancel	Touch this button to cancel the process at any time. This action will reset the process to the beginning.

13.1.4 Color Change Settings Panel

The Color Change Settings panel has the user-configurable settings for increasing the temperature of the hot runner based on Ultra Purge recommendations. [Table 13-3](#) gives the descriptions for the items in the panel.

NOTE: For easy recall and to make sure the specific process is being applied to the correct mold, the settings in the panel are saved to the mold setup file that is loaded at the time the color change feature is being configured.

Table 13-3 Color Change Settings Descriptions

Item	Description
Tips Offset	This value is added to the normal temperature setpoint if it is in automatic regulation and classified as a 'Tips' heater type during color change mode.
Manifold Offset	This value is added to the normal temperature setpoint if it is in automatic regulation and classified as a 'Manifolds' heater type during color change mode.
Offset Maximum Limit	This value is applied when changing the Tips Offset or Manifolds Offset to prevent an unreasonable offset value being set for the Tips and Manifolds (relative value).
Temperature Maximum Limit	This value is applied when changing zone setpoints during a color change to prevent a temperature setting that could damage the hot runners (absolute value).

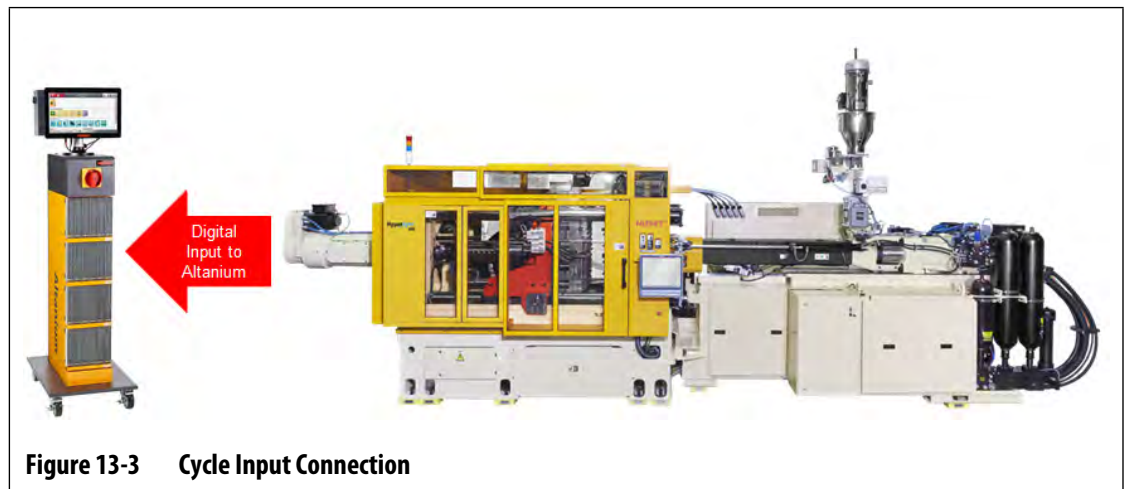
13.2 Cycle Input Connection

A digital connection between the Altanium controller and the injection molding machine maximizes the effectiveness of the color change feature by establishing an input to the controller to count the number of injection cycles. This connection is optional and is made using a discrete digital input (dry contact closure) to the Altanium controller from the injection molding machine.

The output from the machine must be connected to a cyclical signal that is triggered during each injection cycle. Some suggested outputs would be:

- Start of Injection
- Mold Open/Closed
- Ejector In/Out

NOTE: This cycle input connection is supported by the Altanium with any molding machine, regardless of manufacture.



13.3 Start the Ultra Purge Process

Do the steps that follow to start the Ultra Purge process (refer to [Figure 13-4](#)):

1. Configure the settings in the Ultra Purge Settings panel for the resin that you will use.
2. Touch the system **Start** button.



3. Wait for the system status to show Running mode.
4. Touch the Ultra Purge Sequence panel **Start** button.

The Ultra Purge process will guide you through the steps.

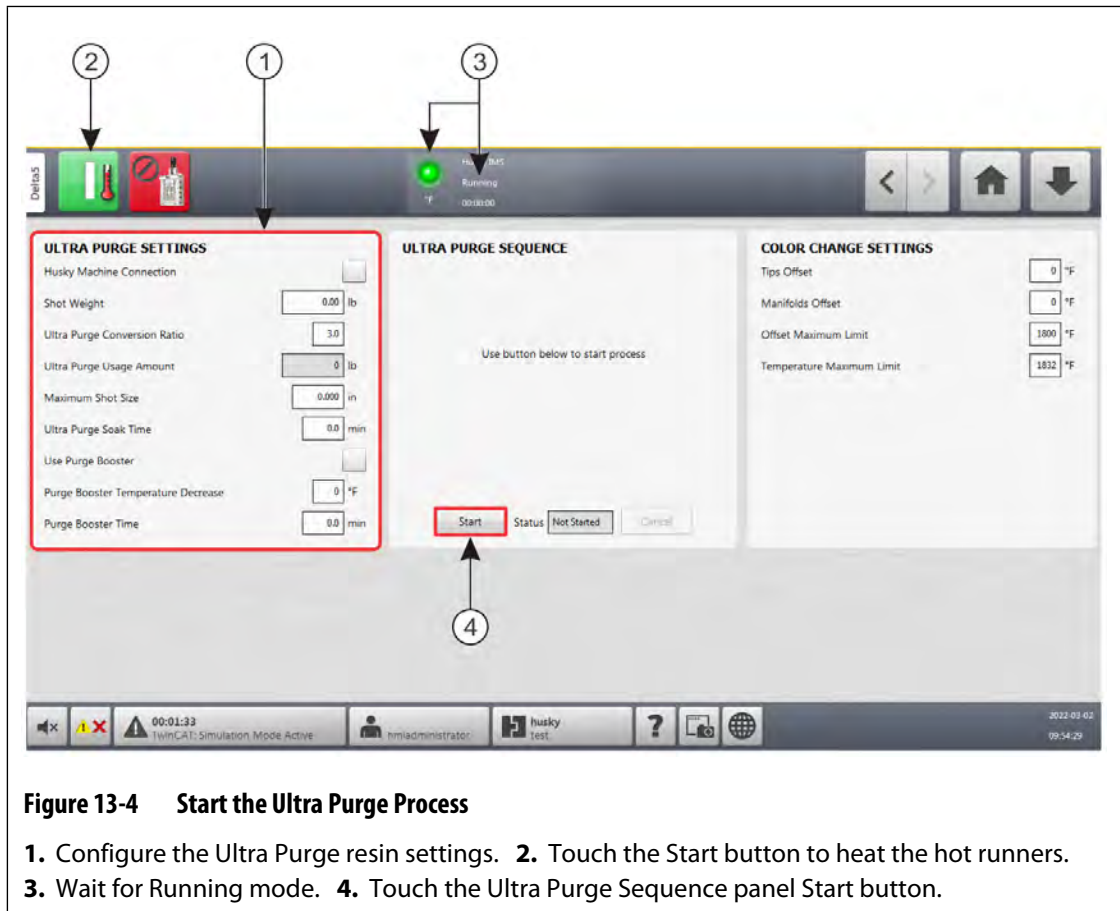


Figure 13-4 Start the Ultra Purge Process

1. Configure the Ultra Purge resin settings.
2. Touch the Start button to heat the hot runners.
3. Wait for Running mode.
4. Touch the Ultra Purge Sequence panel Start button.

13.4 Ultra Purge Process Sequences

This section gives the steps for different Ultra Purge process sequences.

13.4.1 Color Change and Non-Thermal Sensitive Resin

This process is followed for non-thermally sensitive resins and increases the tip and manifold temperatures before adding the Ultra-Purge compound to the IMM. The flowcharts in [Figure 13-5](#) define the supported sequences when performing a color change with non-thermal sensitive resin.

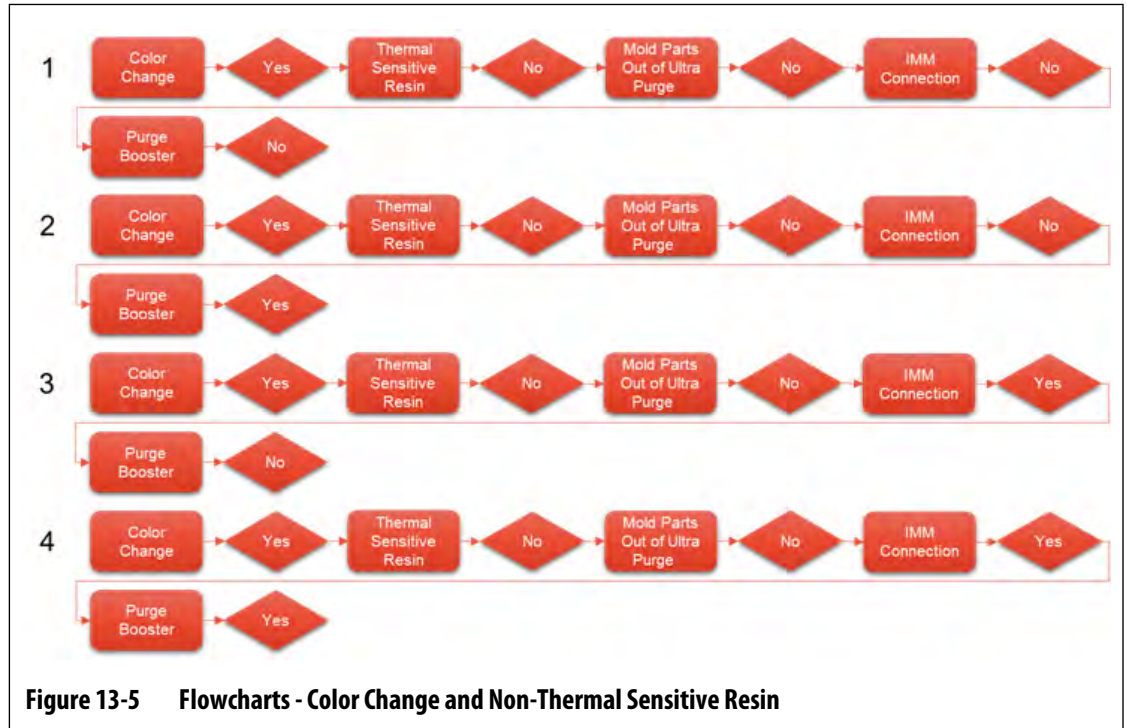
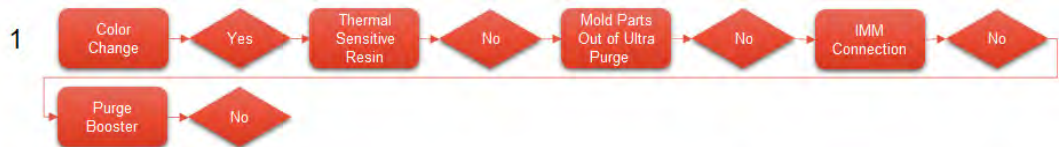


Figure 13-5 Flowcharts - Color Change and Non-Thermal Sensitive Resin

13.4.1.1 Color Change and Non-Thermal Sensitive Resin Example

The steps and figures that follow show the instructions only for sequence #1 in the process flowcharts (Figure 13-5), as displayed on the Altanium controller’s screens. All four sequences in Figure 13-5 must be done to complete the purge, but the steps that follow guide you through sequence #1 as an example.

NOTE: As you start each sequence in Figure 13-5, look through the sequence steps to see if the "Husky Machine Connection" or "Ultra Purge Booster" settings should be enabled or not enabled. Set them, as necessary, before you touch the Ultra Purge Sequence panel Start button.



1. Configure the settings in the Ultra Purge Settings panel for the resin that you will use.
2. Touch the system **Start** button, if necessary.



3. Wait for the system status to show Running mode, if necessary.
4. Touch the Ultra Purge Sequence panel **Start** button.

- When asked if you are performing a color change, touch the **Yes** button (refer to Figure 13-6).

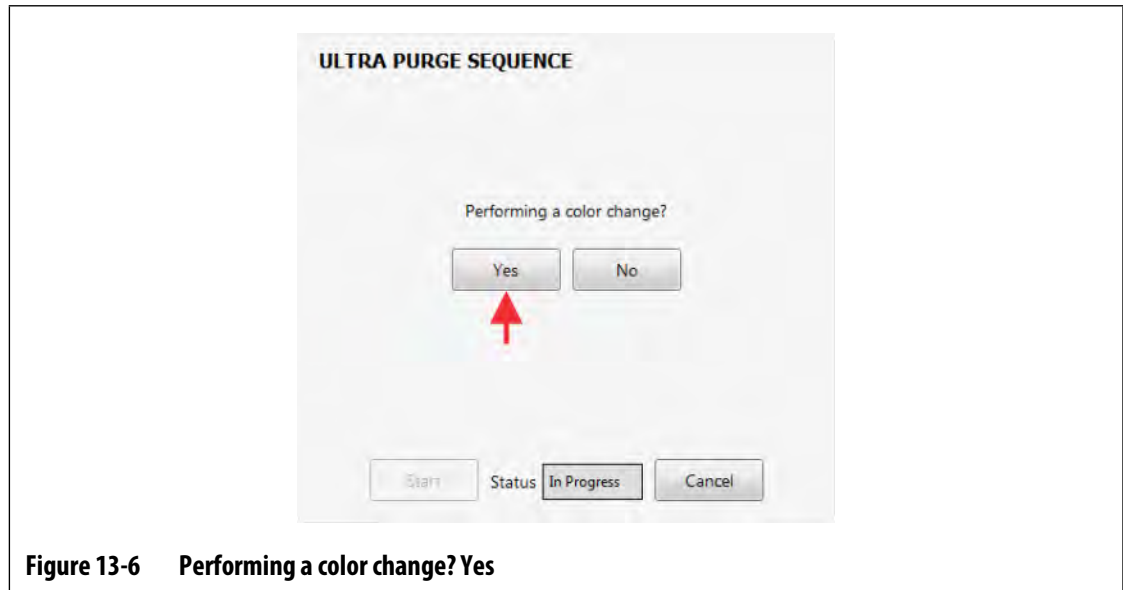


Figure 13-6 Performing a color change? Yes

- When asked if you have thermal sensitive resin, touch the **No** button (refer to Figure 13-7).



Figure 13-7 Thermal sensitive resin? No

7. Increase the tips and manifolds offset temperatures, as necessary (refer to [Figure 13-8](#)).
8. Touch the **Start Color Change** button and then the green check mark button to continue.

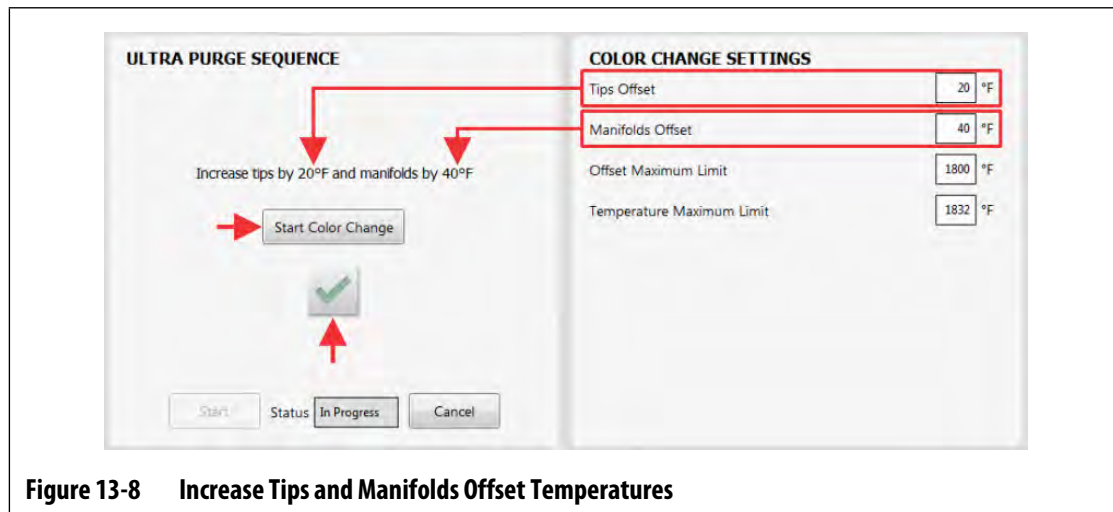


Figure 13-8 Increase Tips and Manifolds Offset Temperatures

9. Add the recommended amount of Ultra Purge compound to the IMM (refer to [Figure 13-9](#)).
10. When the compound had been added, touch the green check mark button to continue.

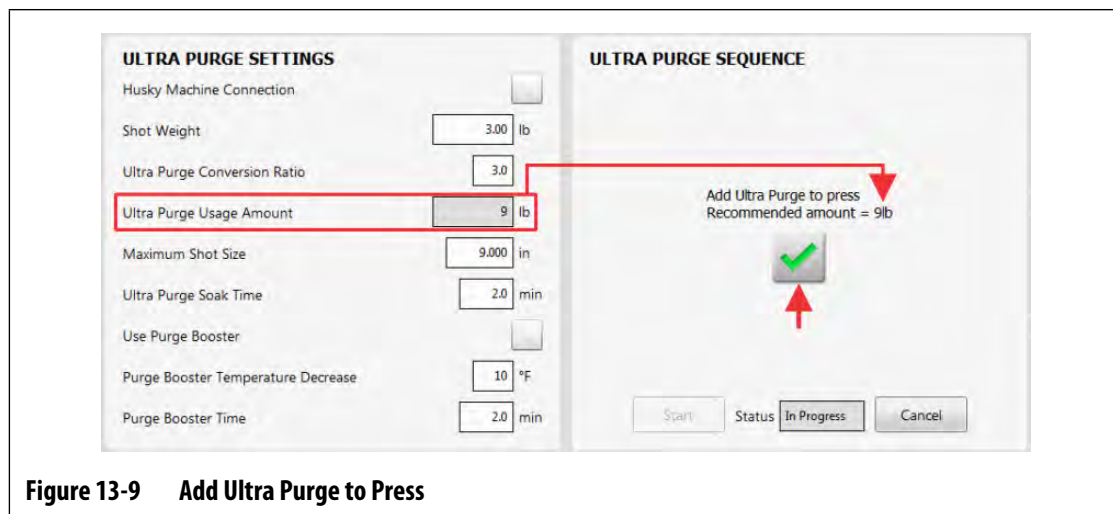


Figure 13-9 Add Ultra Purge to Press

11. Make sure that the Husky Machine Connection checkbox is not checked (refer to Figure 13-10).
12. When asked if "You are molding parts out of Ultra Purge?", touch the **No** button.

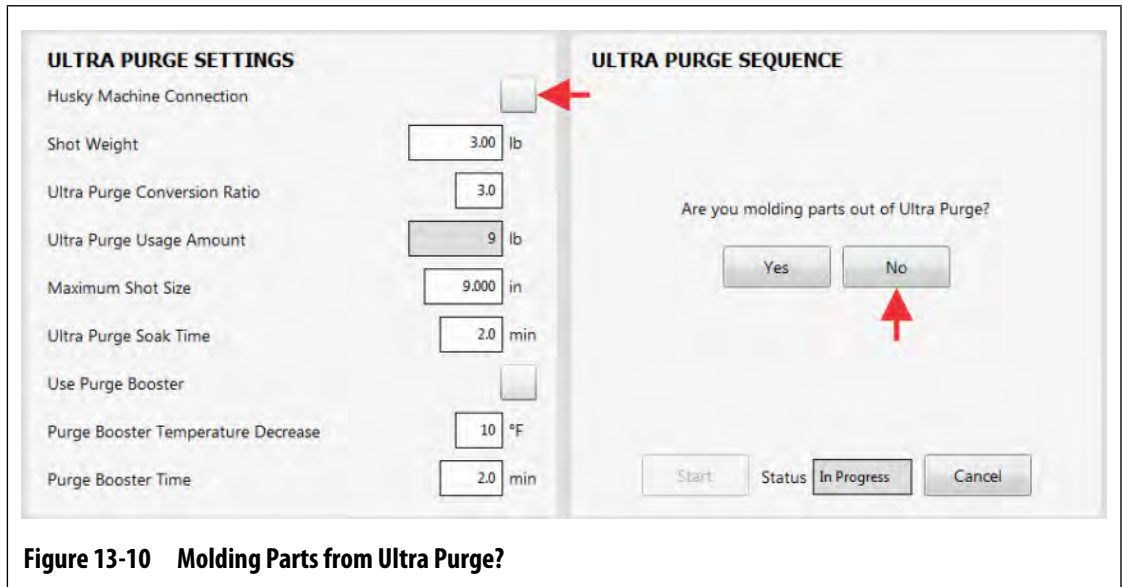


Figure 13-10 Molding Parts from Ultra Purge?

13. With the mold open, do ejection shots until you see the Ultra Purge compound come out of the hot runners.
14. Touch the green check mark to confirm that the compound comes out of the hot runners (Figure 13-11).

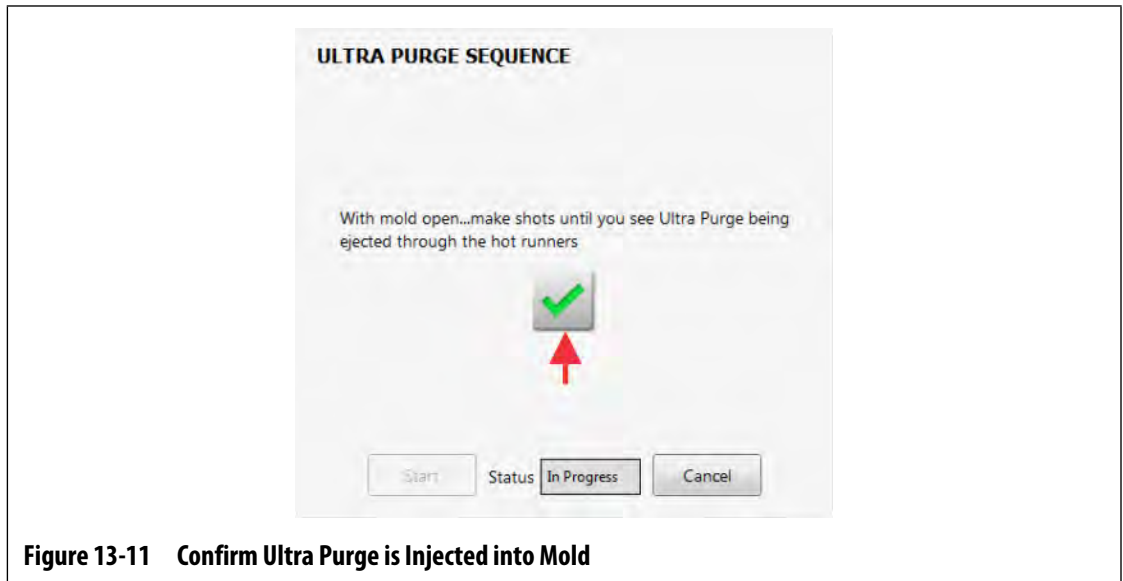


Figure 13-11 Confirm Ultra Purge is Injected into Mold

15. Reduce the shot size to 15% of the maximum shot size allowed (refer to [Figure 13-12](#)).
16. With the mold open, do two short injection shots through the mold.
17. Touch the check mark button to continue ([Figure 13-12](#)).

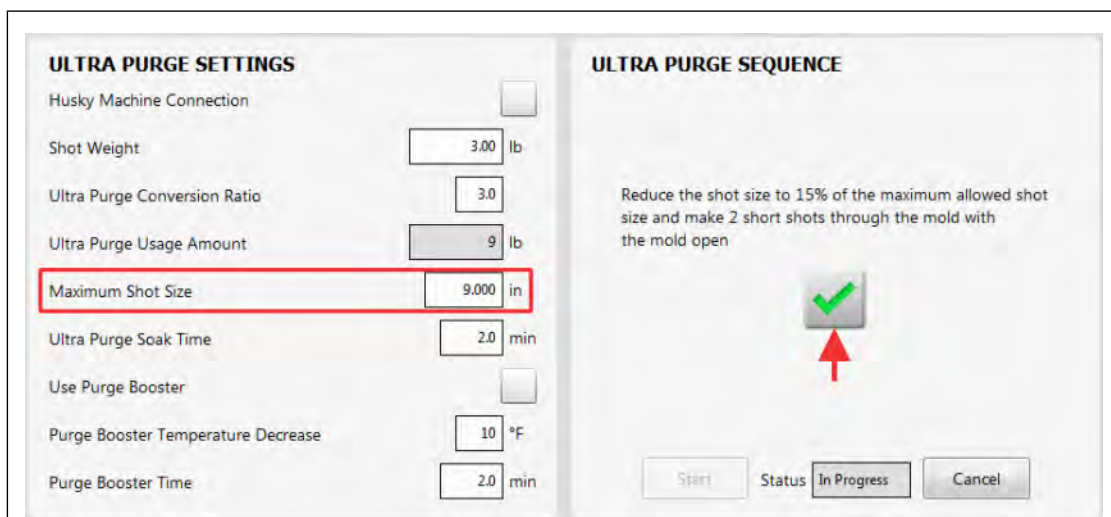


Figure 13-12 Reduce Shot Size to 15% of the Maximum Allowed

18. After the hot runners are filled with Ultra Purge, touch the **Start Soak Timer** button let the soak timer complete ([Figure 13-13](#)).

NOTE: The elapse time is shown on the screen above the Start Soak Timer button.

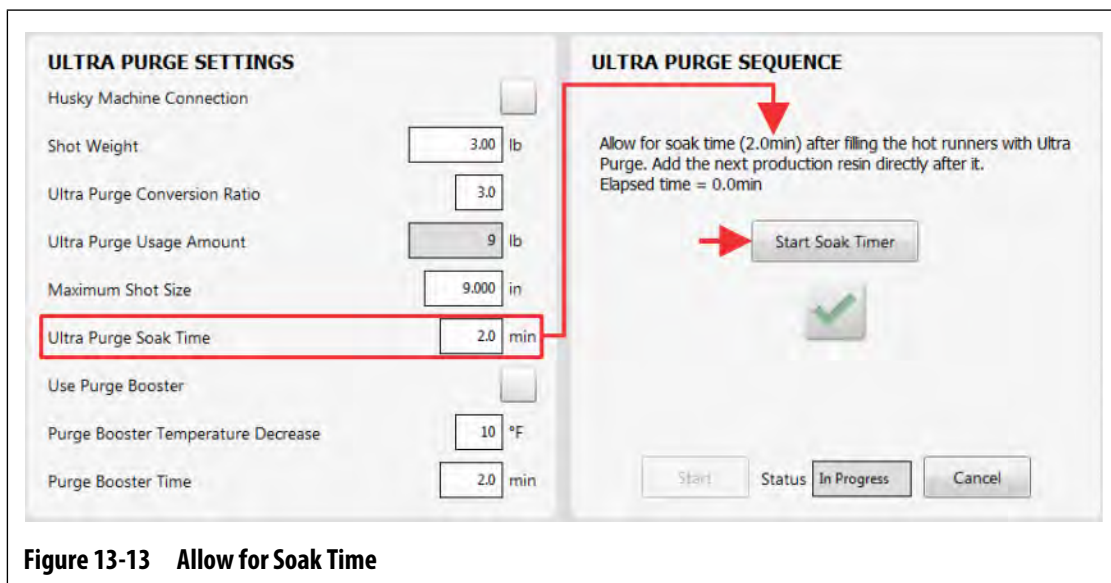


Figure 13-13 Allow for Soak Time

- 19. When the soak timer has completed, touch the check mark button to continue (Figure 13-14).

NOTE: The check mark button becomes enabled when the soak time completes.

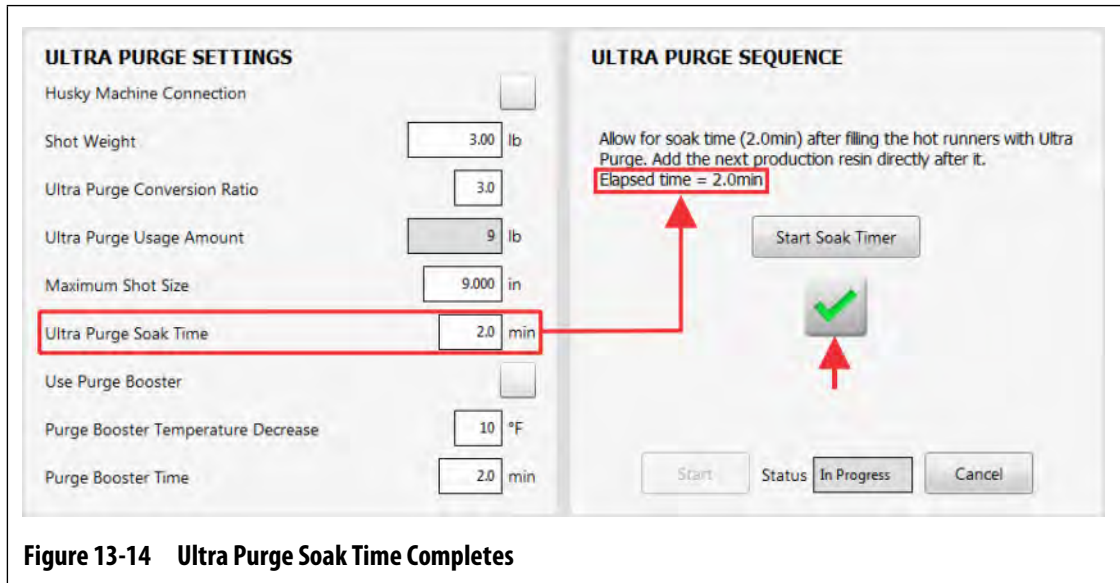


Figure 13-14 Ultra Purge Soak Time Completes

- 20. Load the new color or production resin into the IMM (Figure 13-15).

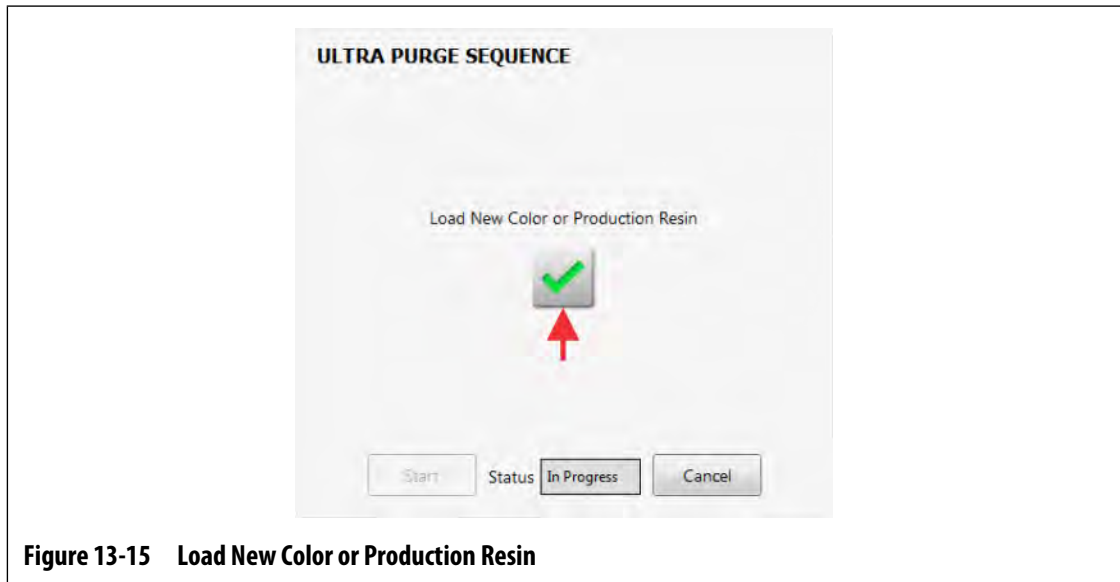


Figure 13-15 Load New Color or Production Resin

21. Continue to do short injection shots with the Ultra Purge (Figure 13-16).

NOTE: This helps flush the Ultra Purge and bring the new color resin to the hot runners.

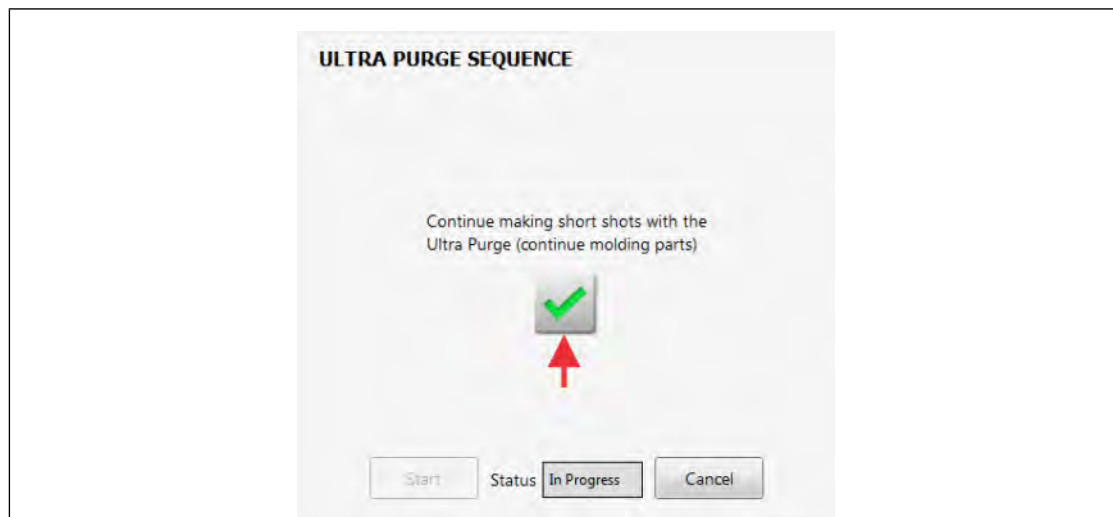


Figure 13-16 Continue to Do Short Injection Shots with Ultra Purge

22. Make sure that the Husky Machine Connection checkbox does not have a check mark (not enabled) and then do four to five injection shots with the new production resin (Figure 13-17).

NOTE: This makes sure that the new production resin flows through the hot runners.

23. Touch the green check mark button when you have completed the injection shots.

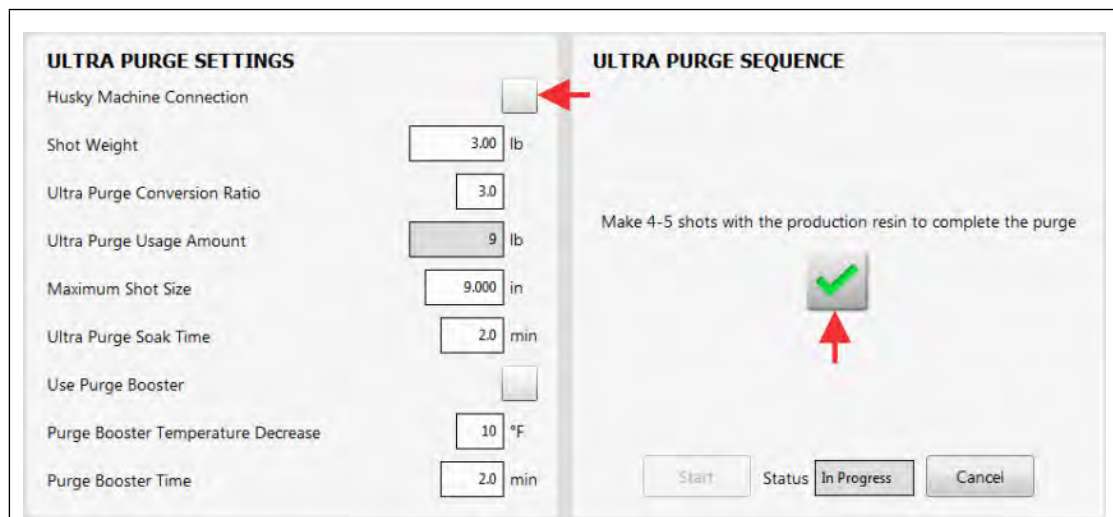


Figure 13-17 Do Four to Five Injection Shots with the New Production Resin

24. Touch the green check mark button to confirm that the purging has completed (Figure 13-18).

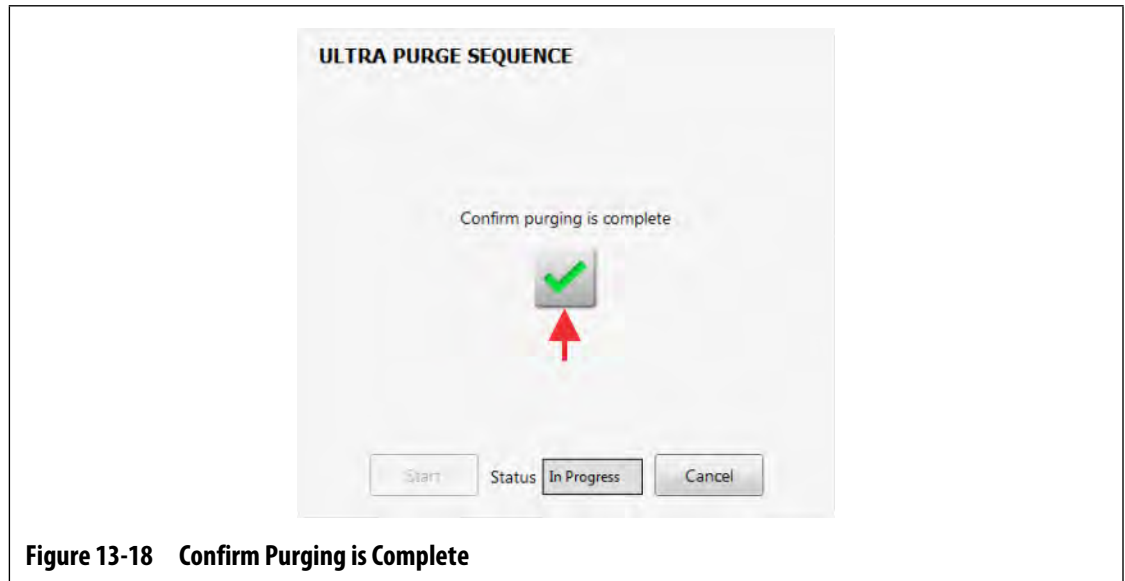


Figure 13-18 Confirm Purging is Complete

25. Make sure that the Use Purge Booster checkbox does not have a check mark (not enabled) (refer to Figure 13-19).
26. Adjust the hot runners' temperatures to their operational parameters.
27. When the temperatures are at their parameter settings, touch the green check mark button.

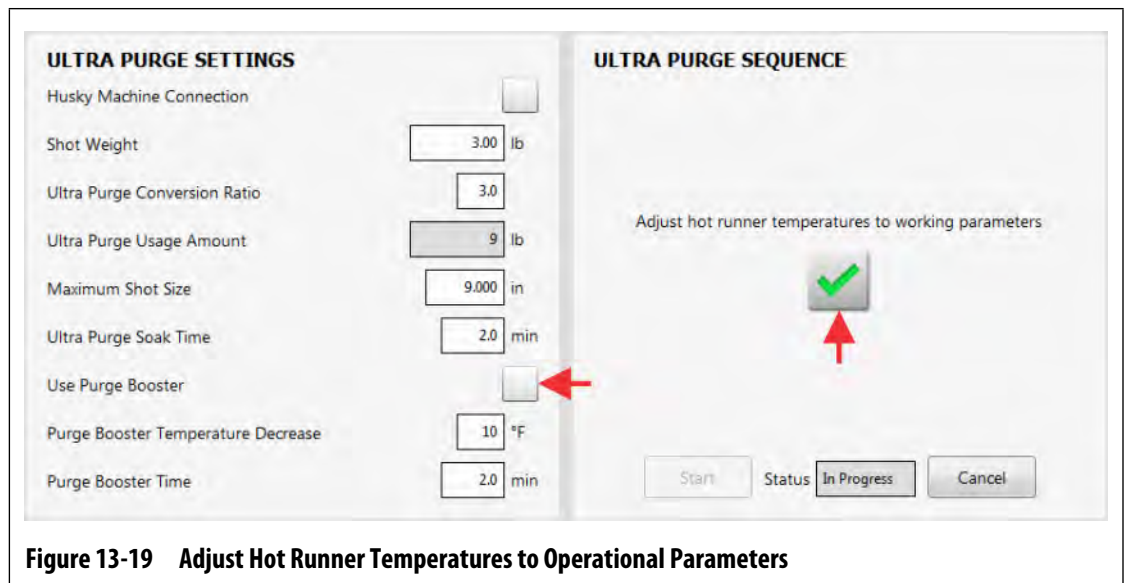


Figure 13-19 Adjust Hot Runner Temperatures to Operational Parameters

28. Touch the green check mark button to complete the Ultra Purge process (Figure 13-20).

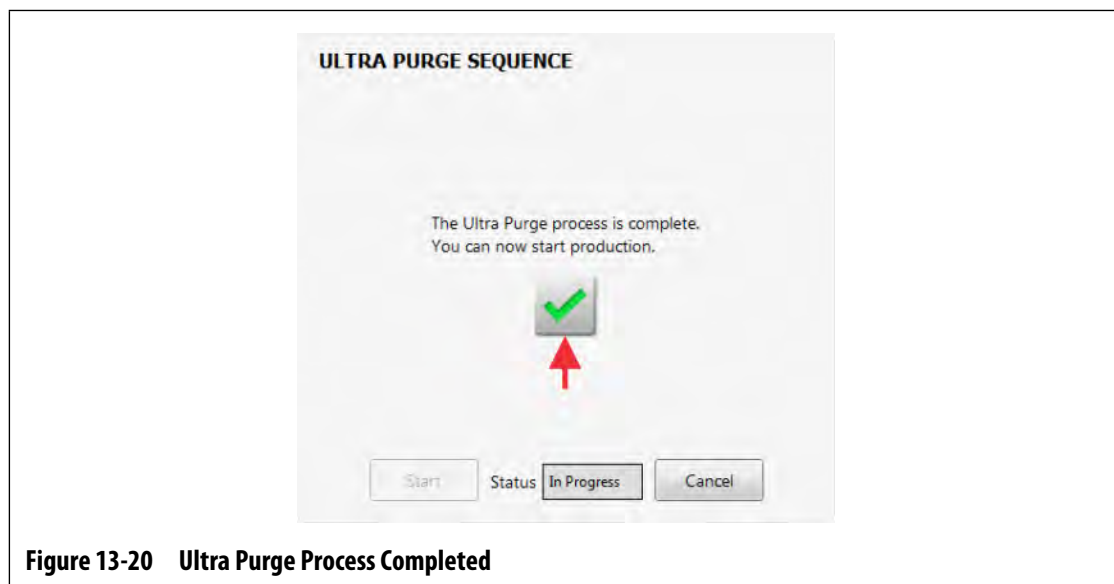


Figure 13-20 Ultra Purge Process Completed

13.4.2 Color Change and Thermal Sensitive Resin

This process is followed for thermally sensitive resins and increases the tip and manifold temperatures before adding the Ultra-Purge compound to the IMM. The flowcharts in Figure 13-21 define the supported sequences when performing a color change with non-thermal sensitive resin.

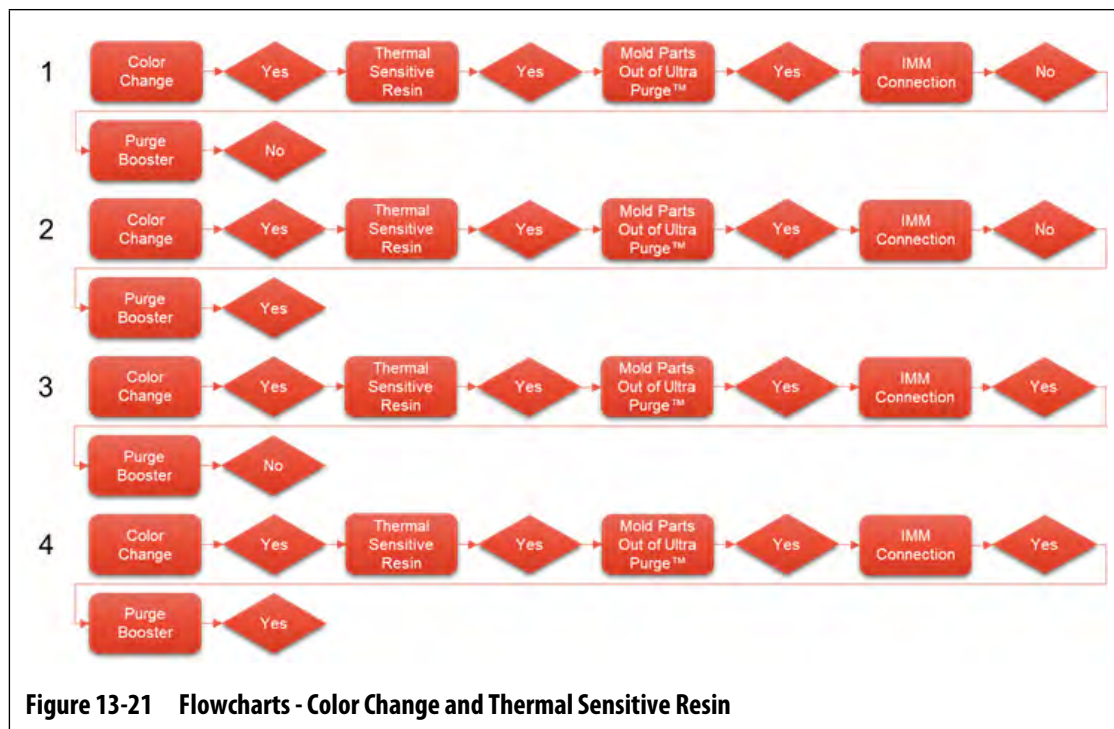
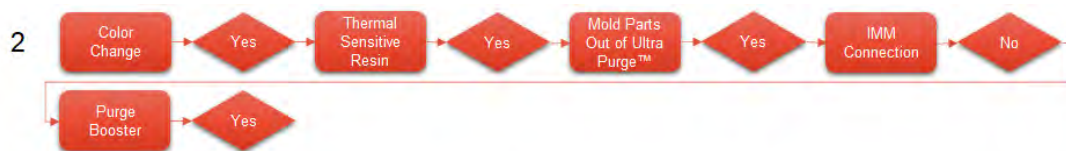


Figure 13-21 Flowcharts - Color Change and Thermal Sensitive Resin

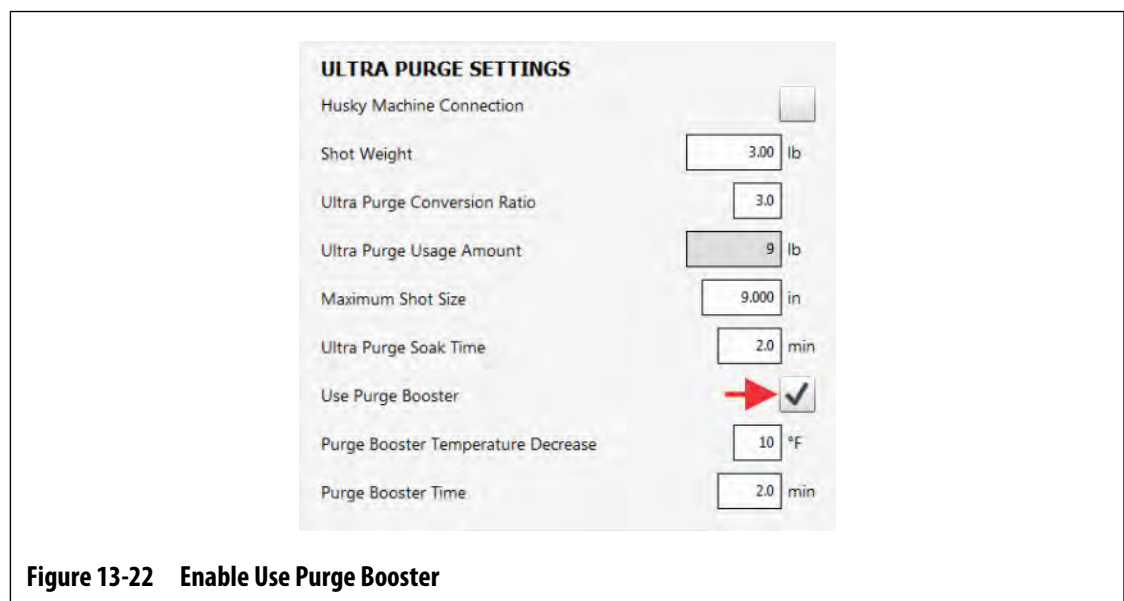
13.4.2.1 Color Change and Thermal Sensitive Resin Example

The steps and figures that follow show the instructions only for sequence #2 in the process flowcharts (Figure 13-21), as displayed on the Altanium controller's screens. All four sequences in Figure 13-21 must be done to complete the purge, but the steps that follow guide you through sequence #2 as an example.

NOTE: As you start each sequence in Figure 13-21, look through the sequence steps to see if the "Husky Machine Connection" or "Ultra Purge Booster" settings should be enabled or not enabled. Set them, as necessary, before you touch the Ultra Purge Sequence panel Start button.



1. Configure the settings in the Ultra Purge Settings panel for the resin that you will use.
2. Touch the Use Purge Booster checkbox, so a check mark shows (refer to Figure 13-22).



3. Touch the system **Start** button, if necessary.



4. Wait for the system status to show Running mode, if necessary.
5. Touch the Ultra Purge Sequence panel **Start** button.

- When asked if you are performing a color change, touch the **Yes** button (refer to Figure 13-23).

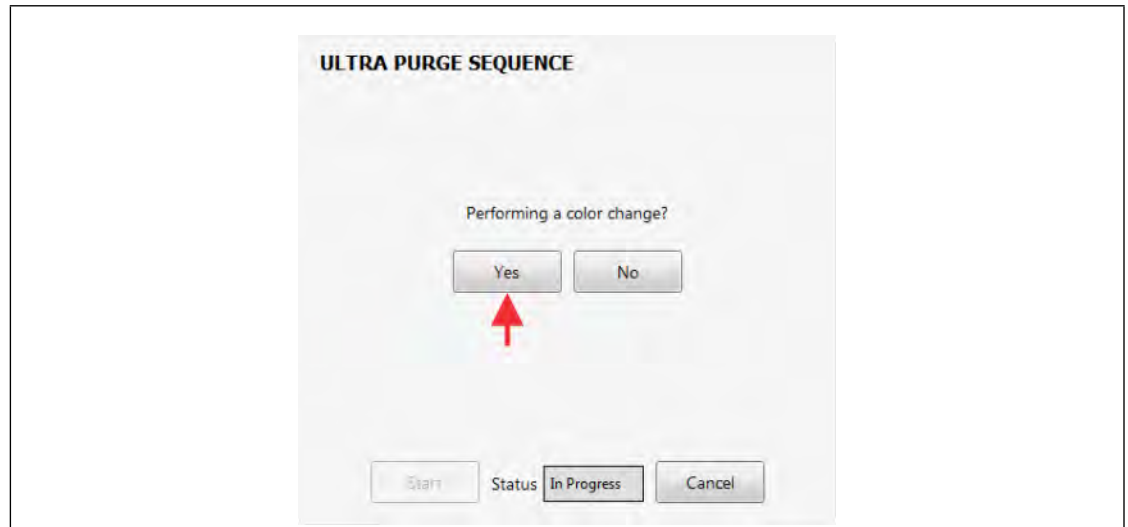


Figure 13-23 Performing a color change? Yes

- When asked if you have thermal sensitive resin, touch the **Yes** button (refer to Figure 13-24).

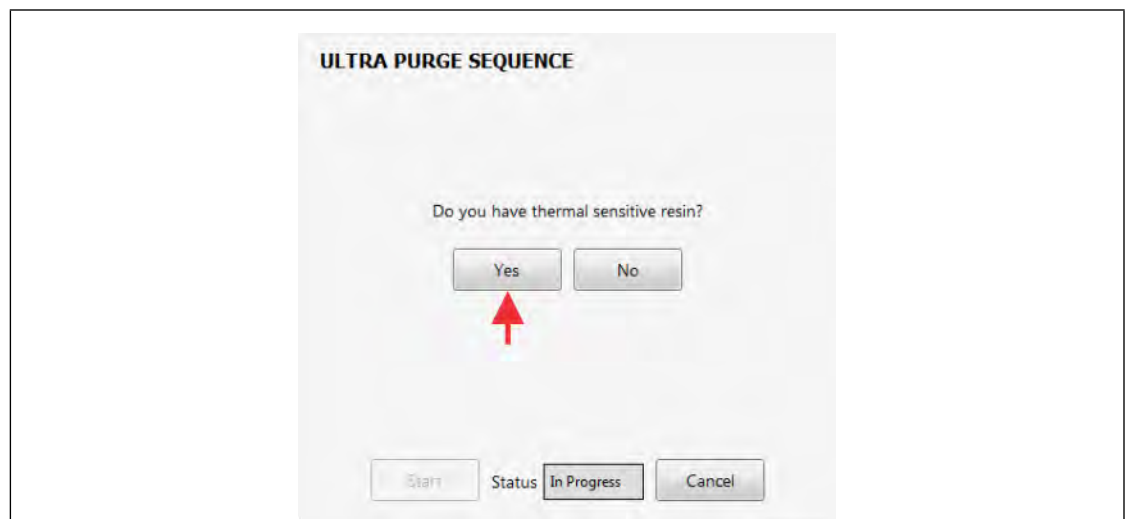


Figure 13-24 Thermal sensitive resin? No

8. Add the recommended amount of Ultra Purge compound to the IMM (refer to Figure 13-25).
9. When the compound had been added, touch the green check mark button to continue.

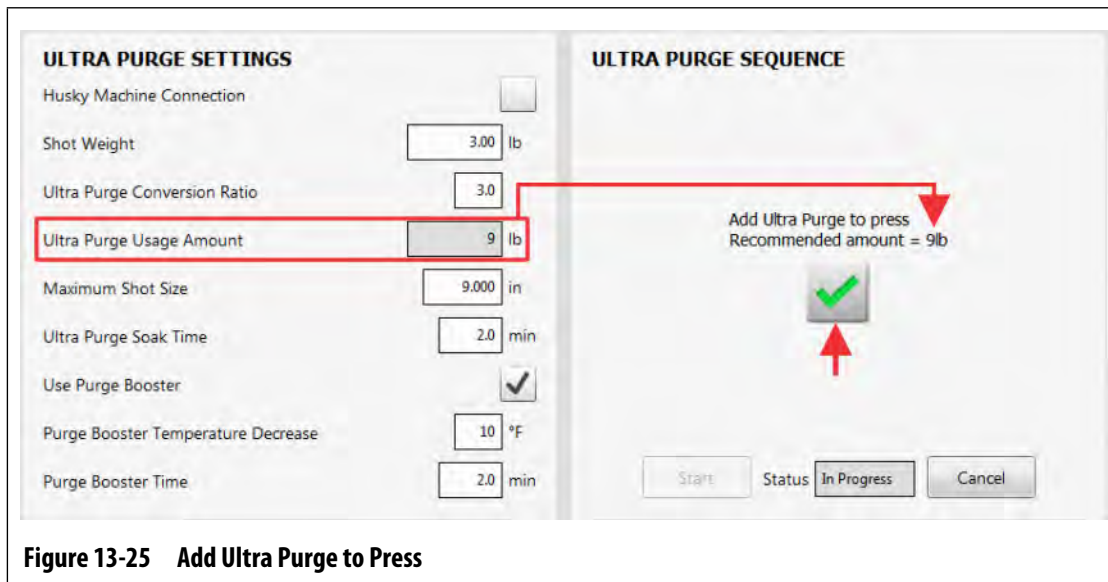


Figure 13-25 Add Ultra Purge to Press

10. Make sure that the Husky Machine Connection checkbox is not checked (refer to Figure 13-26).
11. When asked if "You are molding parts out of Ultra Purge?", touch the **Yes** button.

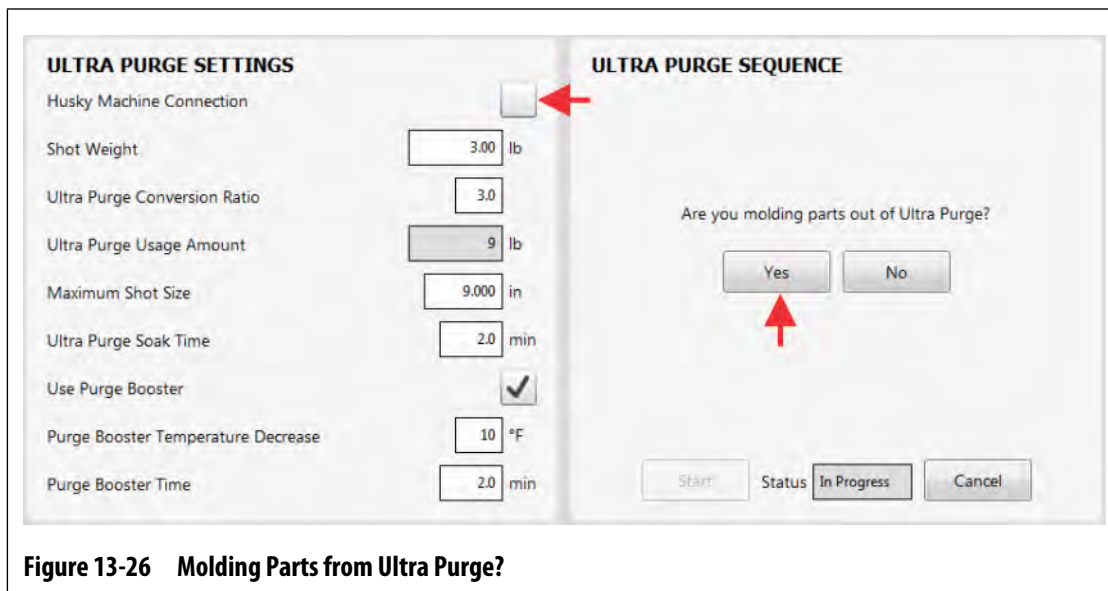


Figure 13-26 Molding Parts from Ultra Purge?

12. Mold parts until Ultra Purge is 100% in the molded parts.

13. Touch the green check mark to continue (Figure 13-27).

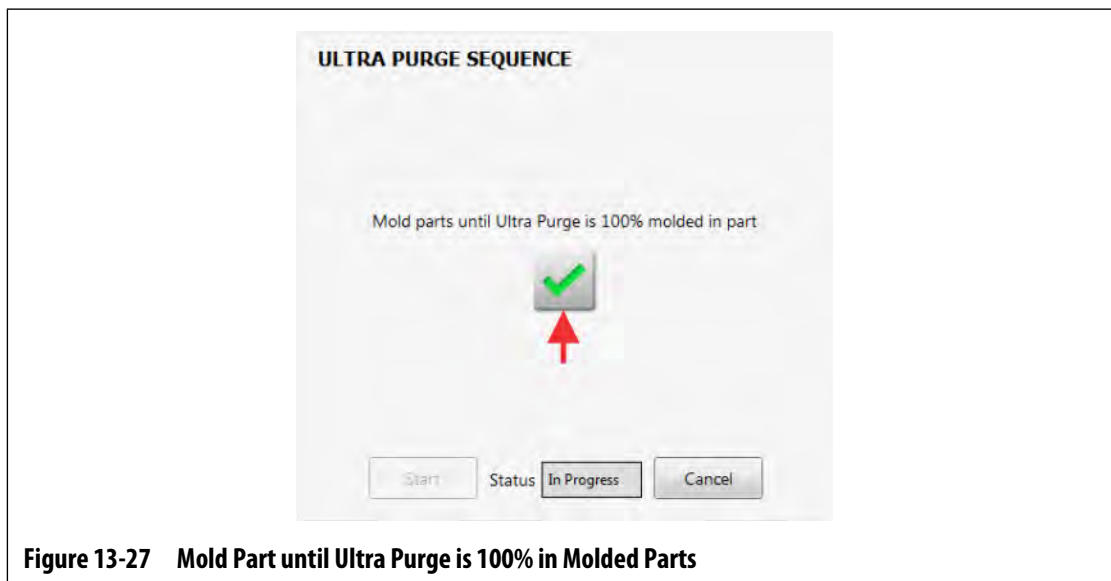


Figure 13-27 Mold Part until Ultra Purge is 100% in Molded Parts

14. Touch the **Start Soak Timer** button and let the soak timer complete (Figure 13-28).

NOTE: The elapse time is shown on the screen above the Start Soak Timer button.

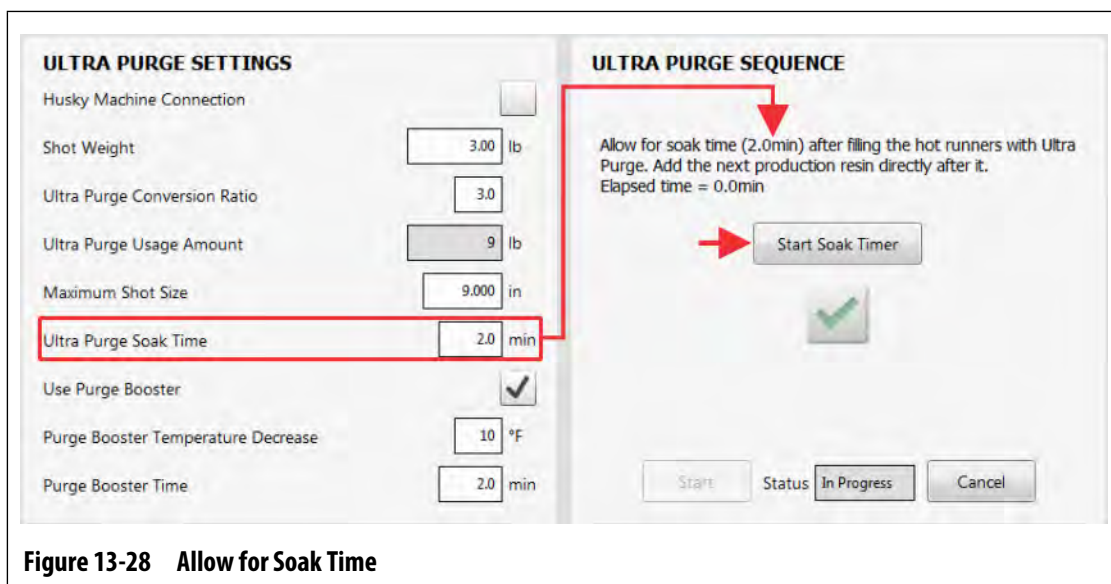


Figure 13-28 Allow for Soak Time

- When the soak time has completed, touch the check mark button to continue (Figure 13-29).

NOTE: The check mark button becomes enabled when the soak time completes.

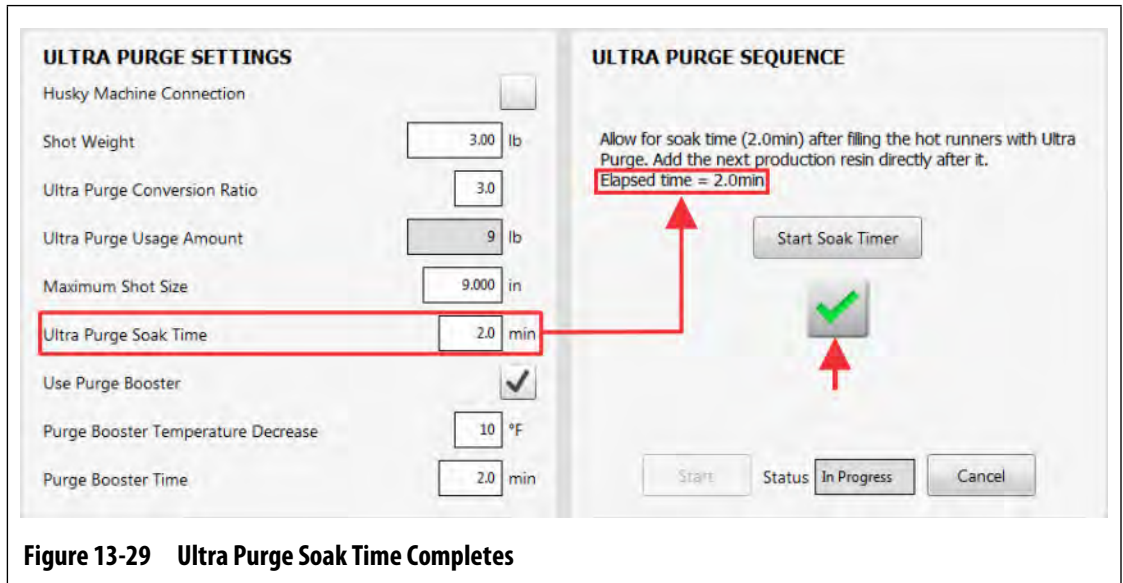


Figure 13-29 Ultra Purge Soak Time Completes

- Load the new color or production resin into the IMM (Figure 13-30).

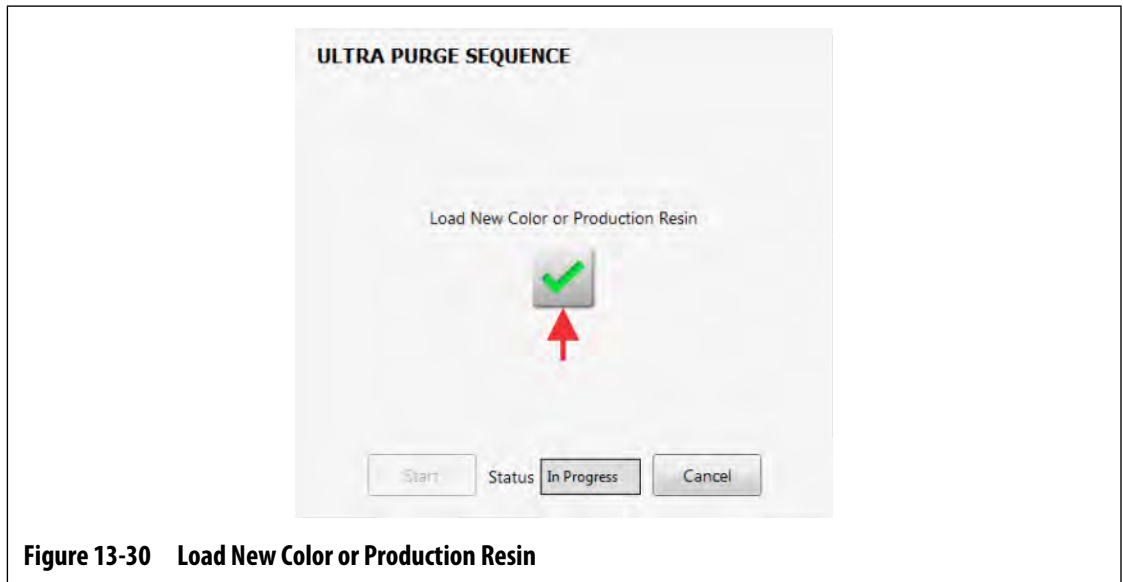


Figure 13-30 Load New Color or Production Resin

17. Continue to do short injection shots with the Ultra Purge (Figure 13-31).

NOTE: This helps flush the Ultra Purge and bring the new color resin to the hot runners.

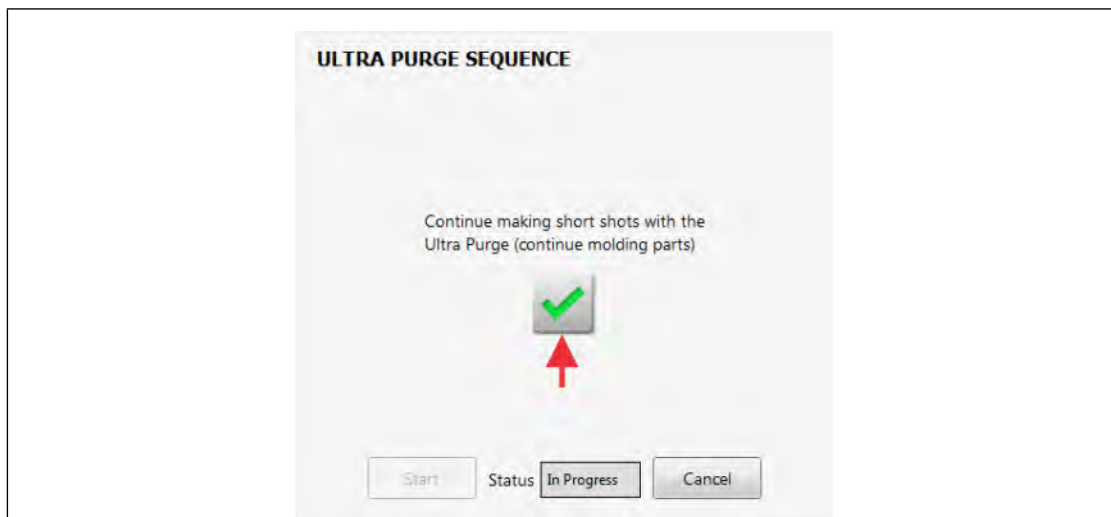


Figure 13-31 Continue to Do Short Injection Shots with Ultra Purge

18. Do four to five injection shots with the new production resin to complete the purge (Figure 13-32).

NOTE: This makes sure that the new production resin flows through the hot runners.

19. Touch the green check mark button when you have completed the injection shots.



Figure 13-32 Do Four to Five Injection Shots with the New Production Resin

20. Touch the green check mark button to confirm that the purging has completed (Figure 13-33).

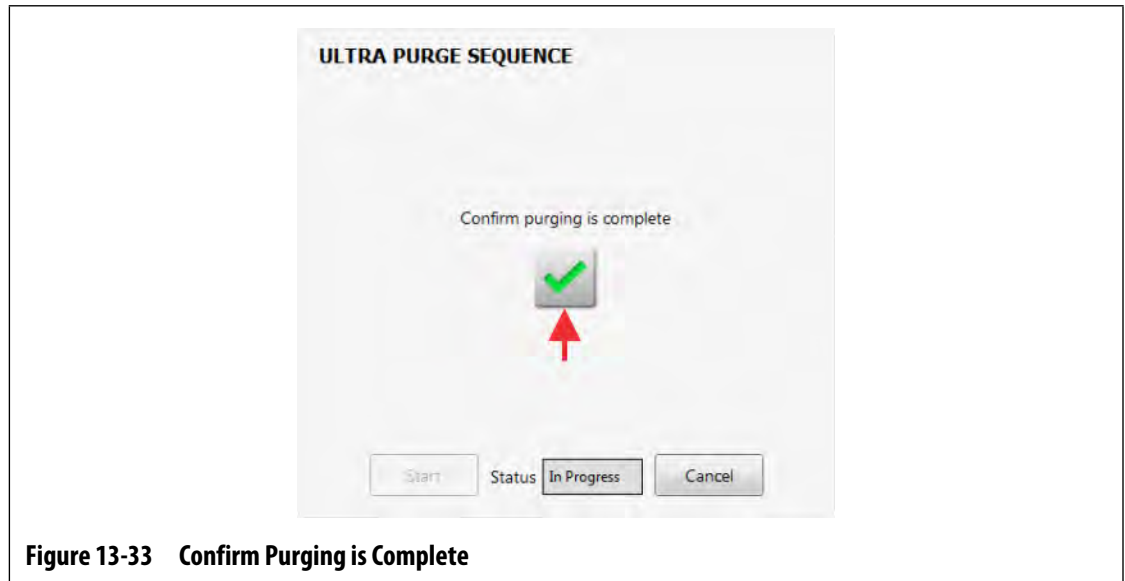


Figure 13-33 Confirm Purging is Complete

21. Adjust the hot runner temperature to x °F (x °C) below the normal setpoint (refer to Figure 13-34).
22. Touch the **Start Purge Booster** button.

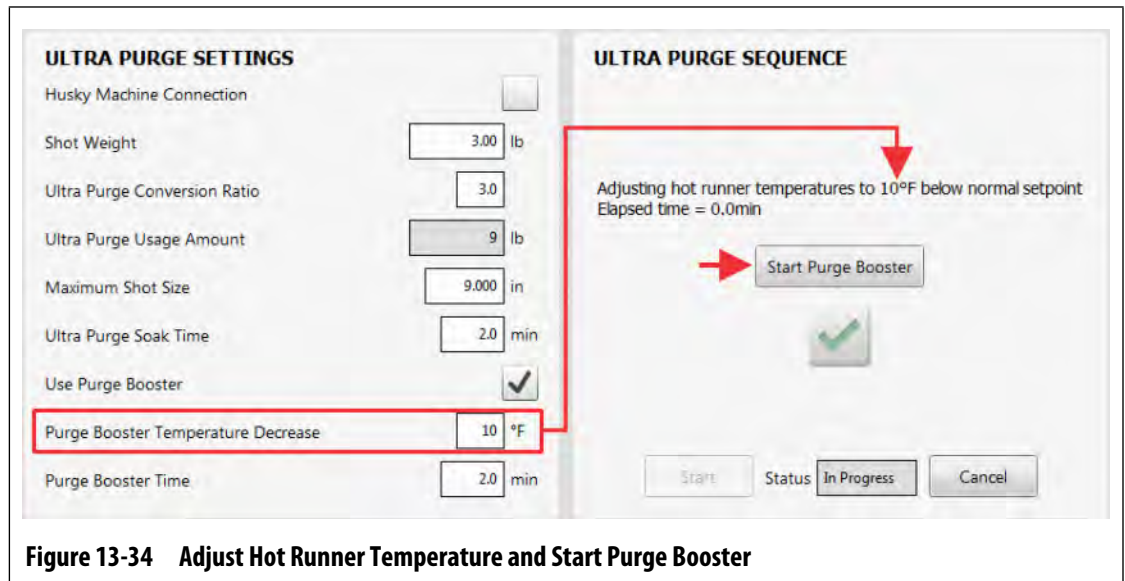


Figure 13-34 Adjust Hot Runner Temperature and Start Purge Booster

23. When the Purge Booster Time completes, touch the green check mark button to continue (refer to [Figure 13-35](#).)

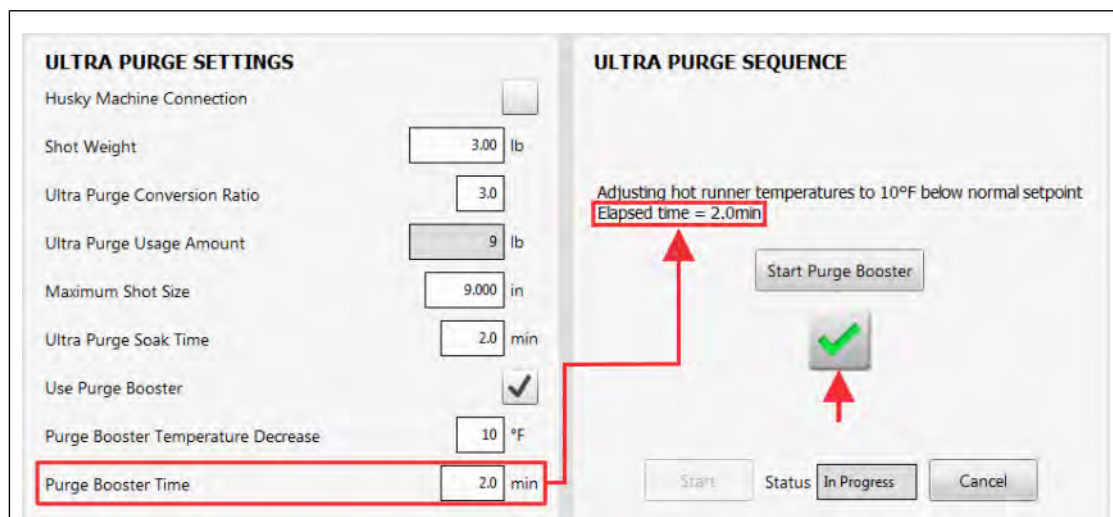


Figure 13-35 Purge Booster Time Completes

24. Adjust the hot runners' temperatures to their operational parameters.
25. When the temperatures are at their parameter settings, touch the green check mark button to continue (refer to [Figure 13-36](#).)

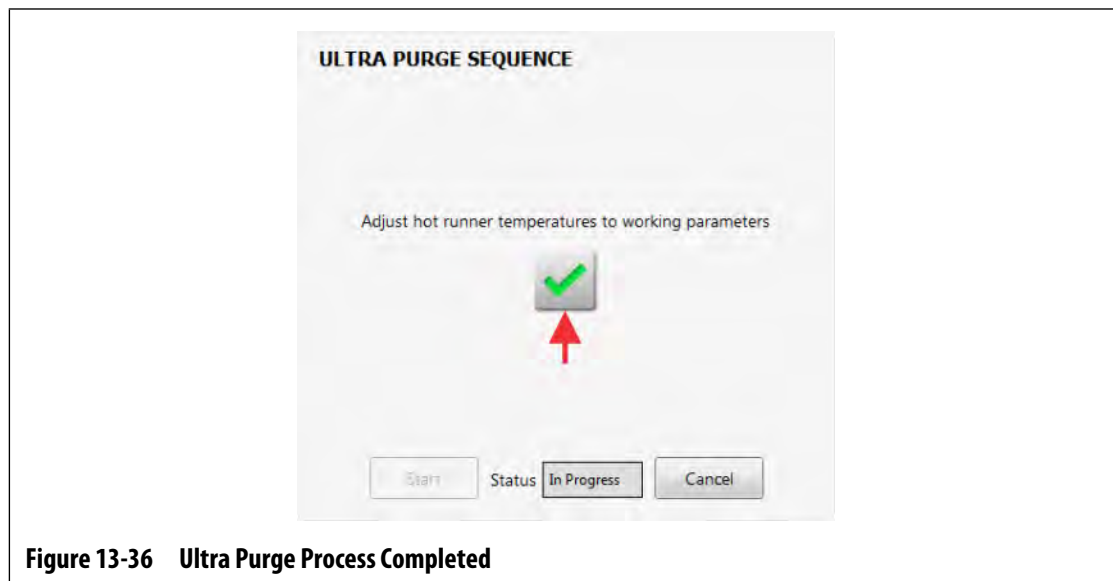


Figure 13-36 Ultra Purge Process Completed

26. Touch the green check mark button to complete the Ultra Purge process (Figure 13-37). You can start production with the new resin.



Figure 13-37 Ultra Purge Process Completed

13.4.3 No Color Change

This process is followed when cleaning the hot runner system is required to help flush out degraded/carbonized resin deposits in the flow channels. The flowcharts (Figure 13-38) below define the supported sequences when cleaning the hot runner with no color change.

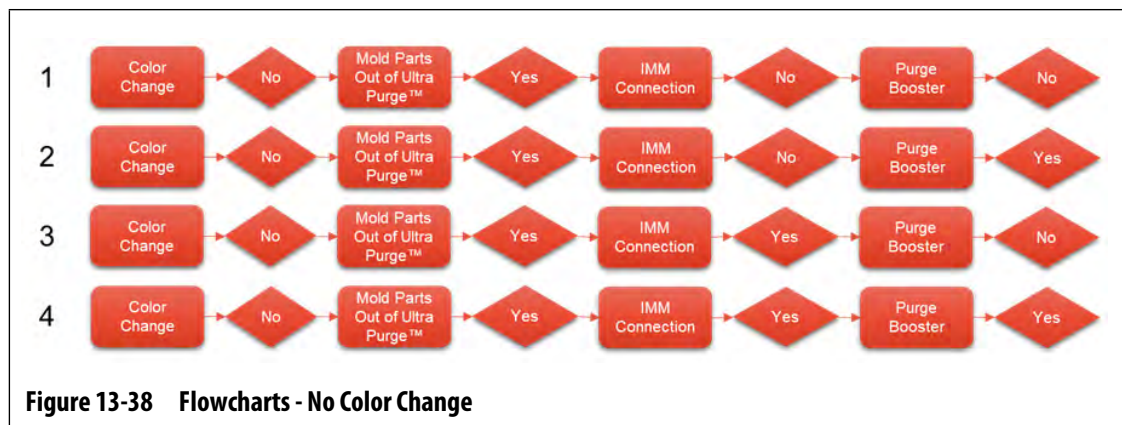


Figure 13-38 Flowcharts - No Color Change

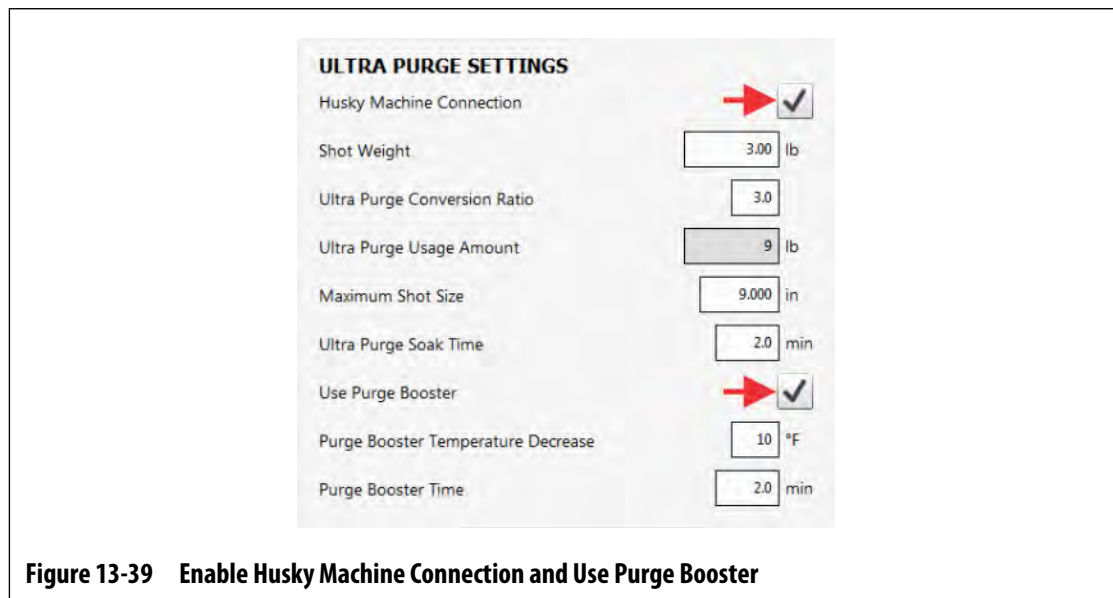
13.4.3.1 No Color Change Example

The steps and figures that follow show the instructions only for sequence #4 in the process flowcharts (Figure 13-38), as displayed on the Altanium controller’s screens. All four sequences in Figure 13-38 must be done to complete the purge, but the steps that follow guide you through sequence #4 as an example.

NOTE: As you start each sequence in Figure 13-38, look through the sequence steps to see if the "Husky Machine Connection" or "Ultra Purge Booster" settings should be enabled or not enabled. Set them, as necessary, before you touch the Ultra Purge Sequence panel Start button.



1. Configure the settings in the Ultra Purge Settings panel for the resin that you will use.
2. Touch the **Husky Machine Connection** and **Use Purge Booster** checkboxes, so the check marks show (refer to [Figure 13-39](#)).



3. Touch the system **Start** button, if necessary.



4. Wait for the system status to show Running mode, if necessary.
5. Touch the Ultra Purge Sequence panel **Start** button.

- 6. When asked if you are performing a color change, touch the **No** button (refer to Figure 13-40).

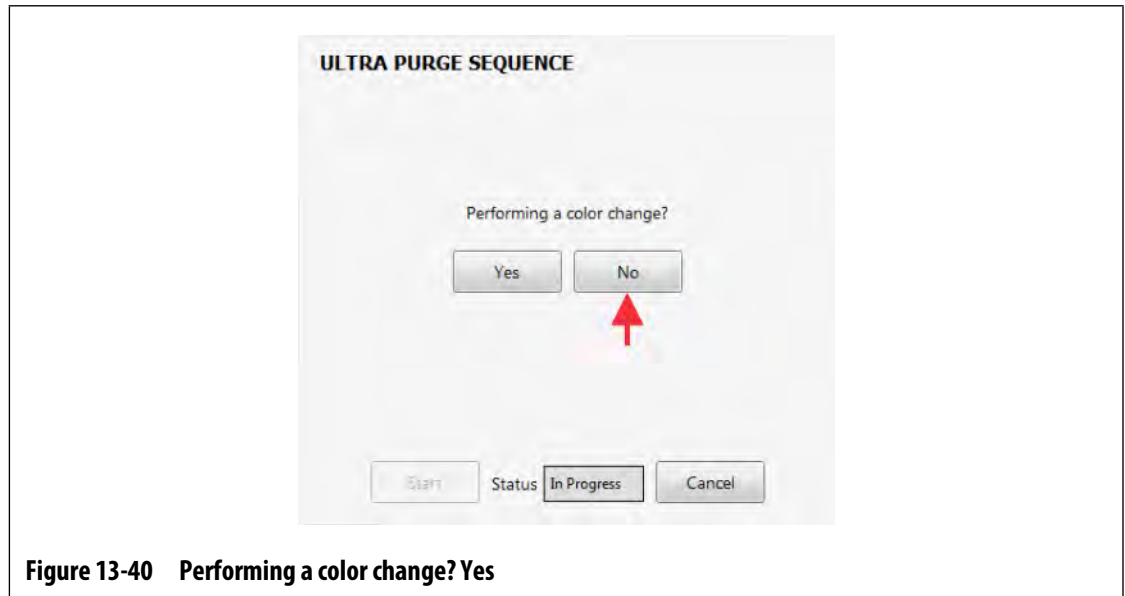


Figure 13-40 Performing a color change? Yes

- 7. Add the recommended amount of Ultra Purge compound to the IMM (refer to Figure 13-41).
- 8. When the compound had been added, touch the green check mark button to continue.

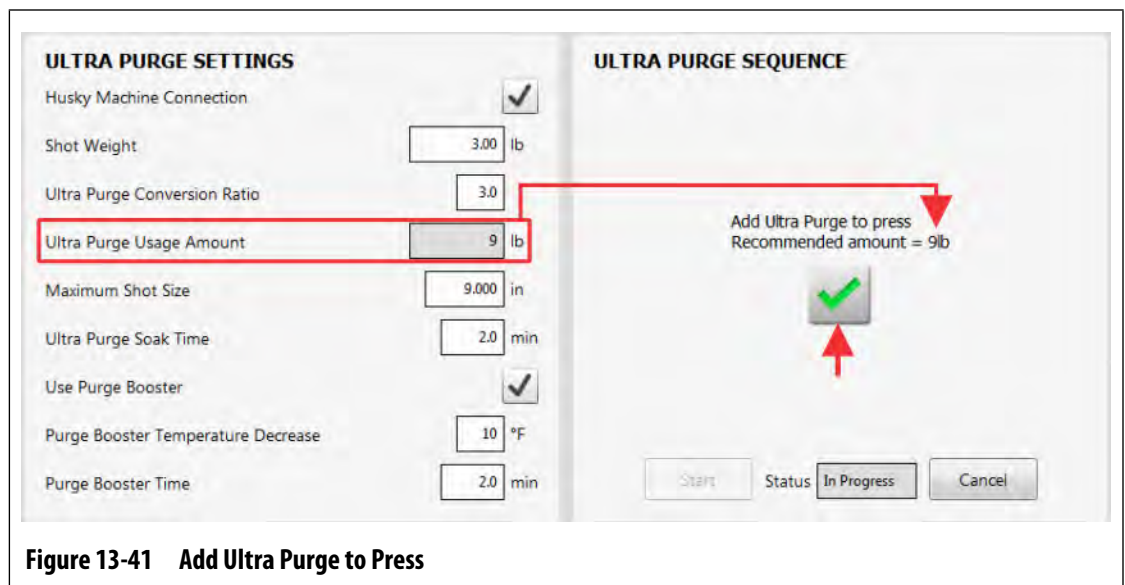


Figure 13-41 Add Ultra Purge to Press

- When asked if "You are molding parts out of Ultra Purge?", touch the **Yes** button (refer to Figure 13-42).



Figure 13-42 Molding Parts from Ultra Purge?

With the Husky Machine Connection enabled, the controller will count the shots and calculate when the Ultra Purge Usage Amount is achieved.

- Touch the green check mark button when the controller gets to the Ultra Purge Usage Amount (refer to Figure 13-43).

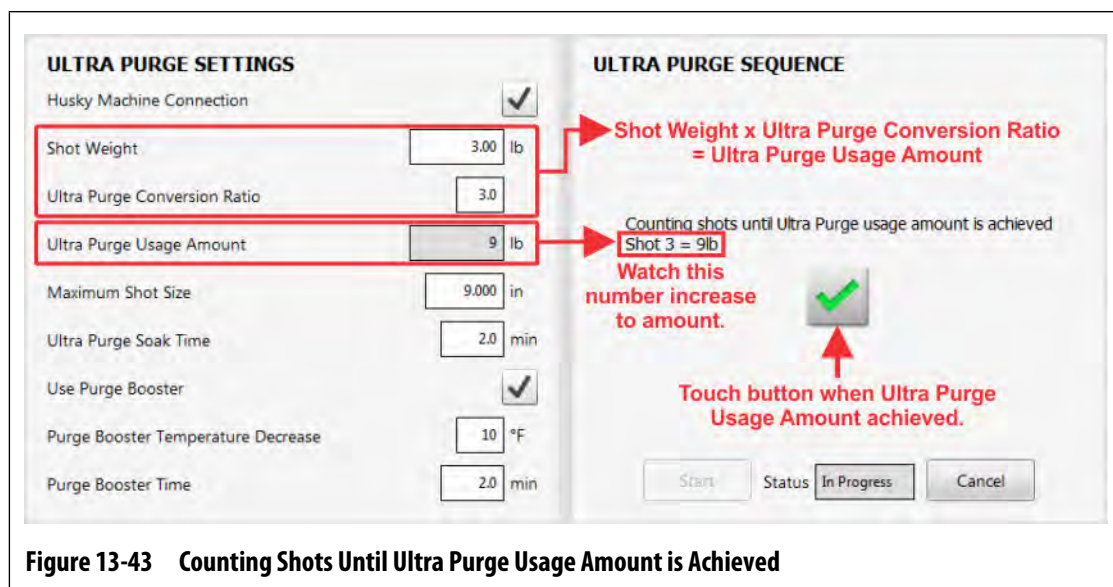


Figure 13-43 Counting Shots Until Ultra Purge Usage Amount is Achieved

11. Touch the **Start Soak Timer** button and let the soak timer complete (Figure 13-44).

NOTE: The elapse time is shown on the screen above the Start Soak Timer button.

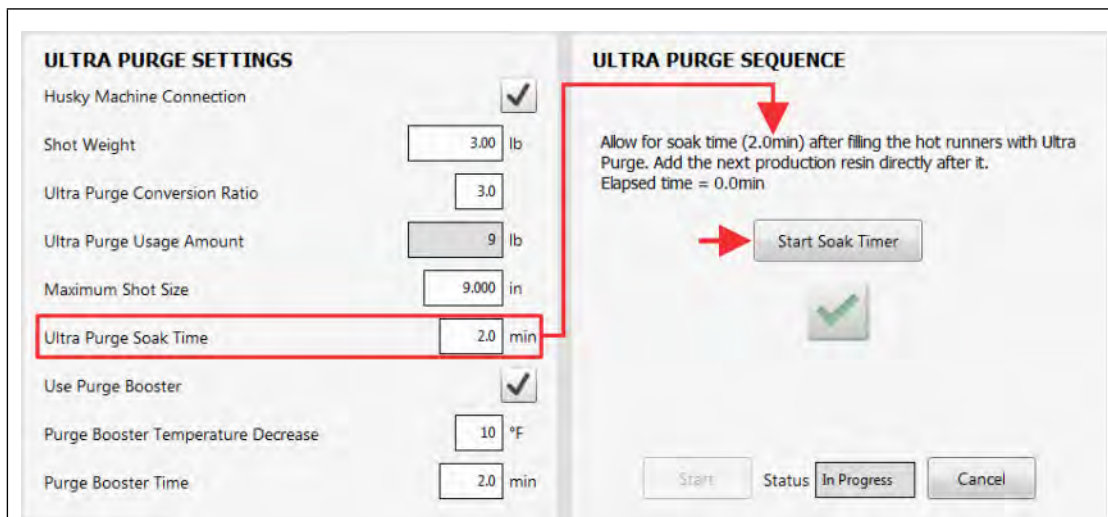


Figure 13-44 Allow for Soak Time

12. When the soak time has completed, touch the check mark button to continue (Figure 13-45).

NOTE: The check mark button becomes enabled when the soak time completes.

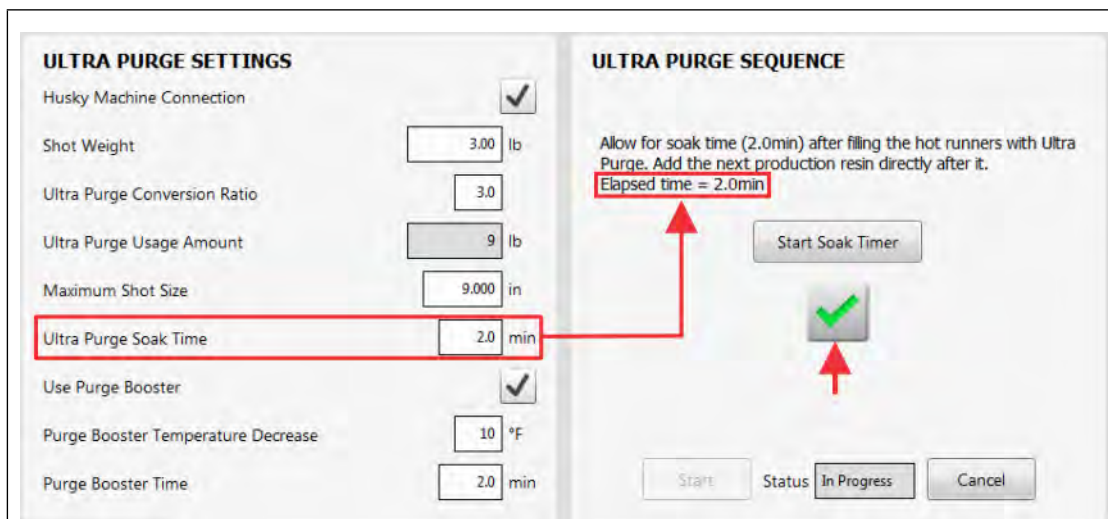
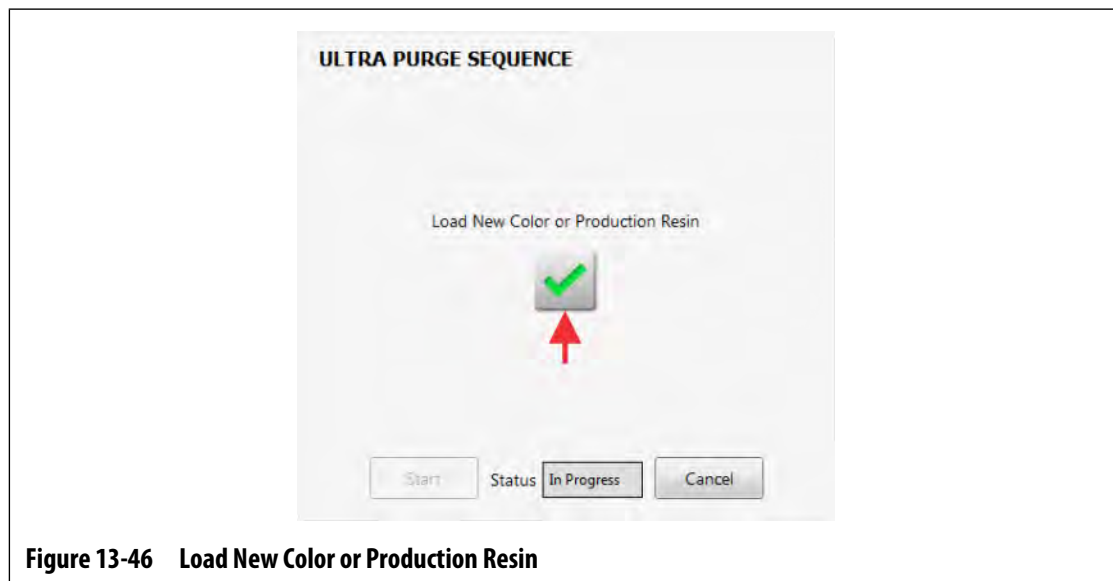


Figure 13-45 Ultra Purge Soak Time Completes

13. Load the new production resin into the IMM (Figure 13-46).



14. Continue to do short injection shots with the Ultra Purge.

NOTE: This helps flush the Ultra Purge and bring the new production resin to the hot runners.

15. Touch the green check mark when injection shots contain the new production resin (refer to Figure 13-47).

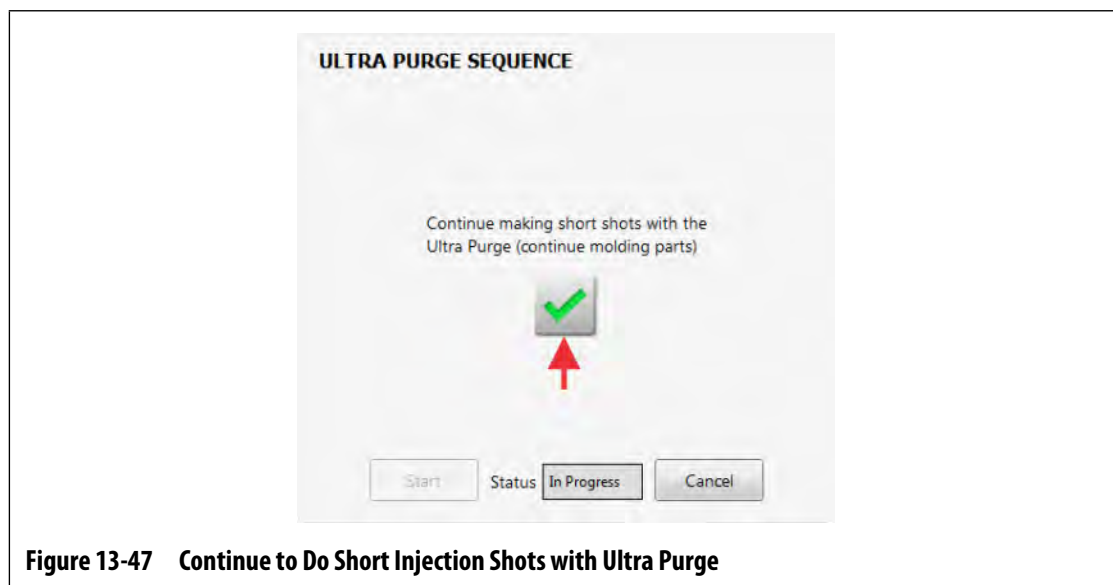


Figure 13-47 Continue to Do Short Injection Shots with Ultra Purge

- 16. Let the controller count parts until it gets to twice the Ultra Purge amount, and then touch the green check mark button (Figure 13-48).

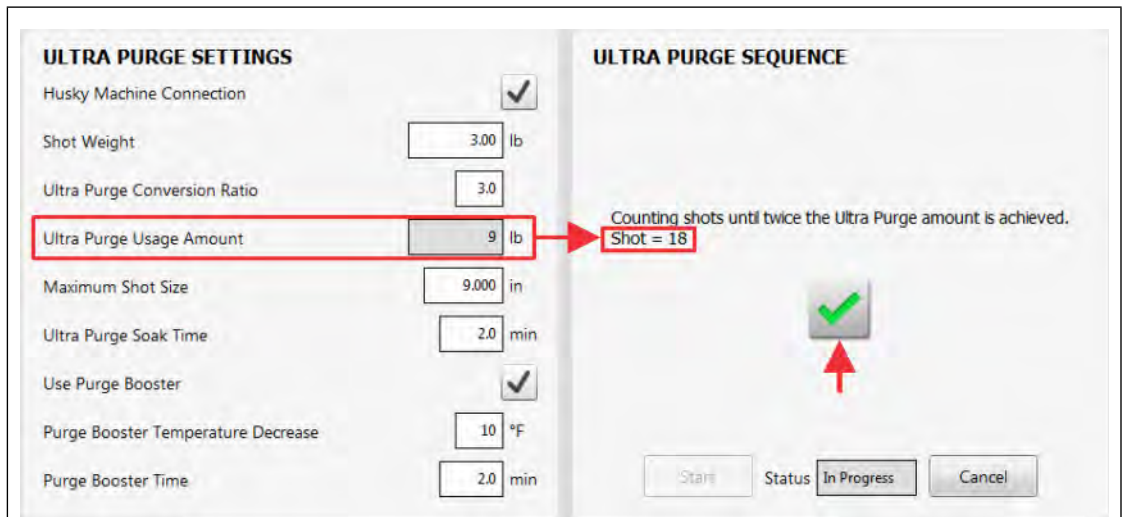


Figure 13-48 Count Parts until Twice the Ultra Purge Amount

- 17. Touch the green check mark button to confirm that the purging has completed (Figure 13-49).

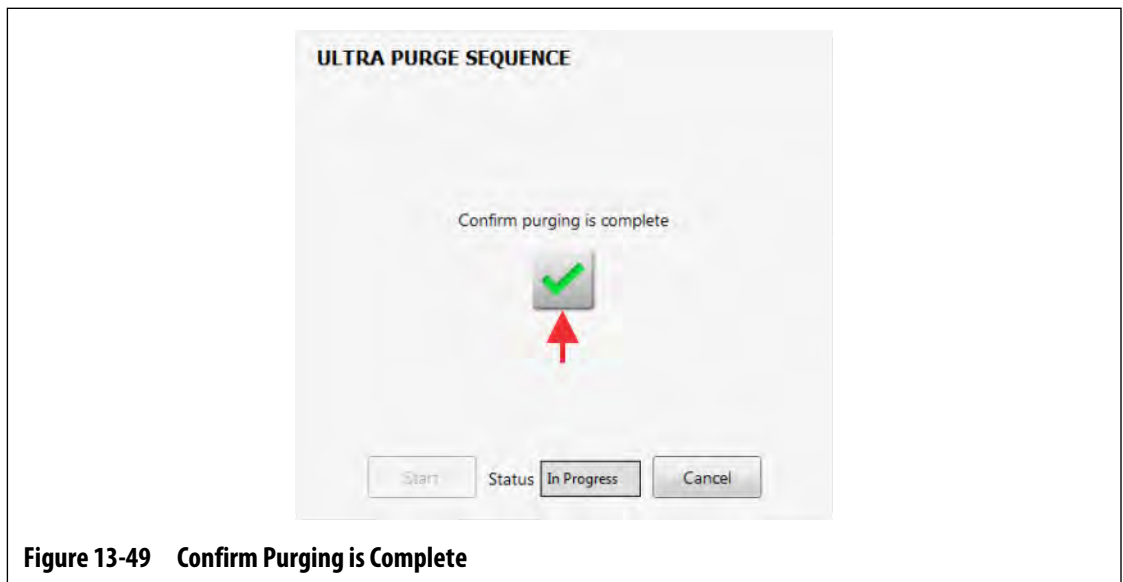


Figure 13-49 Confirm Purging is Complete

18. Adjust the hot runner temperature to x °F (x °C) below the normal setpoint (refer to Figure 13-50).
19. Touch the **Start Purge Booster** button.

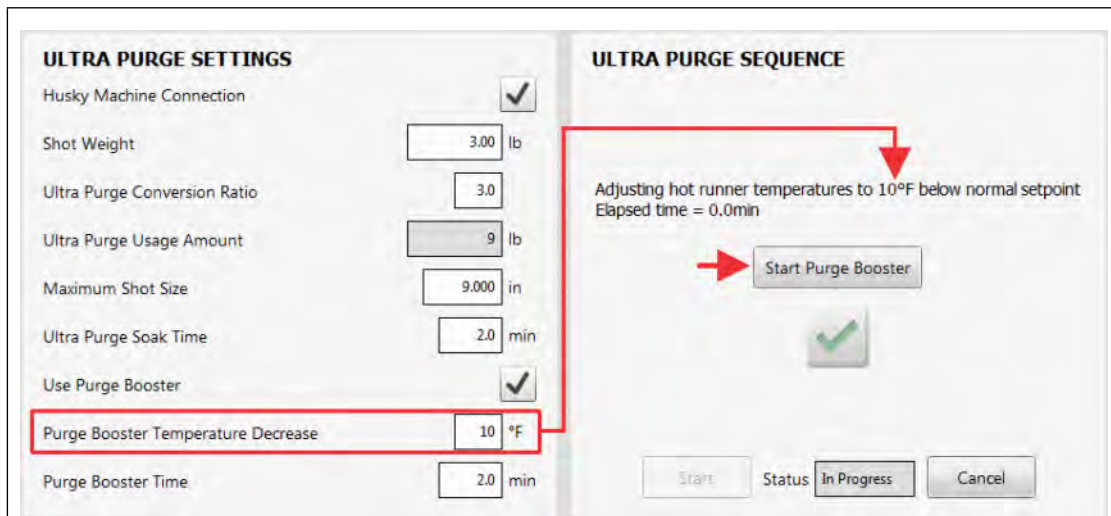


Figure 13-50 Adjust Hot Runner Temperature and Start Purge Booster

20. When the Purge Time completes, touch the green check mark button to continue (refer to Figure 13-51.)

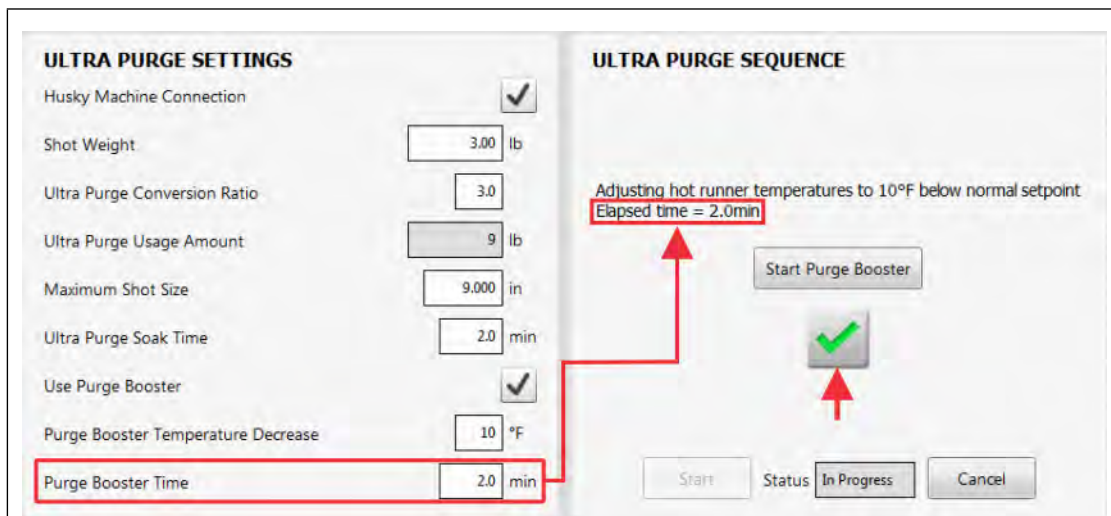


Figure 13-51 Purge Booster Time Completes

- 21. Adjust the hot runners' temperatures to their operational parameters.
- 22. When the temperatures are at their parameter settings, touch the green check mark button to continue (refer to [Figure 13-52](#)).

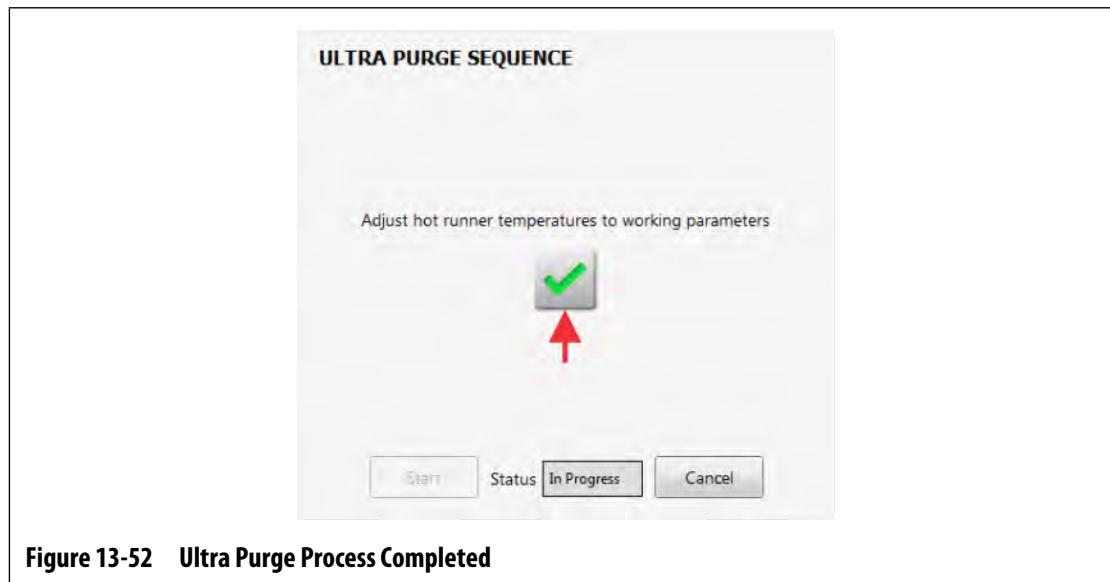


Figure 13-52 Ultra Purge Process Completed

- 23. Touch the green check mark button to complete the Ultra Purge process ([Figure 13-53](#)). You can start production with the new resin.

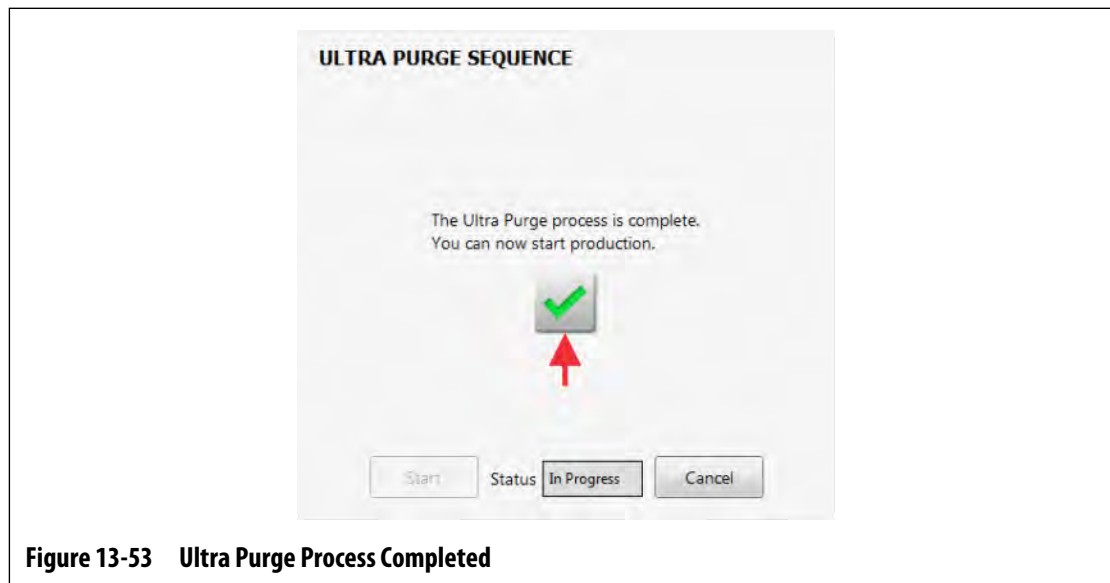


Figure 13-53 Ultra Purge Process Completed

Chapter 14 System Options

The Altanium controller has many additional optional features available to help in the molding process. There are hardware, software, and a combination of hardware and software options that can be used to maximize the system.

14.1 Digital I/O

Use the I/O screen to configure the digital inputs and outputs. On the Home screen, touch the **I/O** button.

The I/O options are divided into four categories:

- Safety
- Digital Inputs
- Digital Outputs
- Configurable Signals

The tabs at the bottom of the screen are used to access each I/O category. [Table 14-1](#) gives a list of items found on the I/O screens with their descriptions.

To configure the I/O, select a tab for safety, inputs, outputs, or configurable signals to see the I/O you want. If your Altanium controller has heats and/or servos installed, the digital inputs and outputs screens will show sub-tabs related to those features. Navigate to the I/O and configure the settings as necessary to the requirements.

Table 14-1 Digital I/O Screen Item Descriptions

Item	Description
Name	The name of the input and output option.
Function	A description of the input or output option.
Active	Indicates if the feature is active (green) or inactive (grey).
Invert	Used to manually invert the I/O condition that it is in at this time.
In Use	Used to set the I/O heats options On or Off.
Level	Indicates (green) if there is a signal at the physical hardware pins.
Schematic	Relates to the input or output number assigned to the option.
Pins	The connector pins related to each input and output.

14.1.1 Enable an I/O Option

The system comes standard with the ability to configure up to four I/O heats options. If an option package is included with the system, the options must be enabled. The system only lets you enable the number of purchased options. To enable a different option when the system is at the purchase limit, disable one of the options and then enable a different option.

To enable an option, touch the **In Use** checkbox for the option. A check mark shows if the option is on.

To disable an option, touch the check mark in the **In Use** checkbox to clear it.

14.2 Safety Signals (UltraSync-E or Altanium Servo Control Installed)

The safety signals are monitored to make sure the system does not continue to operate in an unsafe condition. These are locked signals, so you cannot modify the name, invert the signal, or force the signal.

These signals are only available when the controller is configured with UltraSync-E or Altanium Servo Control.

[Table 14-2](#) describes the safety signals.

Table 14-2 Safety Signals

Signal	Description
IMM E-Stop OK	This signal from the IMM tells the Delta5 system that the IMM E-Stop is in correct operation. If an IMM E-Stop button is pushed, the indicator would not be illuminated.
IMM Safety Gates Closed	This signal from the IMM tells the Delta5 system that all of the IMM safety gates are closed. If an IMM safety gate is open, the indicator would not be illuminated.
Controller E-Stop OK	This signal shows the Delta5 system E-Stop is in correct operation. If there was a problem with the E-Stop function, the indicator would not be illuminated.
Bench Mode Plug Installed	This indicator is for Husky Technical Support only.

14.3 Digital Inputs

Use the Digital Inputs screens to set the digital input signals from the IMM. There are two sets of input screens that you can configure. Tabs at the bottom of the screen give you access to digital inputs that follow:

- Servo
- Heats (Page 1 and 2)

If your Delta5 system operates an UltraSync-E, Valve Gate Sequencer, or some other Husky injection product, one or more tabs will show to configure the inputs from those products. Refer to the user guide for that product for information about the digital input signals.

The sections that follow describe the Digital Inputs screens.

14.3.1 Servo Digital Inputs

There are 10 servo digital inputs. For Delta5 systems with UltraSync-E, Husky sets the input signals that follow to digital inputs 1 through 5. These input signals can be changed to agree with customer IMM configurations and operations.

- IMM in Auto
- External At Temperature
- UltraSync-E Valve Gates Open Command
- UltraSync-E Valve Gates Close Command
- External Permit Calibration

Servo digital inputs 6 through 10 can be configured as necessary for your controller.

Touch the **Digital Inputs** tab on the I/O screen and then touch the **Servo** tab to see the Servo Inputs. Refer to [Figure 14-1](#).



Figure 14-1 Servo Digital Inputs Screen

A list of the usual input signals from the IMM is shown in [Table 14-3](#).

Table 14-3 Servo Digital Input Signals from the IMM

Signal	Description
IMM In Auto	This signal is TRUE when the IMM is in automatic cycle mode. When the IMM is in automatic cycle mode, the servos cannot change from Engaged mode. This prevents accidental cycle stops.
External At Temperature	This signal is TRUE when all heat zones are within their specified tolerance range.
Valve Gates Open Command	This signal is used to start the Valve Gates Open operation.
Valve Gates Close Command	This signal is used to start the Valve Gates Close operation.
External Permit Calibration	This signal must be TRUE to start valve stem calibration. If this signal lost (not TRUE) during calibration, the calibration sequence is cancelled. This prevents calibration when damage can occur, such as when the mold is closed with parts in the cavities.

For Servo Digital Inputs, you have the options to Invert the input signal and to use Force to set the signal state to:

- None
- Low
- High

14.3.2 Heats Digital Inputs

The Heats tabs (Heats Page 1 and Heats Page 2) show screens with the digital inputs from the IMM that are related to heats operation. Refer to [Figure 14-2](#).



Figure 14-2 Digital Inputs Screen (Heats Page 1)

Table 14-4 describes the input signals on the Heats Page 1 screen.

Table 14-4 Heats Input Signals (Heats Page 1)

Signal	Description
Remote Standby	Puts all zones that have a Remote Standby setpoint into Standby mode (Lower setpoint) when this input signal is activated.
Remote Boost	Puts all zones that have a Remote Boost setpoint into the Boost mode (Higher setpoint) when this input signal is activated.
Remote Start	Puts the system in Start mode when this signal is remotely activated. This stays in the state until the STOP key is selected or Remote Stop is activated.
Remote Stop	Puts the system in Stop mode when this signal is remotely activated. This stays in the state until the START key is selected or Remote Start is activated. NOTE: The system cannot be started when this input is active
Manual Boost	Puts all zones that have a Manual Boost setpoint set into Boost mode (Higher setpoint) when this input signal is activated. NOTE: This is the same as if an operator touched the boost key in the operator interface.
Cooling Lines Not Enabled	Shows the warning message 'Mold Cooling Lines are not Enabled' on the screen until the signal has been deactivated. This signal should come from a thermolator. NOTE: If the thermolator is switched off (input signal active), the warning message is shown.
Cycle Input	Gives a Start or End of Cycle signal from the injection molding machine. This input can be configured as the trigger to log process data on Altanium systems that are configured for hot runner temperature control. NOTE: This should be connected to a cyclical signal (the signal goes HIGH to LOW during each injection cycle).
Reset Parts Counter	When activated, this signal will reset the 'Parts In Sack' value in the Part Counting setup dialog and the Part value in the system header to zero. NOTE: This is a paid option and is separate from the standard I/O package options.
Count Parts	When activated, this signal will increase the 'Parts In Sack' quantity value in the Part Counting setup dialog and the Part value in the system header based on the number of heat zones that satisfy the Part Count conditions. NOTE: This is a paid option and is separate from the standard I/O package options.

Table 14-5 describes the input signals on the Heats Page 2 screen.

Table 14-5 Heats Input Signals (Heats Page 2)

Signal	Description
Load Setup	When activated, this signal will initiate the remote load request and a new mold setup will be loaded by the system based on the ID determined by the inputs assigned to Bits 0 - 9. NOTE: This is a paid option and is separate from the standard I/O package options.
Setup Bit 0-9	When activated, these signals create a binary ID that is assigned to the related mold setup in the Remote Load Setup dialog. If the system is configured for the 8- or 10-bit remote load options, the number of Setup Bits will increase to 8 and 10 respectively. NOTE: This is a paid option and is separate from the standard I/O package options.

14.4 Digital Outputs

Use the Digital Outputs screens to set the digital output signals to the IMM. There are two sets of output screens that you can configure. Tabs at the bottom of the screen give you access to the digital outputs that follow:

- Servo
- Heats (Page 1 and 2)

If your Delta5 system operates an UltraSync-E, Valve Gate Sequencer, or some other Husky injection product, one or more tabs will show to configure the outputs to those products. Refer to the user guide for that product for information about the digital output signals.

The sections that follow describe the Digital Outputs screens.

14.4.1 Servo Digital Outputs

Touch the **Servo** tab on the I/O screen to see the servo digital outputs to the IMM. Refer to [Figure 14-3](#).

You can configure up to 7 digital outputs. You can give each signal a name and identify the connector and pin number in which the output signal is supplied. Touch the field under the **Name** and/or **Pins** columns to enter the signal name and/or the output connector pin.

When necessary, an output signal can be set (forced) to always be high or low, so the system will ignore the true signal status. Touch the field in the **Force** column for a signal and select High, Low, or None:

- When Force is set to 'High', the signal level at the pin is always high.
- When Force is set to 'Low', the signal level at the pin is always low.
- When Force is set to 'None' (default), the signal level at the pin is not forced.

NOTE: The Invert override is not related to the force High or Low settings, so the checkbox does not have an effect on the signal. The Invert override operates when Force is set to None.



Figure 14-3 Servo Digital Outputs Signals Screen

A list of the usual output signals to the IMM is shown in [Table 14-6](#). For Delta5 with UltraSync-E systems, Husky sets these output signals to digital outputs 1-4. These output signals can be changed to agree with customer IMM configurations and operations.

Table 14-6 Output Signals to the IMM (with UltraSync-E)

Signal	Description
Fault Stop Immediate	These contacts are closed when the IMM must stop immediately, because of a fault or alarm on the controller. This signal can be used to tell the IMM when clamp movement is permitted.
UltraSync-E Ready and Engaged	This signal is ON when the controller is in automatic/Engaged mode with no faults.

Table 14-6 Output Signals to the IMM (with UltraSync-E) (Continued)

Signal	Description
UltraSync-E Stems At Open	<p>This signal tells the IMM that the valve gates are at the Open position. The At-Open output signal is ON when all of the conditions that follow are TRUE:</p> <ul style="list-style-type: none"> • Movement to the Open position is complete (applicable when the At-Position Only When Command Completes is selected) • No movement on the plate • Open position is within the At Position tolerance • If installed, the UltraSync-E drive has completed calibration, there are no faults, and is prepared to operate <p>If one of these conditions is no longer TRUE, the At-Open signal changes to OFF.</p> <p>This signal can be used to tell the IMM that injection is permitted.</p>
UltraSync-E Stems At Closed	<p>This signal tells the IMM that the valve gates are at the Closed position. The At-Closed output signal is ON when all of the conditions the follow are TRUE:</p> <ul style="list-style-type: none"> • Movement to the Closed position is complete (applicable when the At-Position Only When Command Completes is selected) • No movement on the plate • Closed position is within the At Position tolerance • If installed, the UltraSync-E drive has completed calibration, there are no faults, and is prepared to operate <p>If one of these conditions is no longer TRUE, the At-Closed signal changes to OFF.</p>

Table 14-7 shows other Servo outputs from which you can select.

Table 14-7 Servo Digital Output Selections

Signal Type	Signal	Condition	Position
None	-	-	-
Digital Input	<p>Digital Input 1 - 10</p> <p>The first five digital inputs may be factory set for the features installed on your controller, as shown here:</p> <ul style="list-style-type: none"> • IMM In Auto • External At Temperature • UltraSync-E Stems Open Command • UltraSync-E Stems Close Command • External Permit Calibration 	-	-

Table 14-7 Servo Digital Output Selections (Continued)

Signal Type	Signal	Condition	Position
Controller Function	<ul style="list-style-type: none"> Fault Stop Immediately Fault Stop End Of Cycle Calibration Active Process Outside Limit All Axes At Standstill 	-	-
Configurable Signal	Configurable signal 1 - 24	-	-
UltraSync-E (if installed)	<ul style="list-style-type: none"> UltraSync-E Stems At Closed UltraSync-E Stems At Open UltraSync-E Ready and Engaged UltraSync-E Stems Position 	-	-
Temperature Control	At Temperature	-	-

14.4.2 Heats Digital Outputs

The Heats tabs (Heats Page 1 and Heats Page 1) show screens with the digital outputs to the IMM that are related to heats operation. Refer to [Figure 14-4](#).

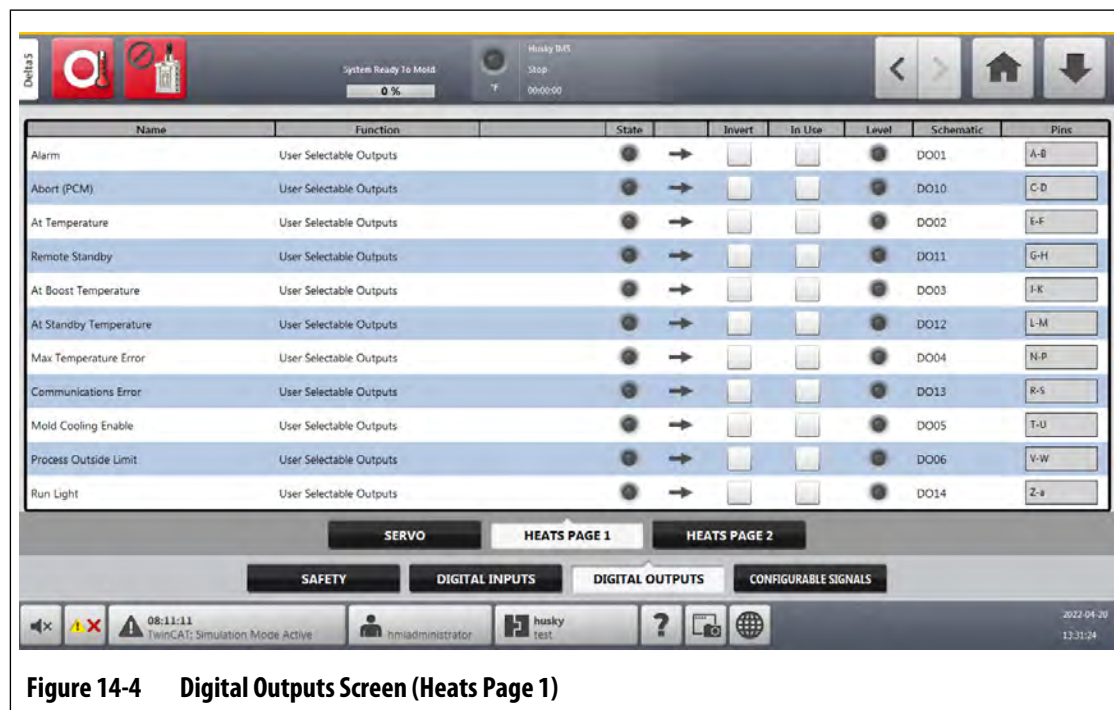


Figure 14-4 Digital Outputs Screen (Heats Page 1)

Table 14-8 describes the heats output signals on the Heat Page 1 tab.

Table 14-8 Heats Output Signals (Heats Page 1)

Signal	Description
Alarm	Activated when an Alarm or Abort condition occurs. This state stays until the alarm condition is CLEARED or RESET.
Abort (PCM)	Activated when an Abort condition occurs, and the Priority Control Mode (PCM) setting in the Quick Set screen is set to System. This state stays until the alarm condition is CLEARED or RESET.
At Temperature	Activated only when all zones are above their Under Temperature alarm limit. This state stays until a zone drops below its Under Temperature alarm limit or the controller is put into Stop mode.
Remote Standby	Activated when the controller has received the Remote Standby input signal.
At Boost Temperature	Activated only when all zones with a Remote Boost setpoint are above their Under Temperature alarm limit while in BOOST mode. This state stays until a zone drops below its Under Temperature alarm limit or the controller is put into Stop mode. NOTE: If one or more zones go above the Over Temperature alarm limit the state will stay.
At Standby Temperature	Activated only when all zones with a Remote Standby setpoint are above their Under Temperature alarm limit while in Standby mode. This state stays until a zone drops below its under temperature alarm limit or the controller is put into Stop mode. NOTE: If one or more zones go above the Over Temperature alarm limit the state will stay.
Max Temperature Error	Activated when one or more zones exceed the Over Maximum Temperature limit.
Communications Error	Activated if the controller stops communicating with a control card. This state stays until communications are in operation again.
Mold Cooling Enable	Activated when all temperatures are greater than the Mold Cooling Enabled Limit. NOTE: All temperatures must be equal to or lower than the Mold Cooling Enabled Limit before the signal is deactivated, after the system is in STOP mode.
Process Outside Limit	Activated if any critical process parameter violates its threshold setting. NOTE: The threshold setting is in the Process Monitoring - Limits screen.
Run Light	Activated whenever the START button is pressed. This state stays until the system is placed in STOP mode.

Table 14-9 describes the heats output signals on the Heat Page 2 tab.

Table 14-9 Heats Output Signals (Heats Page 2)

Signal	Description
Boost Active	Activated when the controller is in Boost mode. This state stays high (regardless if the Boost mode has been canceled or expired) until all zones are under the Upper Alarm limit. This makes sure that all parts molded in this time frame will be declared scrap and diverted to a scrap container. NOTE: The feature operates in Manual and Remote Boost modes.
Sack Full	Activated when the Part Counter reaches the 'Sack Full' limit value. The signal will reset anytime the Part Counter is reset. NOTE: This is a paid option and is separate from the standard I/O package options.
Remote File Loaded	Activated when the mold setup file has been correctly loaded to the system. NOTE: This is a paid option and is separate from the standard I/O package options.

14.5 Configurable Signals (UltraSync-E, Altanium Servo Control, or Valve Gate Sequencer Installed)

Configurable signals are outputs that use Boolean logic. You can use input functions, output functions, and other adjustable signals as conditions for a specified adjustable signal that when all are TRUE the specified signal is ON.

These signals are only available when the controller is configured with UltraSync-E, Altanium Servo Control, or Valve Gate Sequencer Control.

Touch the **Configurable Signals** tab to see the Configurable Signals screen. Refer to [Figure 14-5](#).

The tabs at the bottom of the Configurable Signals screen give access to the signals. There are two configurable signals on each tab.

One to four conditions can be set for each configurable signal. Use the Logic Function and Force (if necessary) to set how the configurable signal will operate.



Figure 14-5 Configurable Signals Screen

The three tabs at the bottom of the Configurable Signals screen give access to the signals. There are two configurable signals on each tab.

14.5.1 Logic Function

When set to AND, the configurable signal is TRUE only when all conditions are TRUE. When set to OR, the configurable signal is TRUE when one or more conditions are TRUE.

When set to LATCHING, a configurable signal is TRUE when a specified event occurs. The signal stays TRUE until another event sets it FALSE.

When the LATCHING logic function is selected, each condition row will show a Latch action that you can set to Latch or Unlatch.

When a condition row is TRUE, one of the Latch actions that follows occurs:

- If set to Latch, the configurable signal is set to TRUE.
- If set to Unlatch, the configurable signal is set to FALSE.

The configurable signal then stays in this state until a different condition row changes it.

A configurable signal with more than one condition is evaluated in the order that the conditions are listed, top to bottom. Thus, it is possible that the configurable signal becomes latched and then unlatched at the same time. The final signal (TRUE or FALSE) is set by the last action that was evaluated.

14.5.2 Force

You can force a configurable signal High or Low (TRUE or FALSE). This will override all of the condition settings that are configured for a signal.

When Force is set to None, the signal operates by the configured conditions.

When Force is set to Low, the configured conditions are ignored and the signal stays low (FALSE).

When Force is set to High, the configured conditions are ignored and the signal stays High (TRUE). The Active indicator illuminates.

This setting can be used to manually force a signal to High or Low when a signal's status must stay in one state for an operation. This helps when you initially configure other signals for an operation that would be triggered from the forced signal. Also, you can use Force to bypass specific signals when troubleshooting.

14.5.3 Conditions

Four conditions are available for each configurable signal. Touch the **Signal Type** field next to each condition you want to set. You can select from the signal types that follow:

- Digital Input
- Controller Functions
- Configurable Signal
- A Husky control technology installed on your Altanium system, such as UltraSync-E
- Safety Signal
- Temperature Control

With each signal type, there can be related signal sources, conditions, and values that must be set. Configure these as necessary.

14.6 Cable Connections

All cables are connected to the bottom of the Delta5 MCU, with the exception of the USB connections on the front of the MCU. The USB connections are used for importing and exporting data.

The insulation level of control cables and devices connected to Delta5 I/O's are as follows:

- 500 V when the devices are powered by a 400 VAC or 415 VAC system
- 300 V when the devices are powered by a system up to 240 VAC

NOTE: When the 12 V provided on Input, Part Count, or Remote Load connectors is connected to external devices, the total current used by all external devices shall not exceed 1 A.

Figure 14-6 shows the Delta5 connector locations. The connectors are described in Table 14-10.

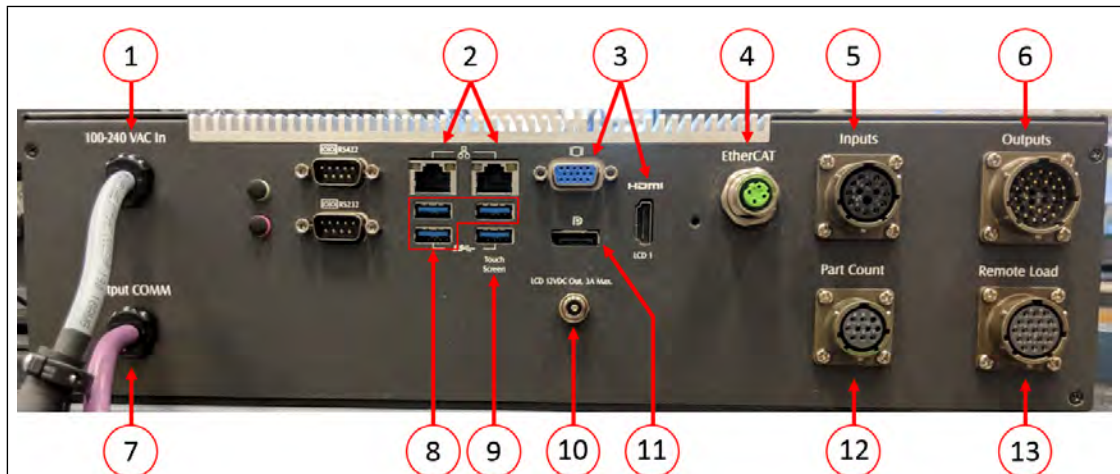


Figure 14-6 Delta5 Connectors, Typical

Table 14-10 Delta5 Connector Identification

Item	Cable Connection	Description
1	100-240 VAC In	Main AC power from the Altanium mainframe.
2	Ethernet	Interface to customer networks.
3	HDMI or VGA	Video signal to touch monitor. NOTE: Some systems with motion (servo) control will utilize the VGA connector.
4	EtherCAT, if equipped	Communication to UltraSync-E Gen2, Altanium Servo Control, Individual Servo Valve Gate, or Valve Gate Sequencer systems.
5	Inputs, if equipped	Configurable digital inputs.
6	Outputs, if equipped	Configurable digital outputs.
7	Output COMM	CANBus communication to Altanium mainframe.
8	USB Ports	Touchscreen signal to secondary touch monitor. NOTE: Only used if controller was ordered with this option.
9	Touch Screen	Touch screen signal to the primary touch monitor.
10	LCD 12 VDC Out	Power to the primary touch monitor.
11	Display Port	Video signal to secondary touch monitor. NOTE: Only used if the controller was ordered with this option.
12	Part Count, if equipped	Part count option signals.
13	Remote Load, if equipped	Remote load option signals.

14.7 Input/Output Connector Pin-Out Description

The sub-sections that follow give the connection details for all of the optional inputs and output signals. Inputs are active High (12 VDC with a maximum current rating of 1 A). All outputs are a dry contact relay type.

14.7.1 Input Base Connector ID

The input connector pins are identified in [Table 14-11](#).

Table 14-11 Input Base Connector Pins

Connector/Pin	Field Cable Wire Color	Signal Function
Input / A	WHT	Remote standby
Input / B	WHT/BLK	Remote boost
Input / C	BLK	Remote start
Input / D	BLK/WHT	Cooling lines not enabled
Input / E	BLU	Manual boost
Input / F	BLU/WHT	Remote Stop
Input / G	BLU/BLK	12 V+
Input / H	GRN	12 V+
Input / J	GRN/BLK	0 V
Input / K	GRN/WHT	0 V
Input / L	ORG	Cycle Input

14.7.2 Output Base Connector ID

The maximum loads on the digital outputs are as follows:

- 110 VDC / 0.3 A - 33 W
- 30 VDC / 2.0 A - 60 W
- 120 VAC / 0.5 A - 60 VA
- 240 VAC / 0.25 A - 60 VA

The output connector pins are identified in [Table 14-12](#).

Table 14-12 Output Base Connector Pins

Connector/Pin	Field Cable Wire Color	Signal Function
Output / A	GRN	Alarm
Output / B	ORG/GRN	Alarm

Table 14-12 Output Base Connector Pins (Continued)

Connector/Pin	Field Cable Wire Color	Signal Function
Output / C	RED	Abort (PCM)
Output / D	BLU/RED	Abort (PCM)
Output / E	ORG	At temperature
Output / F	ORG/BLK	At temperature
Output / G	BLK	Remote standby
Output / H	BLU/BLK	Remote standby
Output / J	WHT	At boost temperature
Output / K	BLU/WHT	At boost temperature
Output / L	RED/GRN	At standby temperature
Output / M	ORG/RED	At standby temperature
Output / N	BLK/WHT	Maximum temperature error
Output / P	WHT/BLK	Maximum temperature error
Output / R	GRN/WHT	Communications error
Output / S	BLK/RED/WHT	Communications error
Output / T	BLK/RED	Mold cooling enable
Output / U	RED/BLK	Mold cooling enable
Output / V	RED/WHT	Process outside limit
Output / W	WHT/RED	Process outside limit
Output / X	GRN/BLK	Boost Active
Output / Y	GRN/BLK/WHT	Boost Active
Output / Z	WHT/RED/BLK	“Run light”
Output / a	RED/BLK/WHT	“Run light”

14.7.3 Part Count Base Connector ID

The part count base connector pins are identified in [Table 14-13](#).

Table 14-13 Part Count Base Connector Pins

Connector/Pin	Field Cable Wire Color	Signal Function
Part Count / A	BLK	Reset parts counter
Part Count / B	WHT	Count Parts
Part Count / C	RED	12 V+
Part Count / D	GRN	0 V
Part Count / E	BRN	Sack full
Part Count / F	BLU	Sack full

14.7.4 Remote Load Base Connector ID

The remote load base connector pins are identified in [Table 14-14](#).

Table 14-14 Remote Load Base Connector Pins

Connector/Pin	Field Cable Wire Color	Signal Function
Remote Load / A	WHT	Load setup
Remote Load / B	WHT/BLK	Setup B0
Remote Load / C	BLK	Setup B1
Remote Load / D	BLK/WHT	Setup B2
Remote Load / E	BLU	Setup B3
Remote Load / F	BLU/WHT	Setup B4
Remote Load / G	BLU/BLK	Setup B5
Remote Load / H	GRN	12 V+
Remote Load / J	GRN/BLK	12 V+
Remote Load / K	GRN/WHT	0 V
Remote Load / L	ORG	0 V
Remote Load / M	ORG/BLK	Remote file loaded
Remote Load / N	RED	Remote file loaded

Chapter 15 SPI Protocol Option

The Altanium controller communicates with central networks or molding machines that support the Society of Plastics Industry (SPI) standard protocol.

The system takes the device ID of 26h on the SPI communications channel. This ID has been assigned to general-purpose temperature controllers with multiple zones. The system supports a subset of the commands that have been defined for this ID. The commands for this ID that are not supported by the system do not have equivalent functions in the system.

15.1 SPI Command Summary

The SPI commands supported by the system are listed below. The system supports the defined poll and select functions for each command. If a selected command is made to all zones in the system, the error requirements must be satisfied for every zone before an ACK is returned.

- Echo
- Version
- Process Setpoint 1
- Process Value
- Alarm Active Status
- Alarm 1 Setpoint
- Alarm 2 Setpoint
- Alarm 1 Reset
- Controller Status
- Manual Percentage Output
- Open/Close Loop Control

15.1.1 Echo

Summary	SPI controller integrity command.
Errors	If the data length for the selected function is incorrect, the system will return a Negative Acknowledge (NAK).
Version Summary	The system transmits the device ID (26h) and SPI software version number.
Errors	None.

15.1.2 Process Setpoint

Summary	This command is used to set and read the temperature setpoint for an automatically controlled zone. It is valid even if the selected zone is running in MANUAL or VIEW regulation mode.
Errors	<p>The conditions that follow give a NAK response with an invalid data error for the select function:</p> <ul style="list-style-type: none"> • Incorrect data length • Invalid zone number • A value less than the minimum setpoint • A value more than the maximum setpoint <p>An invalid zone number condition will give an invalid data error in response to a polled function.</p>

15.1.3 Process Value

Summary	This command is used to read the actual temperature of a specified zone. It is valid for zones in all regulation modes. If the zone does not have a thermocouple input or thermocouple type assigned, or if the thermocouple is disconnected, 0.0 is returned. Otherwise, a value between 32 °F and 932 °F is returned.
Errors	An invalid zone number condition will give an invalid data error in response to a polled function.

15.1.4 Alarm Active Status

Summary	This command is used to read an error status for a single zone. A value of 0 is returned if no errors are active. It is valid for all zones in all regulation modes.
Errors	An invalid zone number condition will give an invalid data error in response to a polled function.

15.1.5 Alarm 1 Setpoint

Summary	This command is used to set and read the alarm window value for a single zone. The alarm window is used only for zones with Auto or View regulation.
Errors	<p>The conditions that follow give a NAK response with an invalid data error for the select function:</p> <ul style="list-style-type: none"> • Incorrect data length • Invalid zone number • A value less than 0 °F or greater than 900 °F • A value more than the abort window value <p>An invalid zone number condition will give an invalid data error in response to a polled function.</p>

15.1.6 Alarm 2 Setpoint

Summary	This command is used to set and read the abort window value for a single zone. The abort window is used only for zones with Auto or View regulation.
Errors	<p>The conditions that follow give a NAK response with an invalid data error for the select function:</p> <ul style="list-style-type: none"> • Incorrect data length • Invalid zone number • A value less than 0 °F or greater than 900 °F • A value more than the abort window value <p>An invalid zone number condition will give an invalid data error in response to a polled function.</p>

15.1.7 Alarm 1 Reset

Summary	This command is used to clear the errors for all the zones in the system. The system cannot clear an error for an individual zone.
Errors	<p>The conditions that follow give a NAK response with an invalid data error for the select function:</p> <ul style="list-style-type: none"> • Incorrect data length • Invalid zone number

15.1.8 Controller Status

Summary	This command is used to read the condition of a single zone. The definition of the status bits is given below:		
	BIT	SPI DEFINITION	SYSTEM DEFINITION
	0	Heater Power	Power to heater is not zero
	1	Soft Start	Soft start is active
	2	Manual Control	Manual regulation (Not Auto or View)
	3	Low Alarm 1	Alarm under temperature
	4	High Alarm 1	Alarm over temperature
	5	Low Alarm 2	Abort under temperature
	6	High Alarm 2	Abort over temperature
	7	Open T/C Alarm	Lost thermocouple
	8	Reverse T/C Alarm	Reversed thermocouple
	9	Shorted T/C Alarm	Not supported
	10	Open Output Device	Fuse blown
	11	Shorted Output	Not supported
	12	Ground Fault	Not supported
	13	Low Current Alarm	Not supported
14	High current	Not supported	
15	Out Of Control	Not supported	
Errors	An invalid zone number condition will give an invalid data error in response to a polled function.		

15.1.9 Manual Percent Output

Summary	This command is used to set and read the manual percent output for a manually-regulated zone. It is valid even if the zone is running in the Auto or View regulation mode.
Errors	<p>The conditions that follow give a NAK response with an invalid data error for the selected function:</p> <ul style="list-style-type: none"> • Incorrect data length • Invalid zone number • A value less than the minimum allowed percentage • A value greater than the maximum allowed percentage <p>An invalid zone number condition will give an invalid data error in response to a polled function.</p>

15.1.10 Open/Closed Loop

Summary	This command is used to set the regulation mode of a zone to either Manual or Automatic only. No provision is made to set the regulation to View.
Errors	<p>The conditions that follow give a NAK response with an invalid data error for the selected function:</p> <ul style="list-style-type: none"> • Incorrect data length • Invalid zone number <p>The conditions that follow give an invalid data error in response to a polled function:</p> <ul style="list-style-type: none"> • Invalid zone number. • Zone regulation is set to View.

Chapter 16 Maintenance

This chapter describes the maintenance tasks necessary to maintain the Altanium Delta5 system.

At intervals and before you energize the equipment, do a check of all cables and cable connections to make sure that there is no wear or damage. Do not operate equipment if the cables are damaged. Replace cables that are damaged.

The maintenance procedures that follow can be done only when necessary.

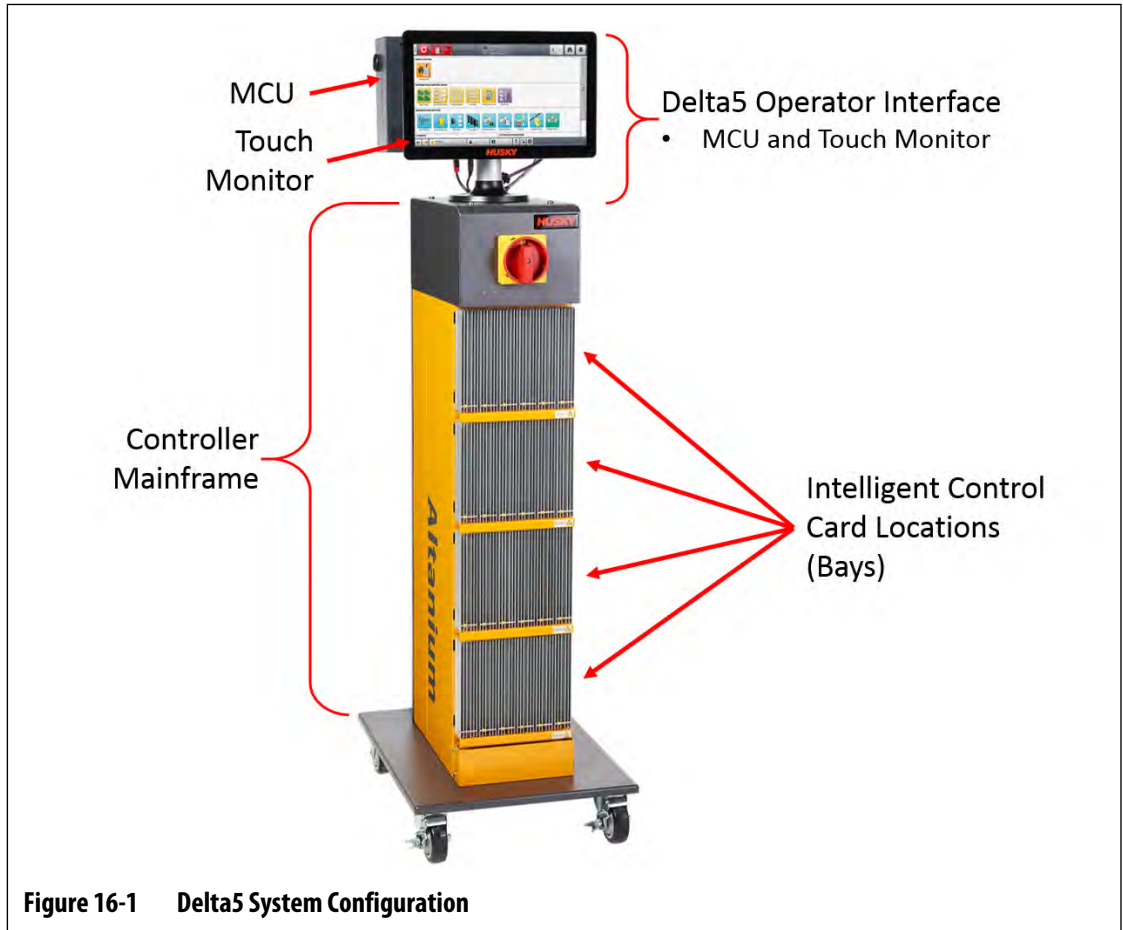
Procedure	Reference
Replace an Intelligent Control Card (ICC ² or ICC ³)	Section 16.3.1
Replace an Open Fuse on an Intelligent Control Card (ICC ² or ICC ³)	Section 16.3.2
Remove and Replace the Touch Monitor	Section 16.4.1
Remove and Replace the MCU	Section 16.4.2
Remove and Replace the Operator Interface	Section 16.4.3
Install the Remote Operator Interface	Section 16.4.4
Install the Alternative Mounted Operator Interface	Section 16.4.5
Install the Dual Touch Monitor	Section 16.4.6
Thermocouple Calibration	Section 16.5
Clean the System	Section 16.6

16.1 Delta5 System

Two primary components of the Delta5 systems are serviceable:

- X-Series or H-Series intelligent control cards (ICC)s
- Delta5 operator interface

The Altanium operator interface display module is used to enter and display molding parameters. Refer to [Figure 16-1](#). Before doing maintenance on the Delta5 system, always de-energize the system at the Altanium main power switch. Refer to [Figure 16-2](#). Do the lock out and tag the Altanium main power switch in accordance with local codes.



WARNING!

Hazardous voltages— risk of death or serious injury. Before servicing the Altanium unit, lock out and tag the Altanium Main Power switch in accordance with local codes.



16.2 Card Layout Screen

The Card Layout screen identifies the cards used in the mainframe, and to which zones each card controls. The Card Layout screen is accessed from the Home screen or the Event History screen.

The backplane layout is on the left side of the screen and the card layout is on the right. Refer to [Figure 16-3](#).

The zone numbers are shown at the top of each card. The zone numbers change with the zone density of the card. If a card is red with no zone numbers, then the card is not installed or an error has occurred with the card. The card types are identified by the color of the card on the screen. XL and HL cards are black, X and H cards are Silver, and XE cards are Green. A red card without a question mark but with zone numbers assigned shows that there is a communication problem or a card is not installed in the slot.

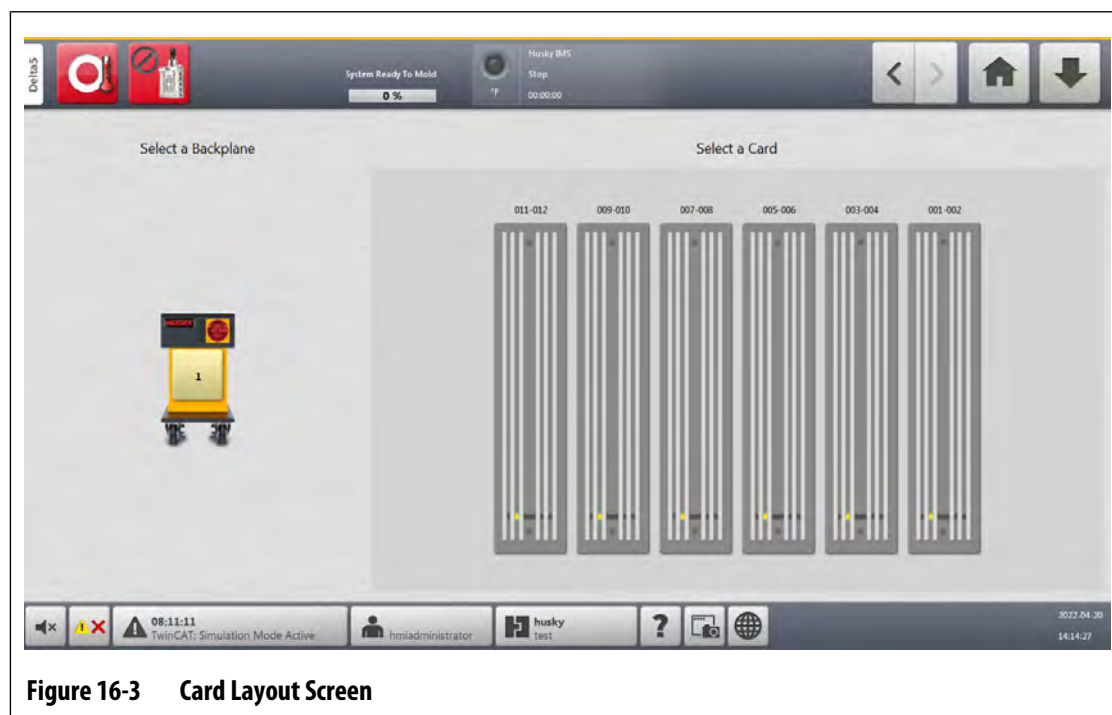


Figure 16-3 Card Layout Screen

16.2.1 Troubleshooting with the Card Layout Screen

The Card Layout screen can be accessed from the Event History screen to identify which card or component on a card is related to an alarm error. For example, to identify an open fuse, do the steps that follow:

1. On the Event History screen, touch the **Filter** button. Refer to [Figure 16-4](#).

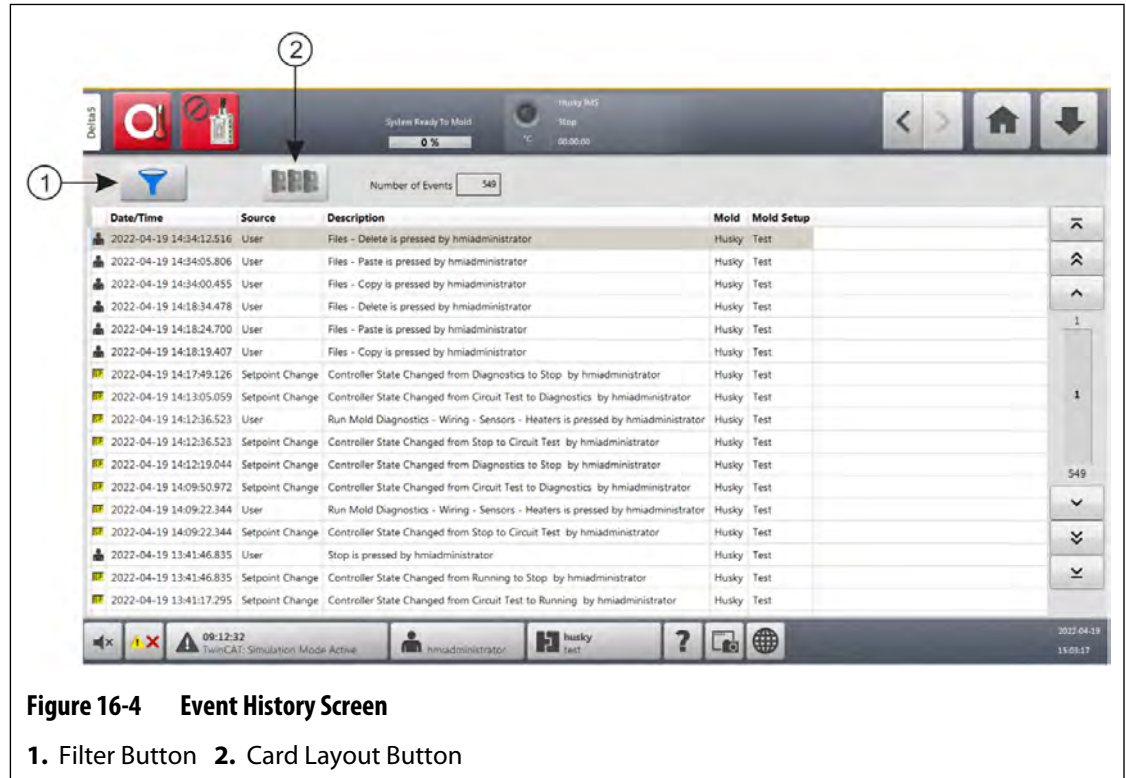


Figure 16-4 Event History Screen

1. Filter Button 2. Card Layout Button

The Event History - Filter dialog window shows. Refer to [Figure 16-5](#).

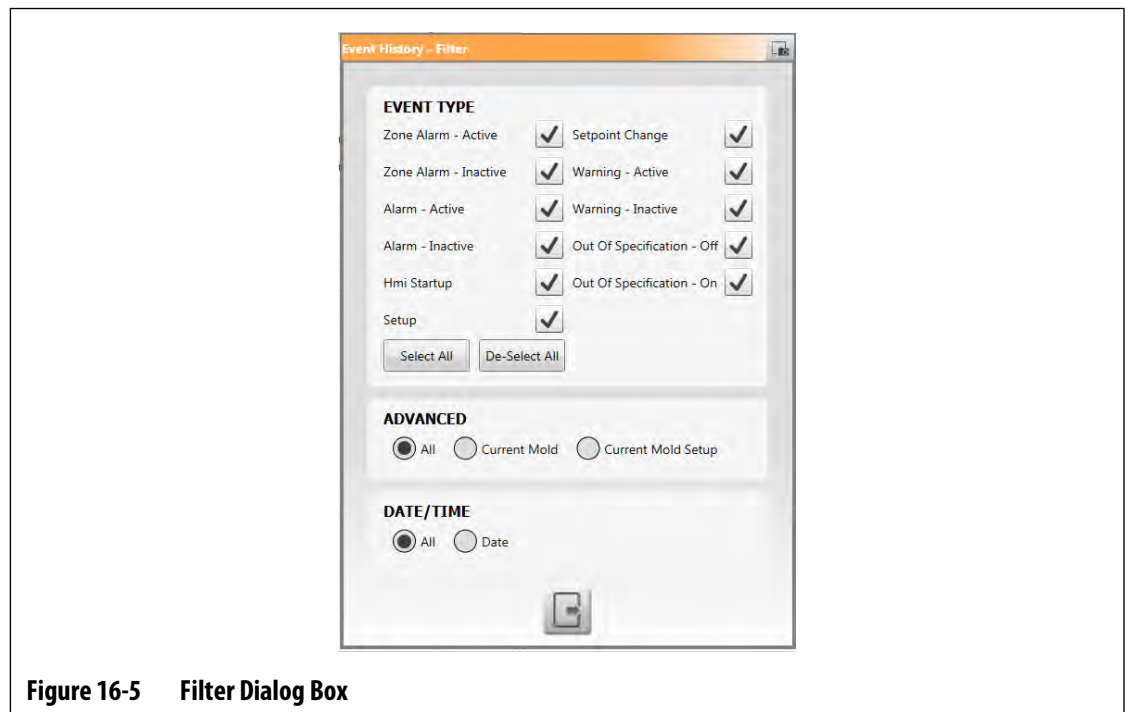


Figure 16-5 Filter Dialog Box

2. Deselect all checkboxes, and then select only the **Zone Alarm Active** and **Zone Alarm Inactive** checkboxes.
3. Touch the **Exit** button.
A list of active and inactive faults is shown.
4. Select the applicable error and then touch the **Card Layout** button.
A screen with the fault information shows. Refer to [Figure 16-6](#).

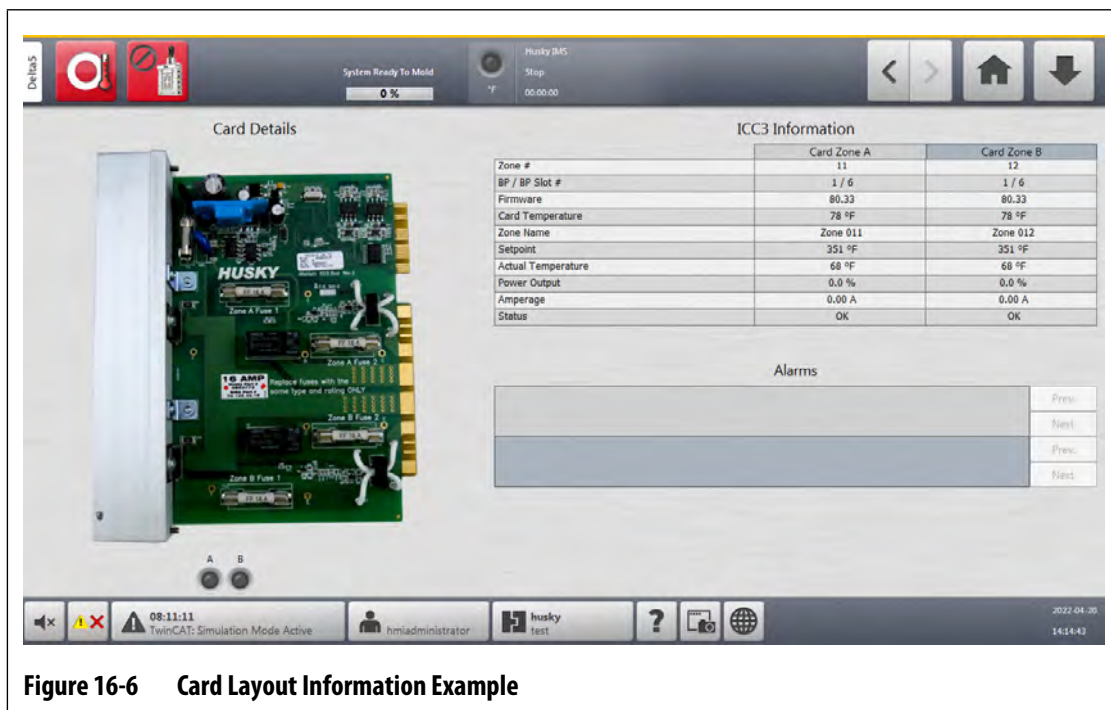


Figure 16-6 Card Layout Information Example

16.3 Intelligent Control Cards

There are two series of intelligent control cards (ICC)s that the Delta5 is designed to work with. These are the X-Series (ICC²) and H-Series intelligent control cards (ICC³). Refer to [Figure 16-7](#) and [Figure 16-8](#). The X-Series card can be identified by the large square blue or brown transformer mounted near the heatsink and is the older generation of Altanium cards. The H-Series card can be identified by the yellow numbered label that indicates how many zones it supports. H-Series cards are the newest generation of Altanium cards.

Although they look similar, the X-Series and H-Series cards are not compatible with each other and must only be used in systems of the same card types.

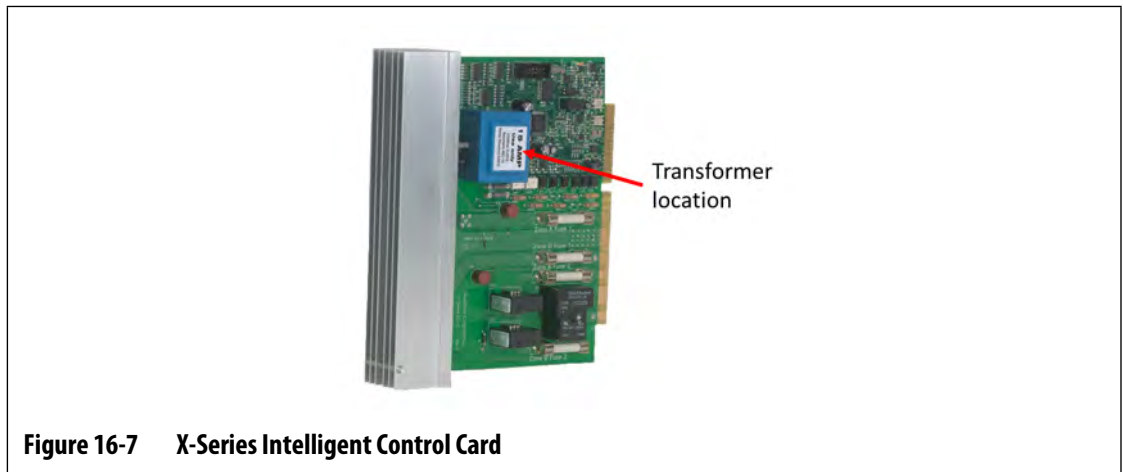


Figure 16-7 X-Series Intelligent Control Card

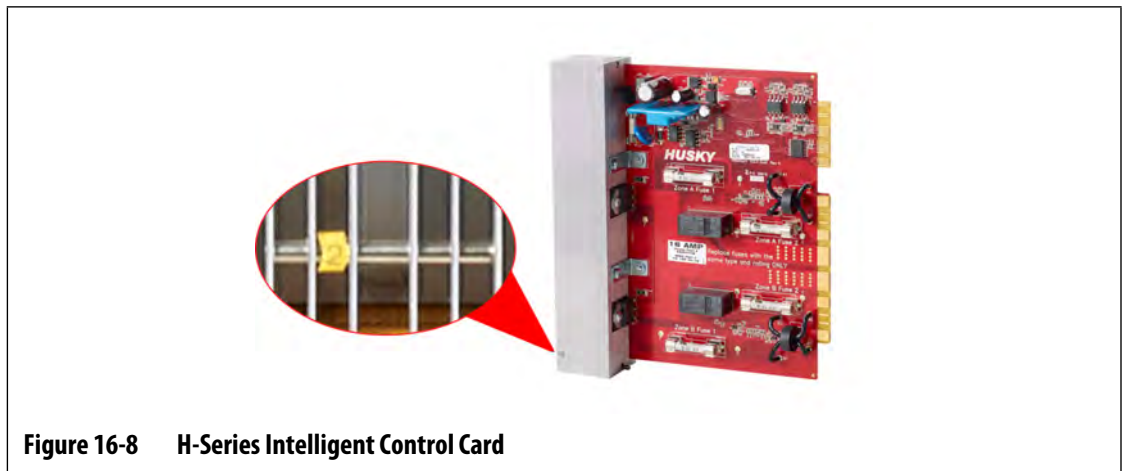


Figure 16-8 H-Series Intelligent Control Card



IMPORTANT!

ICC² and ICC³ cards almost look the same, but they use different backplanes and are not compatible with each other.



IMPORTANT!

An Intelligent Control Card must be installed in the position labeled “1” in all card cages for the system to function correctly.

**WARNING!**

Hazardous voltages— risk of death or serious injury. Before servicing the Altanium unit, lock out and tag the Altanium Main Power switch in accordance with local codes.

Both series of cards plug into backplanes that are installed into the bays of the controller mainframe (Figure 16-9). The cards manage the power being delivered to the heaters, the thermocouple feedback and control and circuit protection.



Position 1

Figure 16-9 Mainframe Bay with Backplane Exposed

16.3.1 Replace an Intelligent Control Card (ICC² or ICC³)



WARNING!

Electrical and mechanical hazard- risk of death, serious injury and/or damage to the equipment. Turn off all power to the system and disconnect it completely from the main input power.

To replace an intelligent control card, do the steps that follow:

1. Find the Card Cage that contains the ICC² or ICC³ that has the fault. Refer to number 1 in [Figure 16-10](#).

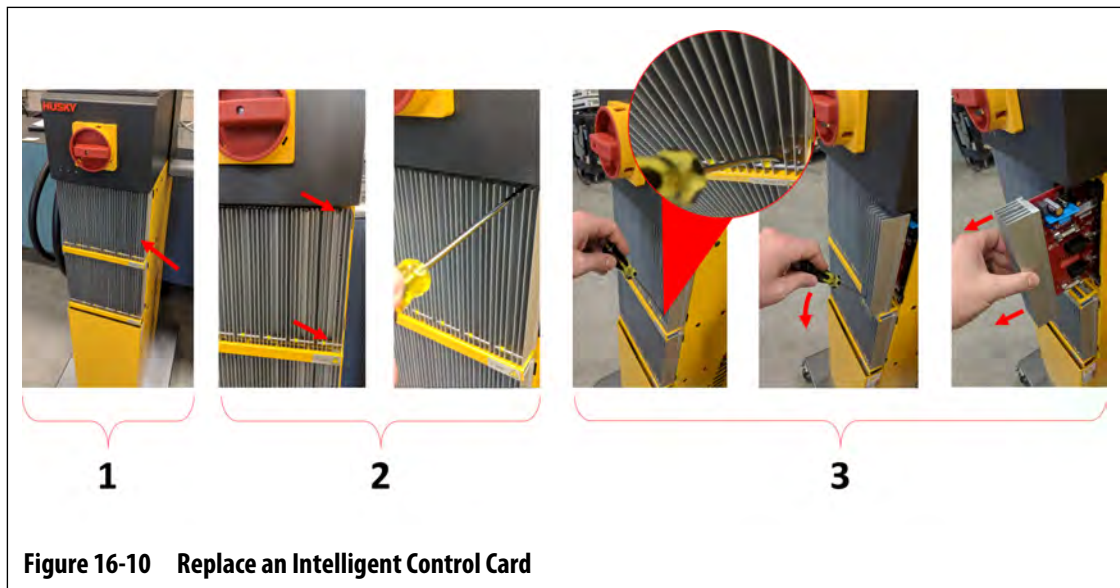
NOTE: You can use the on-screen Card Layout feature to help in find the card.

2. De-energize the system at the Altanium main power switch. Refer to [Figure 16-2](#).
3. Lock out and tag the main power switch in accordance with local codes.

CAUTION!

Mechanical failure mode - attempting to remove a card when the upper and lower heatsink mounting screws are not fully disengaged from the female threads on the cabinet can result in catastrophic damage to the card.

4. Loosen the upper and lower slotted fasteners on the heat sink from the female threads in the cabinet. Refer to number 2 in [Figure 16-10](#).



CAUTION!

The ICC² an ICC³ cards are electrostatic discharge sensitive. Use a ground strap when handling Altanium components.

5. Slide a screwdriver between the silver post and the ledge on the cabinet and gently pry the board out. Refer to number 3 in [Figure 16-10](#).

CAUTION!

Static electricity hazard - risk of damage to the equipment. Do not, under any circumstances, place any PCB on carpets, rugs, or other material that is likely to create a static charge.

6. Carefully place the card on an earthed/grounded surface.
7. Slide the new card into to the slot and push the card slowly and firmly back into place. An incorrectly oriented card will not seat properly.
8. Tighten the upper and lower slotted fasteners on the heat sink.
9. Remove the lock out equipment and tag from the main power switch.
10. Energize the system at the main power switch.

16.3.2 Replace an Open Fuse on an Intelligent Control Card



WARNING!

Electrical and mechanical hazard- risk of death, serious injury and/or damage to the equipment. Turn off all power to the system and disconnect it completely from the main input power.

To replace an open fuse, do the steps that follow:

1. Find the Card Cage that contains the ICC² or ICC³ that has the fault. Refer to number 1 in [Figure 16-10](#).

NOTE: You can use the on-screen Card Layout feature to help in find the card.

2. De-energize the system at the Altanium main power switch. Refer to [Figure 16-2](#).
 3. Lock out and tag the main power switch in accordance with local codes.
-

CAUTION!

Mechanical failure mode - attempting to remove a card when the upper and lower heatsink mounting screws are not fully disengaged from the female threads on the cabinet can result in catastrophic damage to the card.

4. Loosen the upper and lower slotted fasteners on the heat sink from the female threads in the cabinet. Refer to number 2 in [Figure 16-10](#).
-

CAUTION!

The ICC² an ICC³ cards are electrostatic discharge sensitive. Use a ground strap when handling Altanium components.

5. Slide a screwdriver between the silver post and the ledge on the cabinet and gently pry the board out. Refer to number 3 in [Figure 16-10](#).
-

CAUTION!

Static electricity hazard – risk of damage to the equipment. A static charge could damage a PCB. Do not place any PCB on carpets, rugs, or other material that is likely to create a static charge.

6. Carefully put the card on an earthed/grounded surface.

7. Remove and replace the faulty fuse with one of identical type and rating. Refer to [Figure 16-11](#).

Husky recommends SIBA 712540 Series or equivalent fuses. Make sure the fuse is fully seated. Poor seating will cause a hot spot, which can cause problems for the system.

NOTE: 20- and 30-Amp cards will only have two fuses. 5-Amp cards will have 8 fuses.

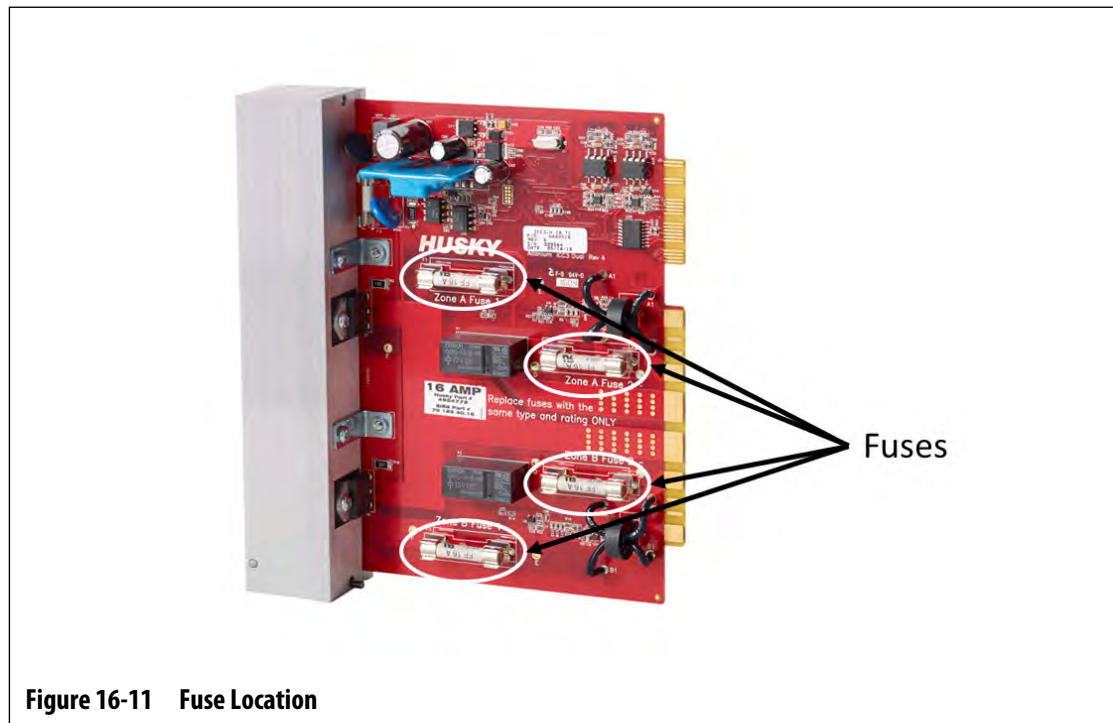
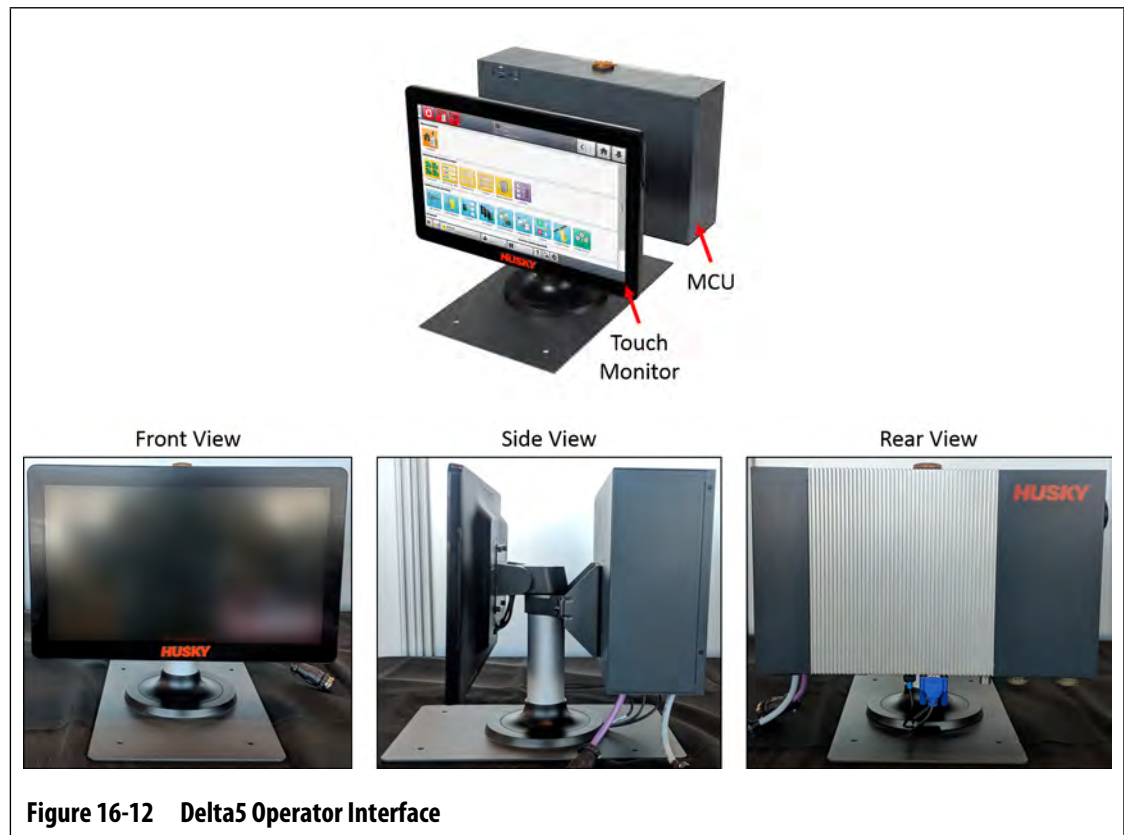


Figure 16-11 Fuse Location

8. Slide the new card into the slot and push the card slowly and firmly back into place. An incorrectly oriented card will not seat properly.
9. Tighten the upper and lower slotted fasteners on the heat sink.
10. Remove the lock out equipment and tag from the main power switch.
11. Energize the system at the main power switch.

16.4 Delta5 Operator Interface

The Delta5 operator interface is used to enter and display molding parameters. It consists of two main components: the touch monitor and the master control unit (MCU). Refer to [Figure 16-12](#).



The operator interface is also available in the configurations shown in [Table 16-1](#).

Table 16-1 Configuration Alternatives

Configuration	Description
Standalone	This is the standard configuration with the operator interface assembly mounting to the top of the controller mainframe.
Alternative Mount	This configuration is used for tall mainframes where the touch monitor is out of reach for the average user. It moves the touch monitor to the front of the controller, so it is easier to access. The MCU remains on mounted to the top of the controller mainframe.
Remote Mount	This configuration includes 7.6 m (25 ft) cables that allow the operator interface assembly to be mounted at a location away from the controller mainframe. This is a paid option.
Dual Monitor	This configuration includes a second touch monitor that can be mounted at a location away from the standalone operator interface to allow the controller to be accessed from two separate locations. This is a paid option.

The operator interface does not contain user-serviceable parts. You can only replace the touch monitor or master control unit as complete subassemblies.

In some conditions, the Altanium will not operate if the display is defective. If the display input power is correctly connected and all three phase indicators are lit, then the display could be at fault.

16.4.1 Remove and Replace the Touch Monitor



WARNING!

Electrical and mechanical hazard- risk of death, serious injury and/or damage to the equipment. Turn off all power to the system and disconnect it completely from the main input power.

CAUTION!

Static electricity hazard - risk of damage to the equipment. Turn off all power to the system and disconnect it completely from the main input power.

To remove and replace the touch monitor, do the steps that follow:

1. De-energize the system at the Altanium main power switch. Refer to [Figure 16-2](#).
2. Lock out and tag the main power switch in accordance with local codes.
3. On the back of the touch monitor, towards the left-hand side, find the cover for the Touchscreen and Power connectors, and then remove the screw that secures it with a #4 Phillips screwdriver. Refer to number 1 in [Figure 16-13](#).



WARNING!

Pinch Point Hazard – keep hands and fingers clear of the Delta5 touch monitor hinge mechanism.

4. After the cover has been removed, find the cable retaining bar and remove the screw that secures it with the #4 screwdriver. Refer to number 2 in [Figure 16-13](#).

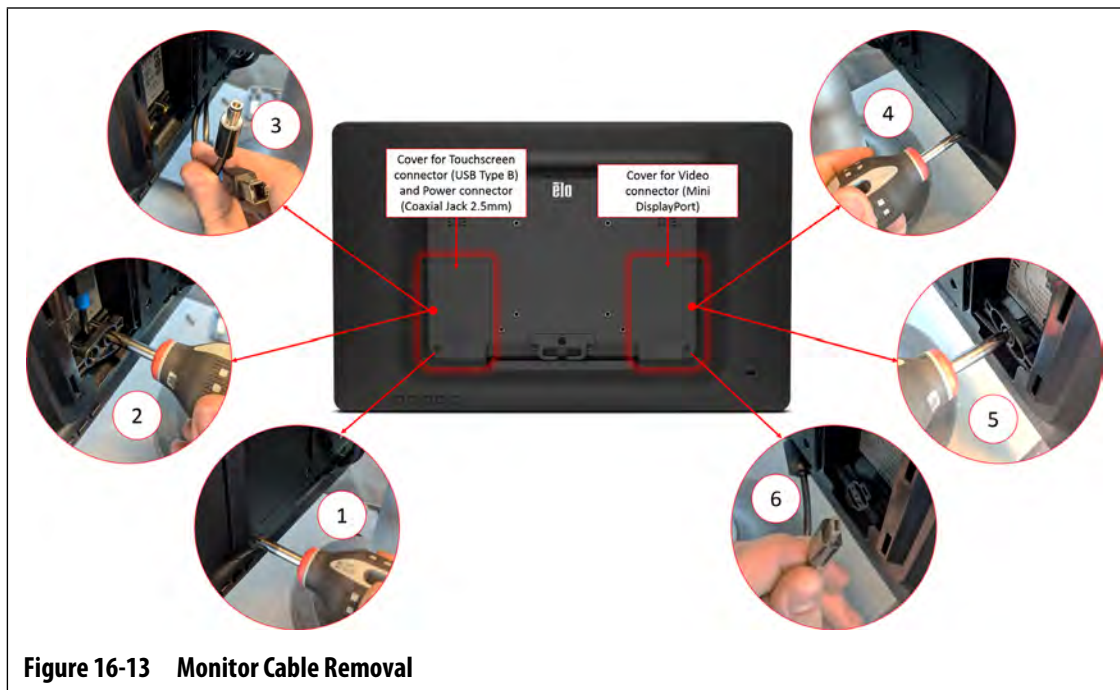


Figure 16-13 Monitor Cable Removal

5. After the cable retaining bracket has been removed, carefully pull downward on the Touchscreen (USB Type B) connector to disconnect it from its port and follow the same step for the adjacent Power (Coaxial Jack 2.5mm) connector. Refer to callout 3 in [Figure 16-13](#).
6. On the back of the touch monitor, towards the right-hand side, find the cover for the Video connector and remove the screw that secures it with a #4 Phillips screwdriver. Refer to callout 4 in [Figure 16-13](#).
7. After the cover has been removed, find the cable retaining bar and remove the screw that secures it with the #4 screwdriver. Refer to callout 5 in [Figure 16-13](#).
8. After the cable retaining bracket has been removed, carefully pull downward on the Video (Mini DisplayPort) connector to disconnect it from its port. Refer to callout 6 in [Figure 16-13](#).

CAUTION!

Be careful not to damage the cables.

9. On the back of the touch monitor, towards the lower center area, find the “C” shaped cable retaining clip and cut the cable ties to either side of it. Refer to callout 7 in [Figure 16-14](#).
10. Remove the cables from the retaining clip. Refer to callout 8 in [Figure 16-14](#).

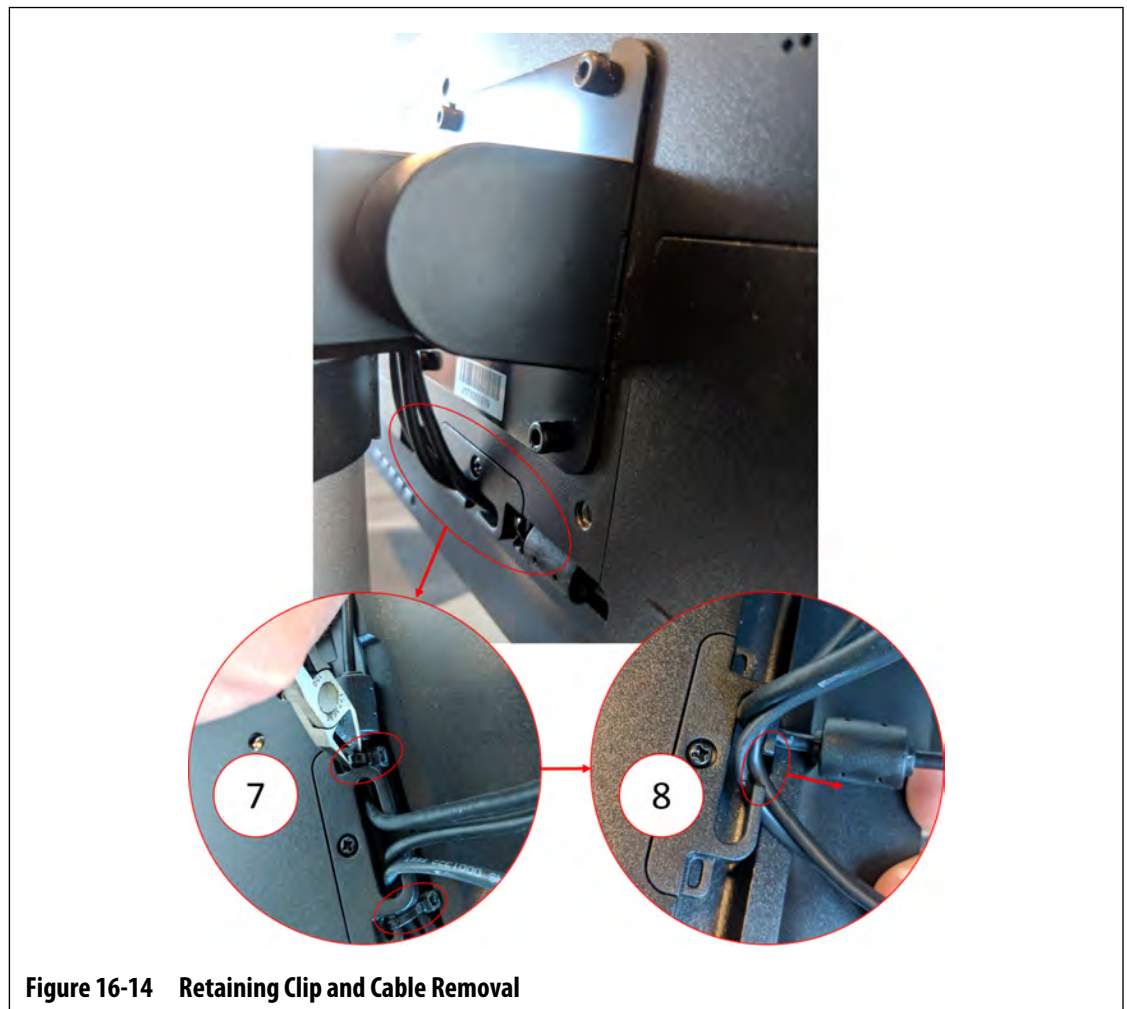


Figure 16-14 Retaining Clip and Cable Removal

11. Use a 4 mm right-angle Allen key or hex wrench to remove the two bottom socket cap screws from the retaining plate that secures the touch monitor to the pedestal. Refer to callout 9 in [Figure 16-15](#).



IMPORTANT!

Only loosen the top fasteners. The top mounting holes in the bracket holding the touch monitor are slotted and allow the monitor to be removed without removing the top fasteners completely.

12. Use the 4 mm right-angle Allen key or hex wrench to loosen the two top socket cap screws from the retaining plate that secures the touch monitor to the pedestal. Refer to callout 10 in [Figure 16-15](#).

Do not remove the screws.

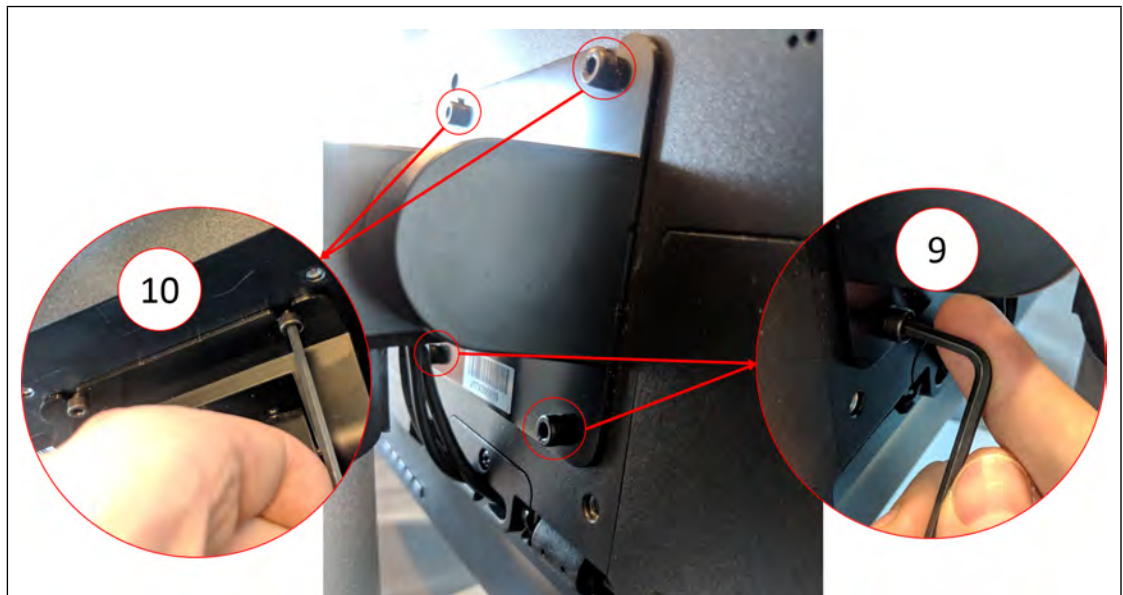
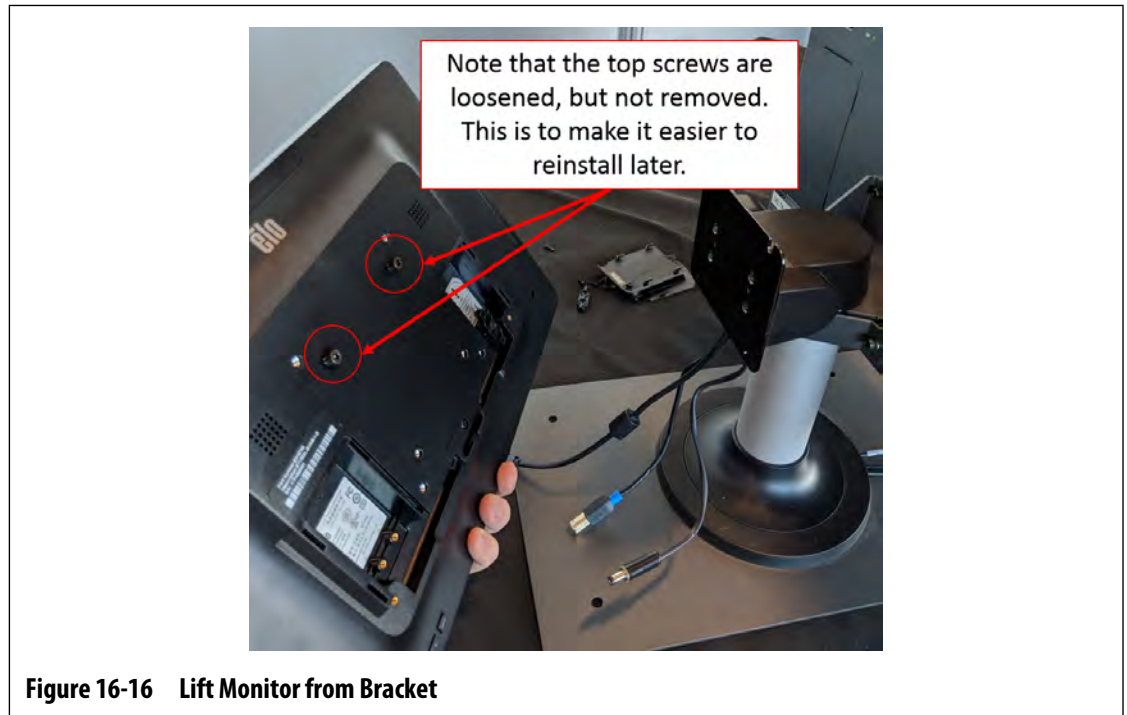


Figure 16-15 Removal of the Monitor Screws

- Securely hold the touch monitor and slide it upwards until the screws have cleared the upper mounting slots and pull forward to remove the touch monitor from the mounting bracket. Refer to [Figure 16-16](#).



- When you install the replacement monitor, make sure that the screws are pre-installed on the upper threaded studs and the screws are left off the lower studs on the back of the touch monitor.
- Securely hold the monitor and slide it down onto the mounting bracket, so the top monitor screws go into the bracket slots.
- Install the two bottom socket cap screws.
- Use a 4 mm right-angle Allen key or hex wrench to tighten all four screws.
- Put the cables behind the "C" shaped retaining clip.
- Install cable ties to secure the cables top the "C" shaped retaining clip.
- Connect the Video (Mini DisplayPort) connector to its port.
- Use the #4 screwdriver to install the cable retaining bar with the screw.
- Use the #4 Phillips screwdriver to install the right-hand side connector cover with the screw.
- Connect the Touchscreen (USB Type B) connector and Power (Coaxial Jack 2.5mm) connector to their related ports.
- Use the #4 screwdriver to install the cable retaining bar with the screw.
- Use the #4 Phillips screwdriver to install the left-hand connector cover with the screw.
- Remove the lock out equipment and tag from the main power switch.
- Energize the system at the main power switch.

16.4.2 Remove and Replace the MCU



WARNING!

Electrical and mechanical hazard- risk of death, serious injury and/or damage to the equipment. Turn off all power to the system and disconnect it completely from the main input power.

To remove and replace the MCU, do the steps that follow:

1. De-energize the system at the Altanium main power switch. Refer to [Figure 16-2](#).
2. Lock out and tag the main power switch in accordance with local codes.
3. Find and disconnect the Touch Screen Signal, Touch Monitor Power, and VGA or LCD1 (HDMI) connectors at the bottom of the MCU enclosure. Refer to [Figure 16-17](#).



IMPORTANT!

Because of the options purchased and the configuration of your controller there may be more connectors to disconnect. Refer to the cable connections in [Table 14-10](#) for a full list of possible connectors.

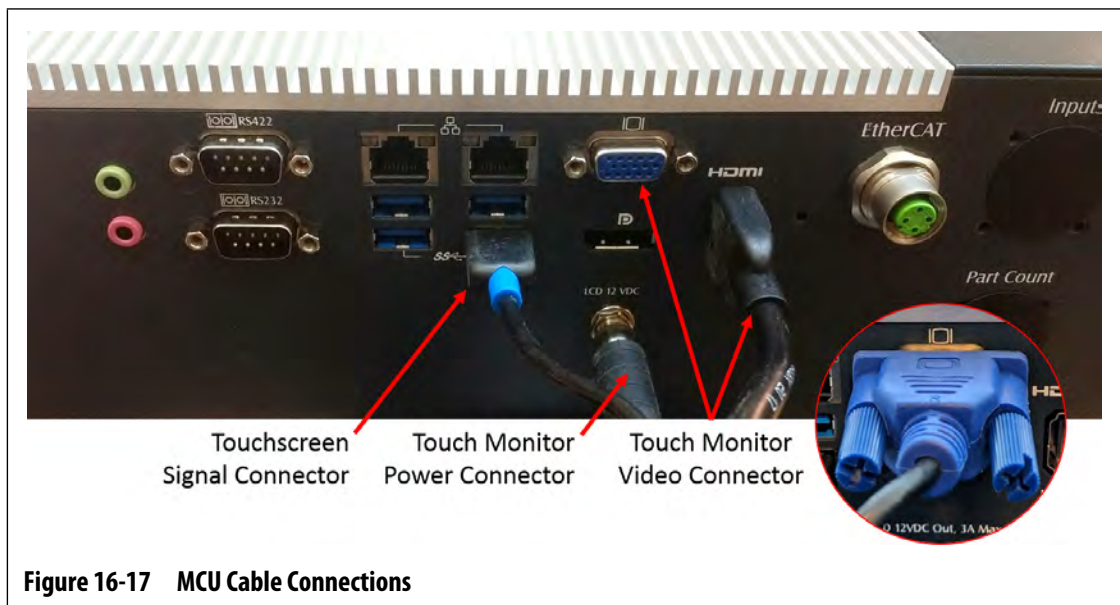


Figure 16-17 MCU Cable Connections

4. Disconnect all other cables from the bottom of the MCU enclosure if your system has other options.
5. Rotate the touch monitor to the full back position. Refer to [Figure 16-18](#).

6. Find the two lower screws that hold the MCU to the mounting bracket and completely remove them with a 4 mm right-angle Allen key or hex wrench. Refer to [Figure 16-18](#).

**IMPORTANT!**

Only loosen the top fasteners. The top mounting holes in the bracket holding the touch monitor are slotted and allow the monitor to be removed without removing the top fasteners completely.

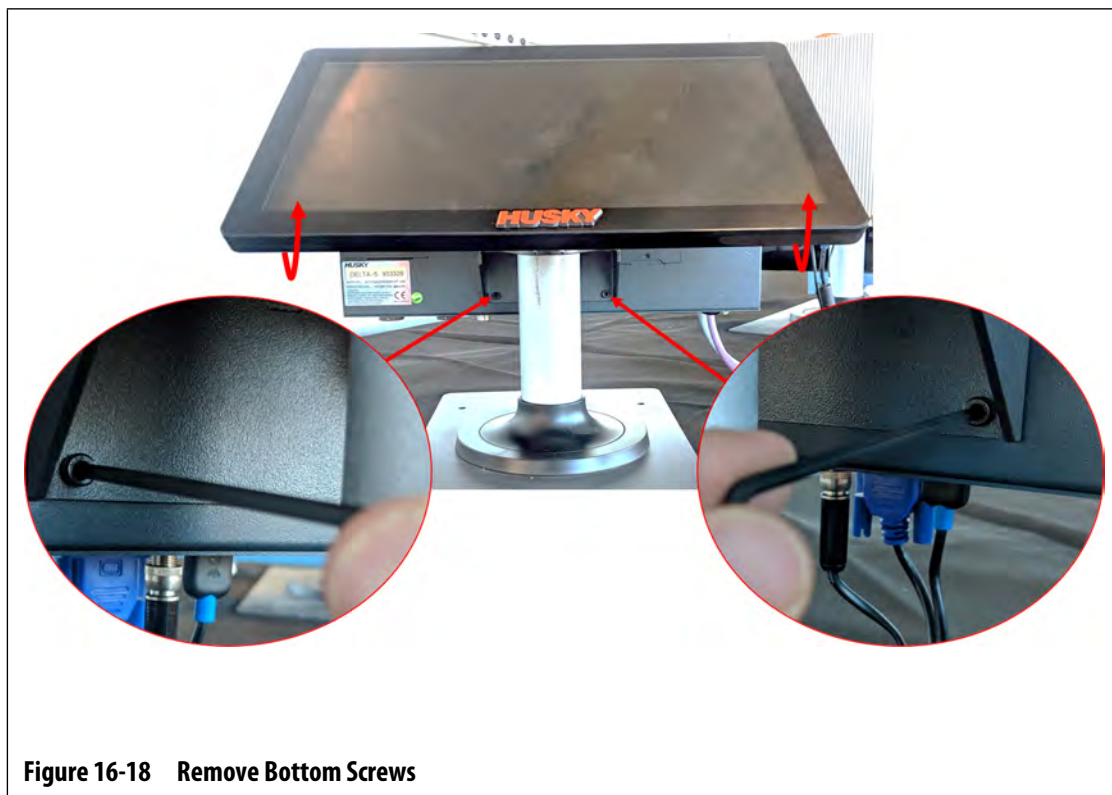


Figure 16-18 Remove Bottom Screws

7. Rotate the touch monitor to the full forward position.

- Find the two top fasteners that hold the MCU to the mounting bracket and loosen them with a 4 mm right-angle Allen key or hex wrench. Refer to [Figure 16-19](#).
Loosen the screws only; do not remove them.

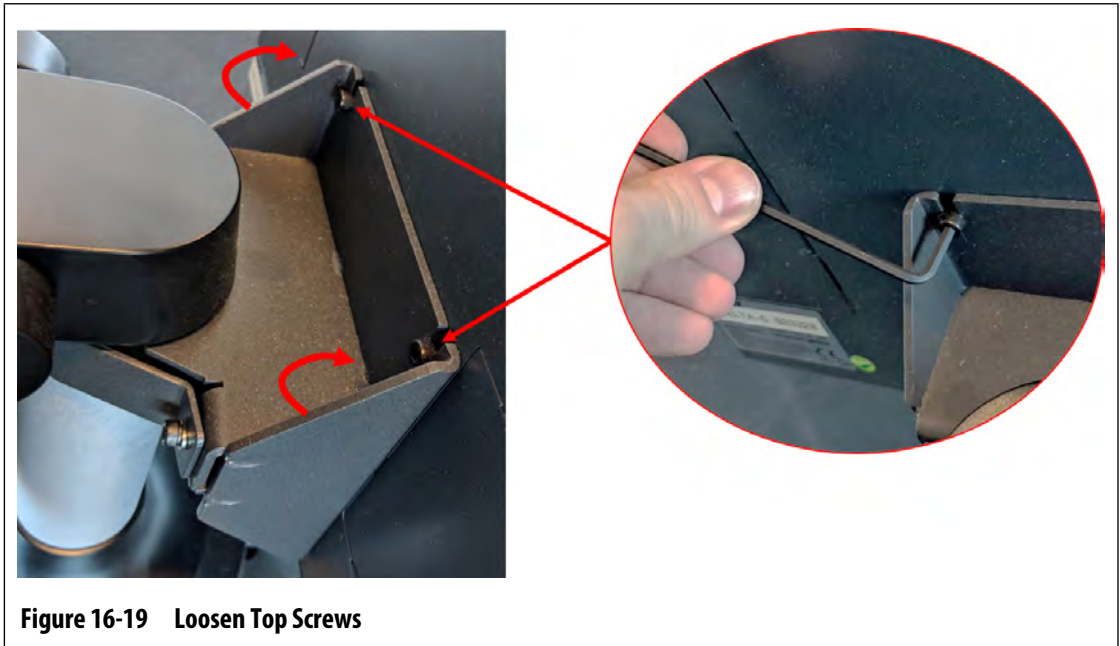


Figure 16-19 Loosen Top Screws

- Securely hold the MCU and slide it up until the screws have cleared the upper mounting slots and pull forward to remove the MCU from the mounting bracket. Refer to [Figure 16-20](#).

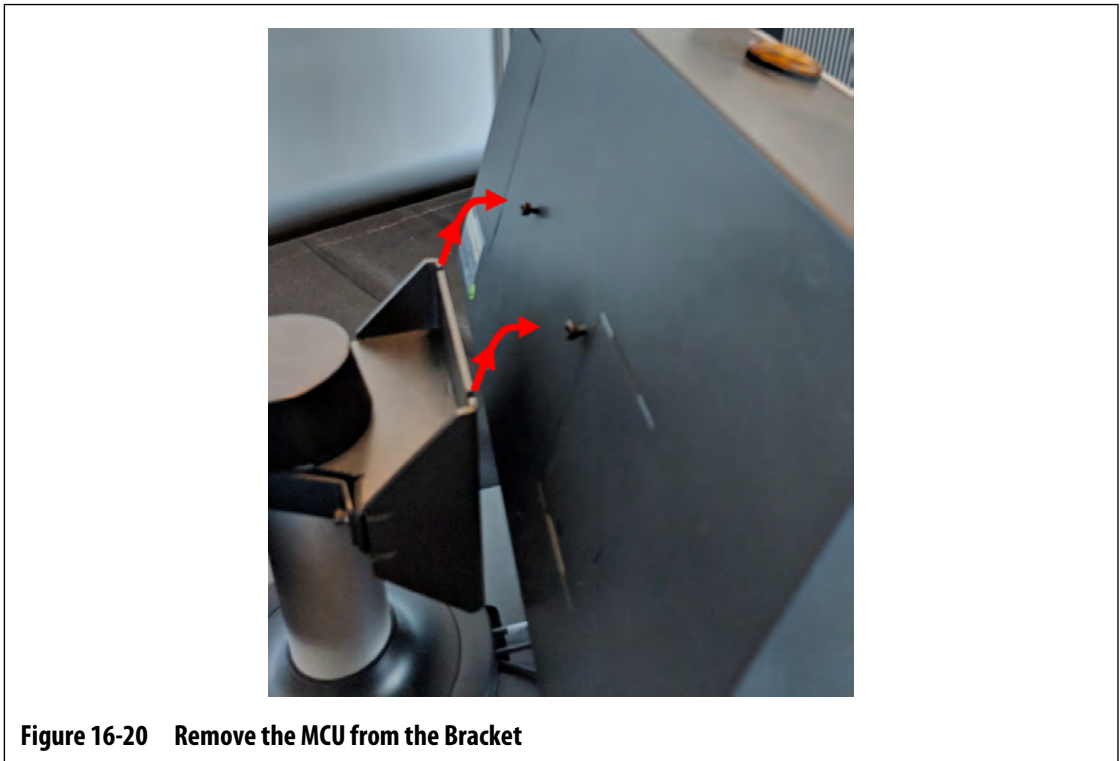


Figure 16-20 Remove the MCU from the Bracket

- When you install the replacement MCU, make sure that the screws are pre-installed on the upper threaded studs and the screws are left off the lower studs on the back of the touch monitor.

- 11.** Securely hold the MCU and slide it down onto the mounting bracket, so the top MCU screws go into the bracket slots.
- 12.** Rotate the touch monitor to the full back position. Refer to [Figure 16-18](#).
- 13.** Install the two bottom socket cap screws and tighten them with the 4 mm right-angle Allen key or hex wrench.
- 14.** Rotate the touch monitor to the full forward position.
- 15.** Tighten the two top socket cap screws with the 4 mm right-angle Allen key or hex wrench.
- 16.** Connect the Touch Screen Signal, Touch Monitor Power, and VGA or LCD1 (HDMI) connectors at the bottom of the MCU enclosure.
- 17.** Connect all other cables to the bottom of the MCU enclosure if your system has other options.
- 18.** Remove the lock out equipment and tag from the main power switch.
- 19.** Energize the system at the main power switch.

16.4.3 Remove and Replace the Operator Interface



WARNING!

Electrical and mechanical hazard- risk of death, serious injury and/or damage to the equipment. Turn off all power to the system and disconnect it completely from the main input power.

To remove and replace the operator interface, do the steps that follow:

1. De-energize the system at the Altanium main power switch. Refer to [Figure 16-2](#).
2. Lock out and tag the main power switch in accordance with local codes.
3. At the bottom of the MCU enclosure, find and disconnect the Power and Communication connectors that come from the controller mainframe. Refer to [Figure 16-21](#).

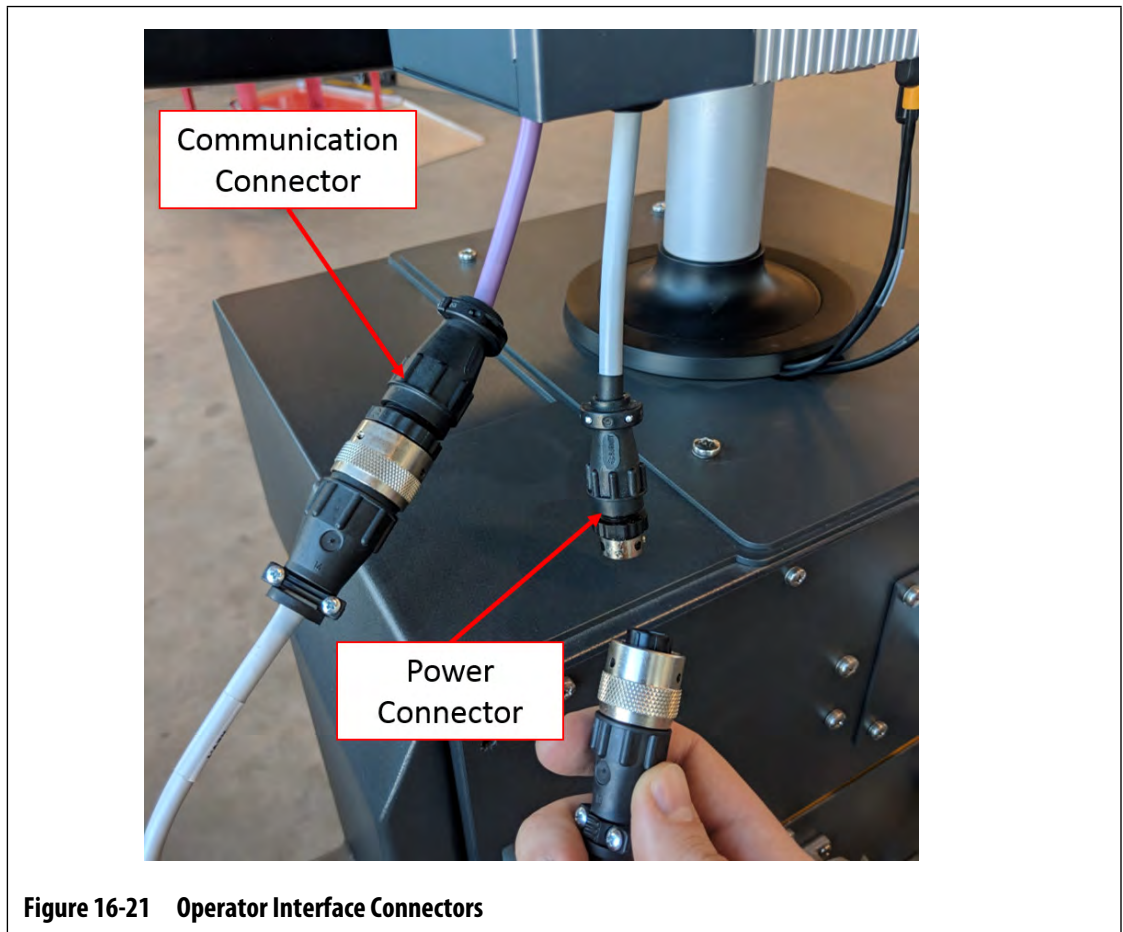


Figure 16-21 Operator Interface Connectors

4. Use a #4 Phillips screwdriver to remove the four screws that hold the operator interface to the top of the mainframe. Refer to [Figure 16-22](#).

NOTE: This step will require a screwdriver short enough to clear the MCU located above the two back mounting screws.

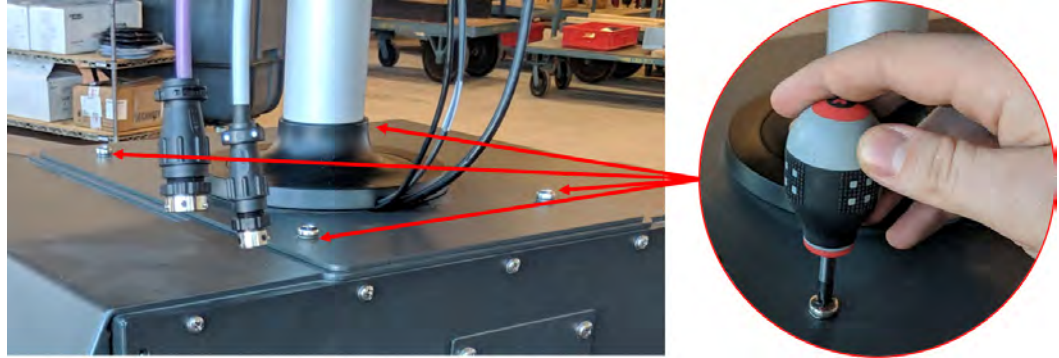


Figure 16-22 Operator Interface Screw Removal

5. Securely hold the operator interface at the silver mounting pole and carefully lift the unit from the top of the mainframe. Refer to [Figure 16-23](#).

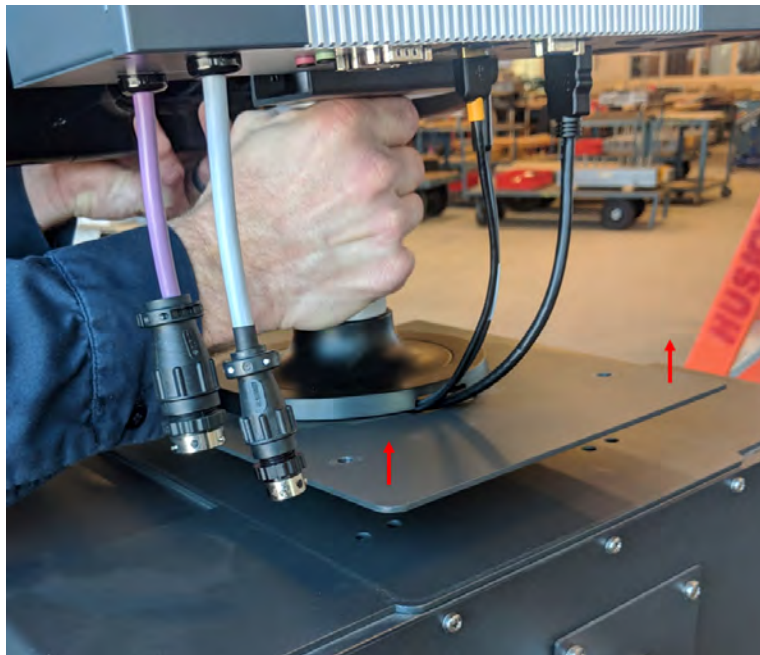


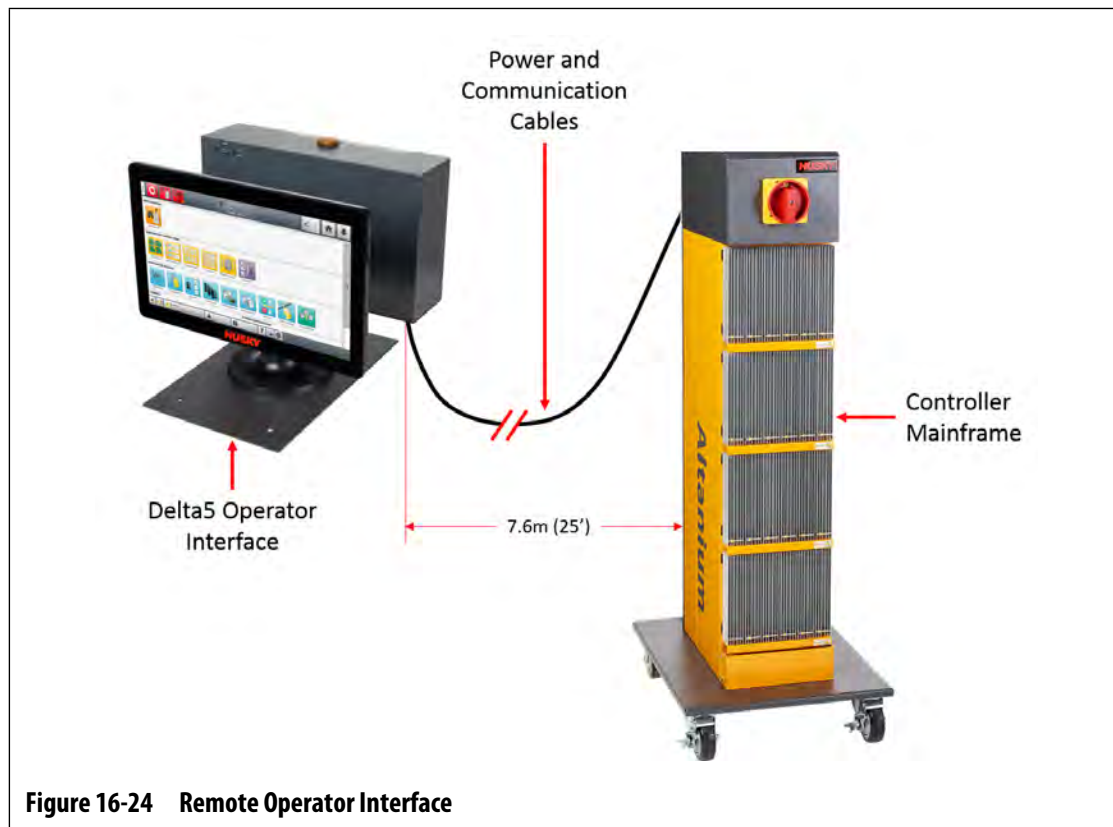
Figure 16-23 Remove the Operator Interface

6. When you install the replacement operator interface, securely hold the operator interface at the silver mounting pole when you lift it.
7. Put the operator interface on the top of the mainframe.
8. Align the four screw holes in the base plate with the holes in the top of the mainframe.
9. Install the four screws and tighten them with a #4 Phillips screwdriver.

NOTE: This step will require a screwdriver short enough to clear the MCU located above the two back mounting screws.

- 10.** Connect the Power and Communication connectors that come from the controller mainframe to the bottom of the MCU enclosure.
- 11.** Remove the lock out equipment and tag from the main power switch.
- 12.** Energize the system at the main power switch.

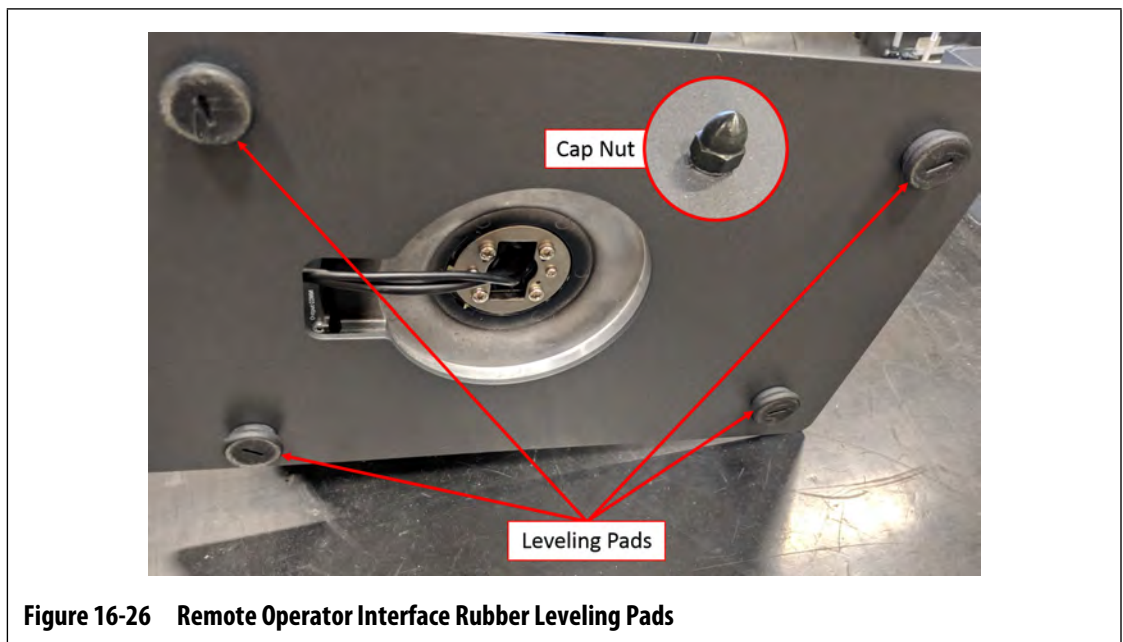
16.4.4 Install the Remote Operator Interface



Installation of the remote operator interface can be:

- Permanently mounted in place with the use of the four mounting holes in the base plate. Refer to [Figure 16-25](#).
- Set on a flat surface with the use of the supplied rubber leveling pads. Refer to [Figure 16-26](#).

If the rubber leveling pads are used, install them on the bottom of the base plate with the supplied cap nuts.



WARNING!

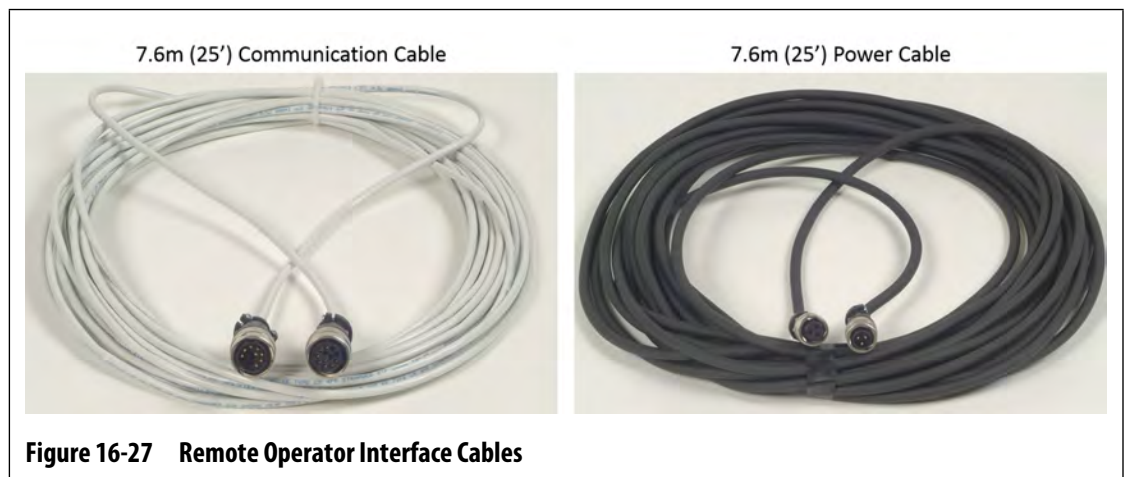
Electrical and mechanical hazard- risk of death, serious injury and/or damage to the equipment. Turn off all power to the system and disconnect it completely from the main input power.

To install the remote operator interface, do the steps that follow:

**WARNING!**

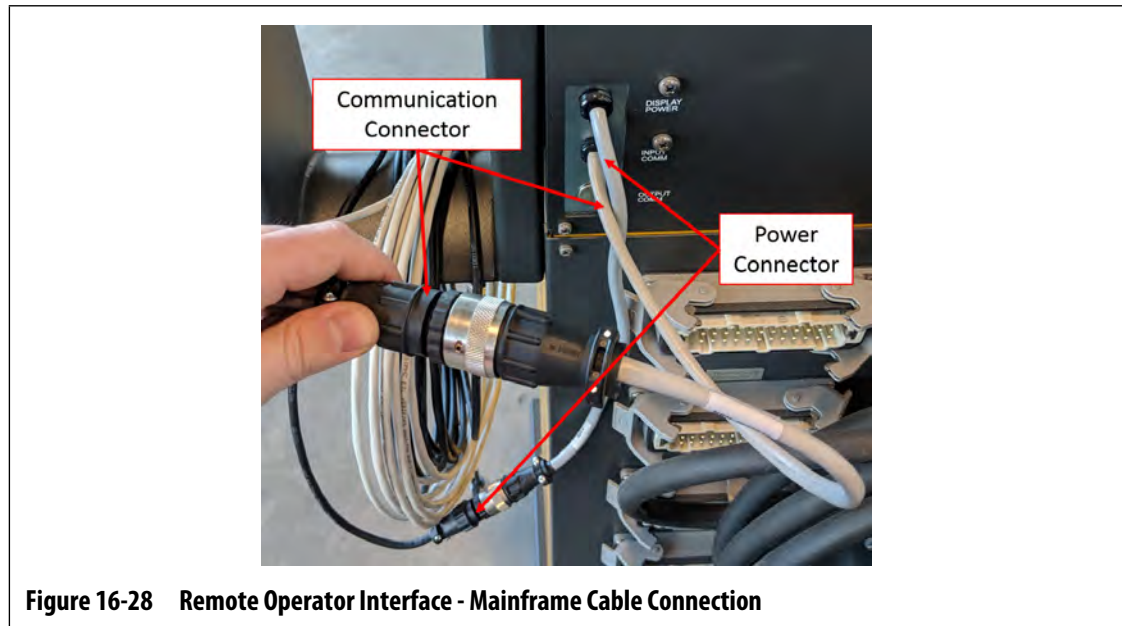
Make sure that the operator interface is in an area free of vibration to prevent premature failure of the electronic components in the MCU and touch monitor. Make sure that the operator interface is in an area free of debris and liquids. If the leveling pads are used, make sure that the operator interface is put on a flat level surface to prevent the unit from movement or falling when in use.

1. If necessary, de-energize the system at the Altanium main power switch. Refer to [Figure 16-2](#).
2. If necessary, lock out and tag the main power switch in accordance with local codes.
3. Make sure that the remote operator interface is installed on a level surface that can support the unit safely.
4. Find the 7.6 m (25 ft) Communication and Power cables. Refer to [Figure 16-27](#).



5. Connect the female end of the 7.6 m (25 ft) communication cable to the male communication connector on the back of the controller mainframe. Refer to [Figure 16-28](#).

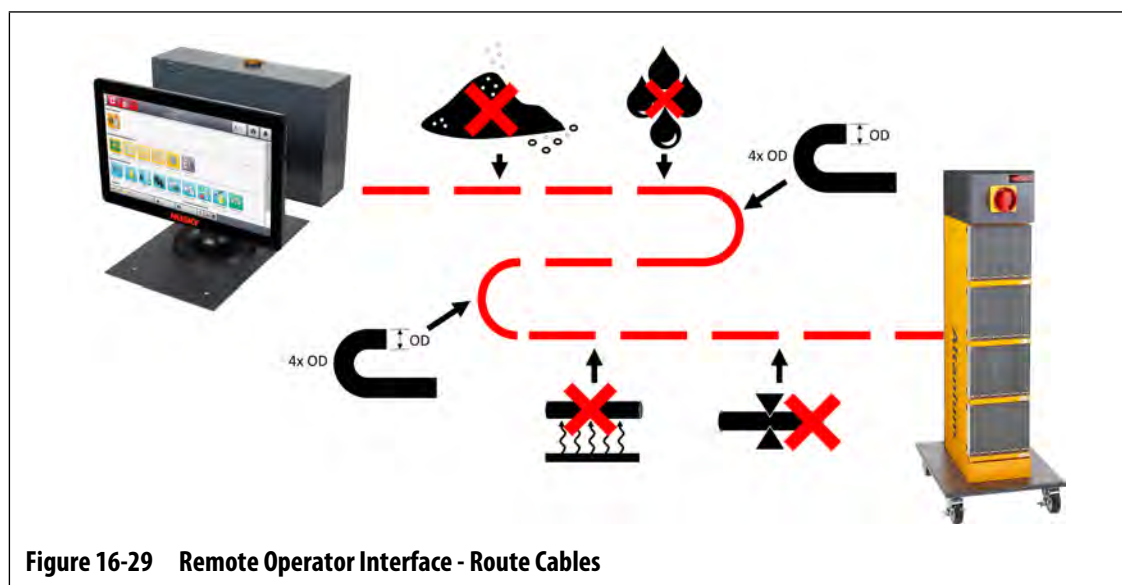
- Connect the male end of the 7.6 m (25 ft) power cable to the female power connector on the back of the controller mainframe. Refer to [Figure 16-28](#).



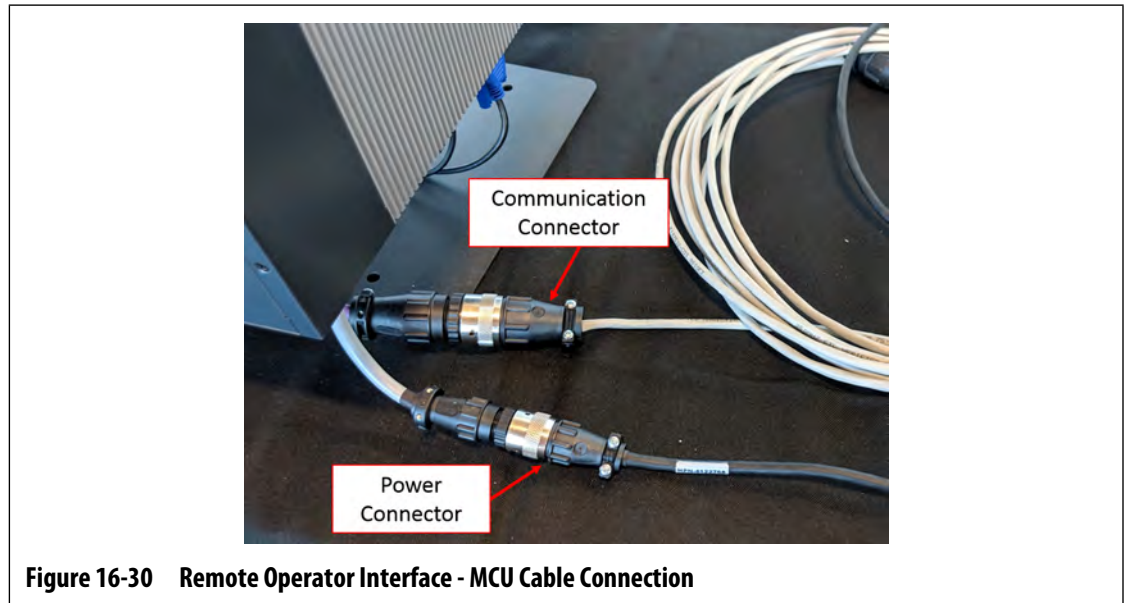
WARNING!

The cables should be routed in accordance with local codes. This includes areas free of debris and liquids and away from sharp edges or objects that can pinch or cut the cable housing or conductors. The cables should not be bent at a radius less than 4x the outer diameter of the cables. Ensure that the cables are routed in areas where the ambient temperature is within a range of -10 °C to 60 °C (14 °F to 140 °F). It is also recommended that the cables are routed away from other cables, especially those that are high voltage or high frequency, to minimize signal interference.

- Route the 7.6 m (25 ft) Communication and Power cables from the controller mainframe to the location of the operator interface. Refer to [Figure 16-29](#).



8. Connect the male end of the 7.6 m (25 ft) communication cable to the female communication connector on the bottom of the operator interface MCU. Refer to [Figure 16-30](#).
9. Connect the female end of the 7.6 m (25 ft) power cable to the male power connector on the bottom of the operator interface MCU. Refer to [Figure 16-30](#).



10. If necessary, remove the lock out equipment and tag from the main power switch.
11. Energize the system at the main power switch.

16.4.5 Install the Alternative Mounted Operator Interface

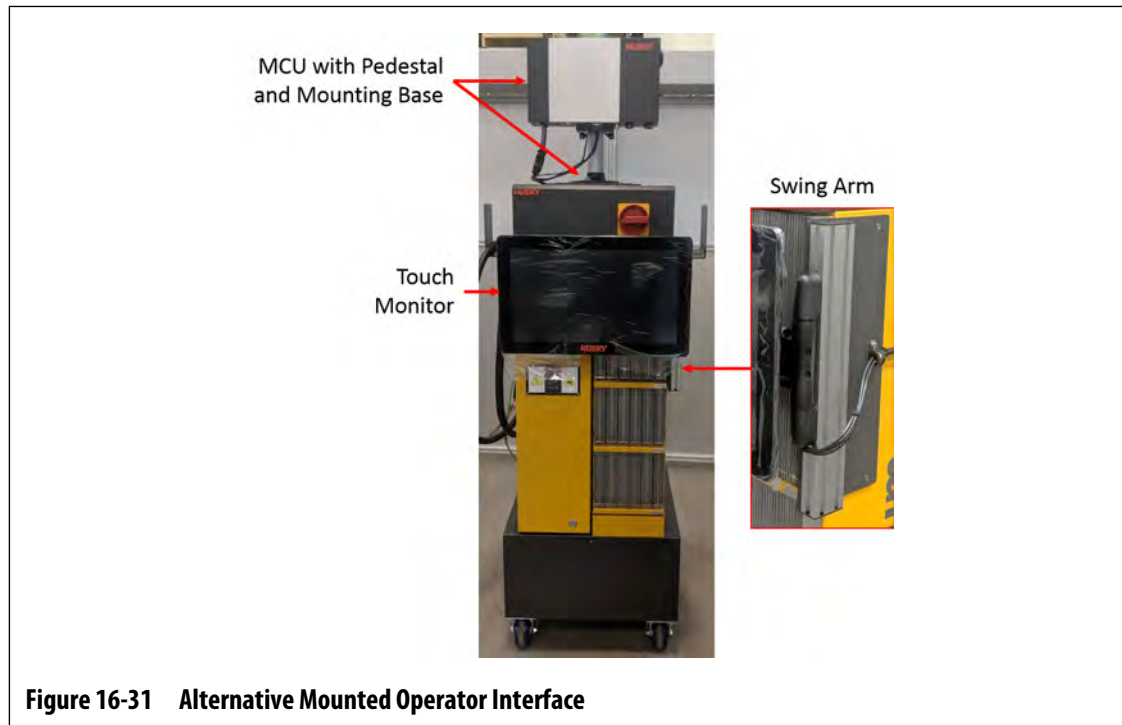


Figure 16-31 Alternative Mounted Operator Interface



WARNING!

Electrical and mechanical hazard- risk of death, serious injury and/or damage to the equipment. Turn off all power to the system and disconnect it completely from the main input power.

To install the alternative mounted operator interface, do the steps that follow:

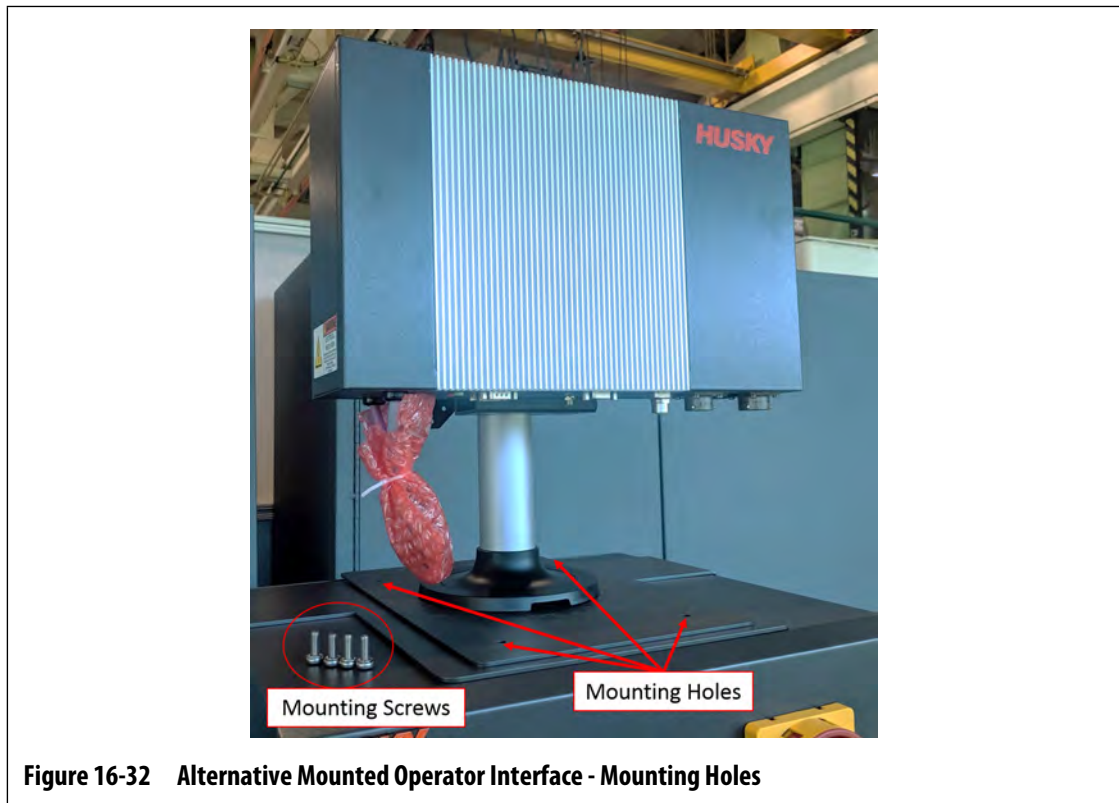
1. If necessary, de-energize the system at the Altanium main power switch. Refer to [Figure 16-2](#).
2. If necessary, lock out and tag the main power switch in accordance with local codes.



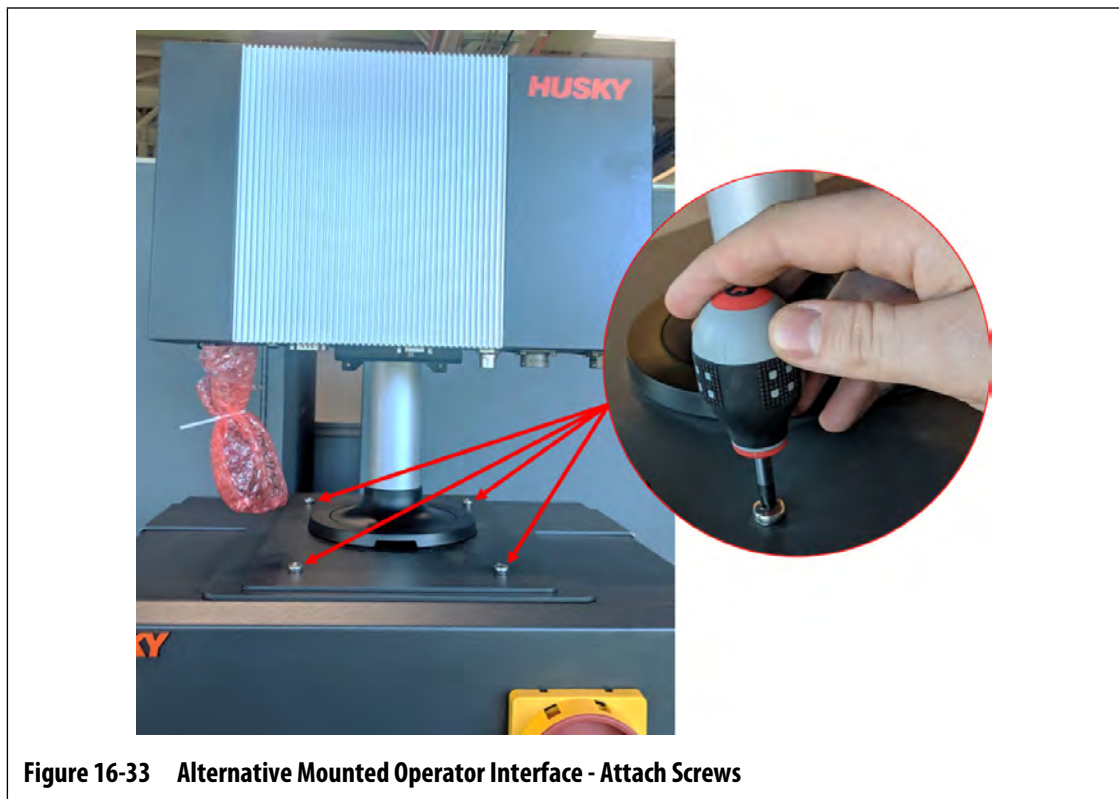
IMPORTANT!

The MCU with pedestal and mounting base should be orientated so that the heatsink on the MCU faces towards the front of the controller.

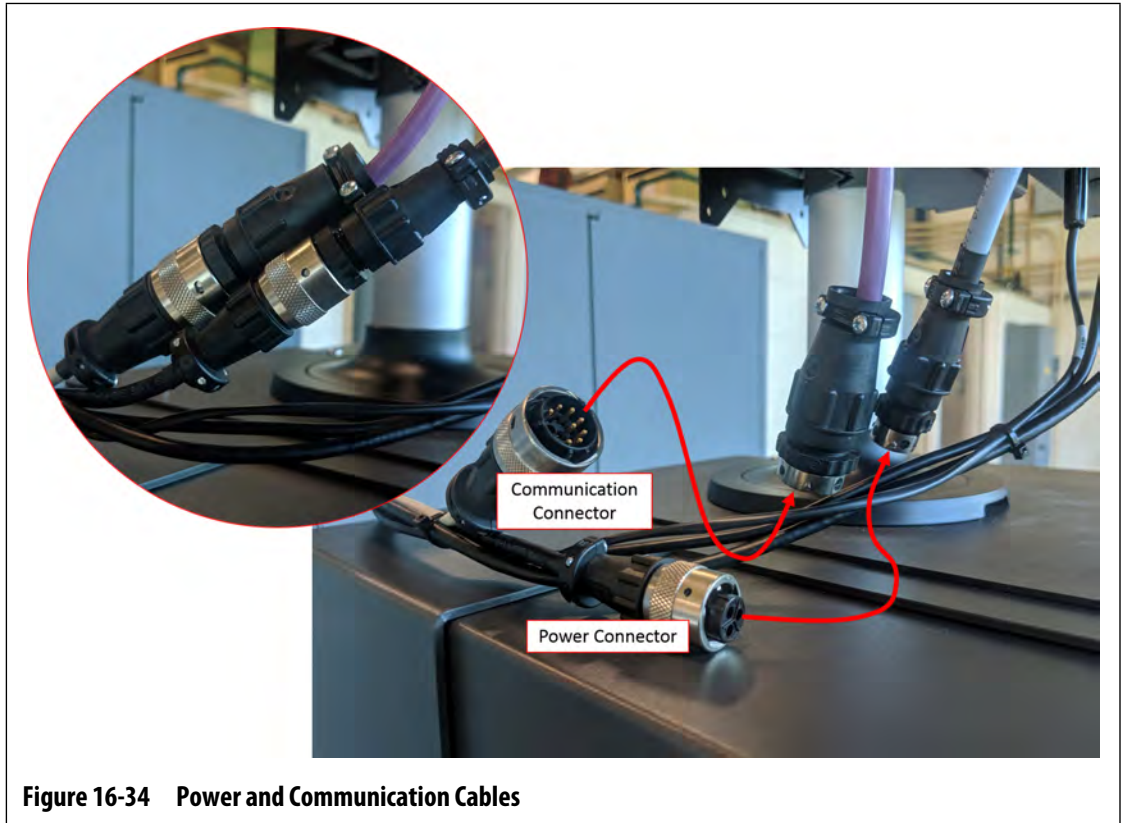
3. Unpack and place the MCU assembly with pedestal and mounting base on top of the controller mainframe.
4. Make sure that the mounting holes in the base align with those in the top of the mainframe. Refer to [Figure 16-32](#).



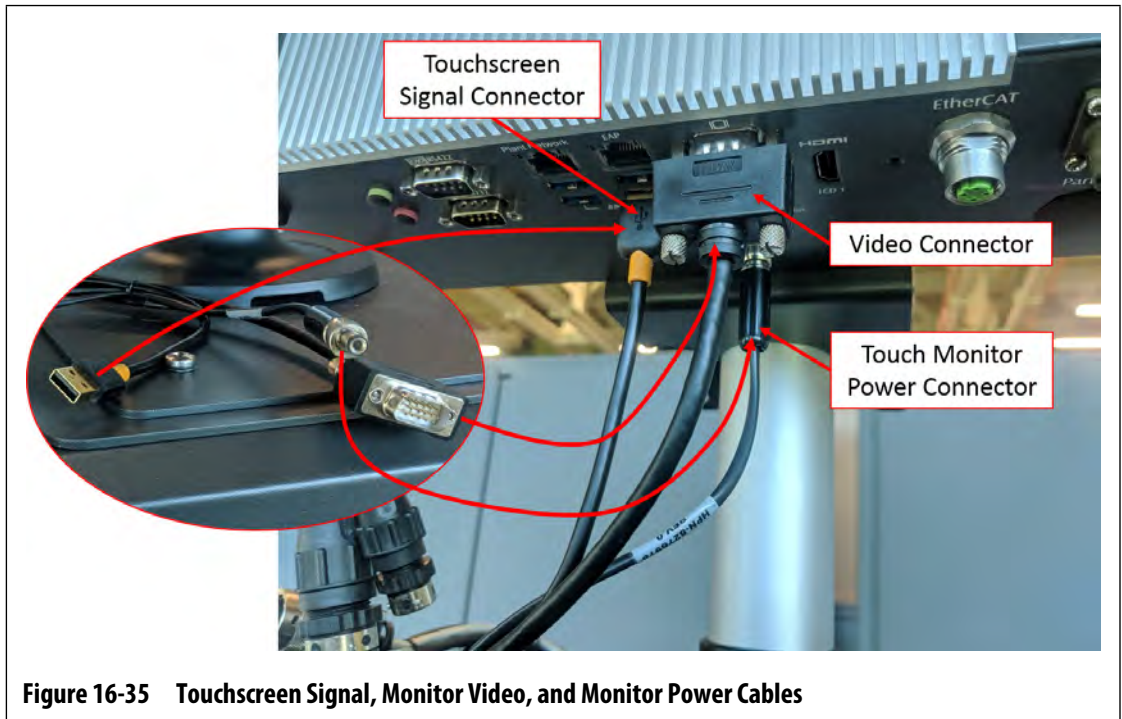
- 5. Use a #4 Phillips screwdriver to install the supplied four M6 metric screws through the mounting holes on the MCU base plate into the top of the mainframe.
- NOTE:** This step will require a screwdriver short enough to clear the MCU located above the two back mounting screws. Refer to [Figure 16-33](#).



6. Connect the female Power cable connector and male Communication cable connector to the male Power connector and female Communication connector on the MCU. Refer to [Figure 16-34](#).



7. Connect the Touchscreen Signal cable connector, Touch Monitor Video cable connector and Touch Monitor Power cable connector to the Touch Screen connector, LCD 12 VDC connector, and VGS connector on the bottom of the MCU. Refer to [Figure 16-35](#).



8. Use tie wraps to collect the lengths of cables between the touch monitor, controller mainframe, and MCU. Make sure that all wires are away from pinch points and that there is enough service loop to let the touch monitor and swing arm move freely. Refer to [Figure 16-36](#).



Figure 16-36 Attach Tie Wraps to Cables



IMPORTANT!

Because of the options purchased and the configuration of your controller there may be more connectors to connect. Refer to the cable connections in [Table 14-10](#) for a full list of possible connectors.

9. If necessary, remove the lock out equipment and tag from the main power switch.
10. Energize the system at the main power switch.

16.4.6 Install the Dual Touch Monitor

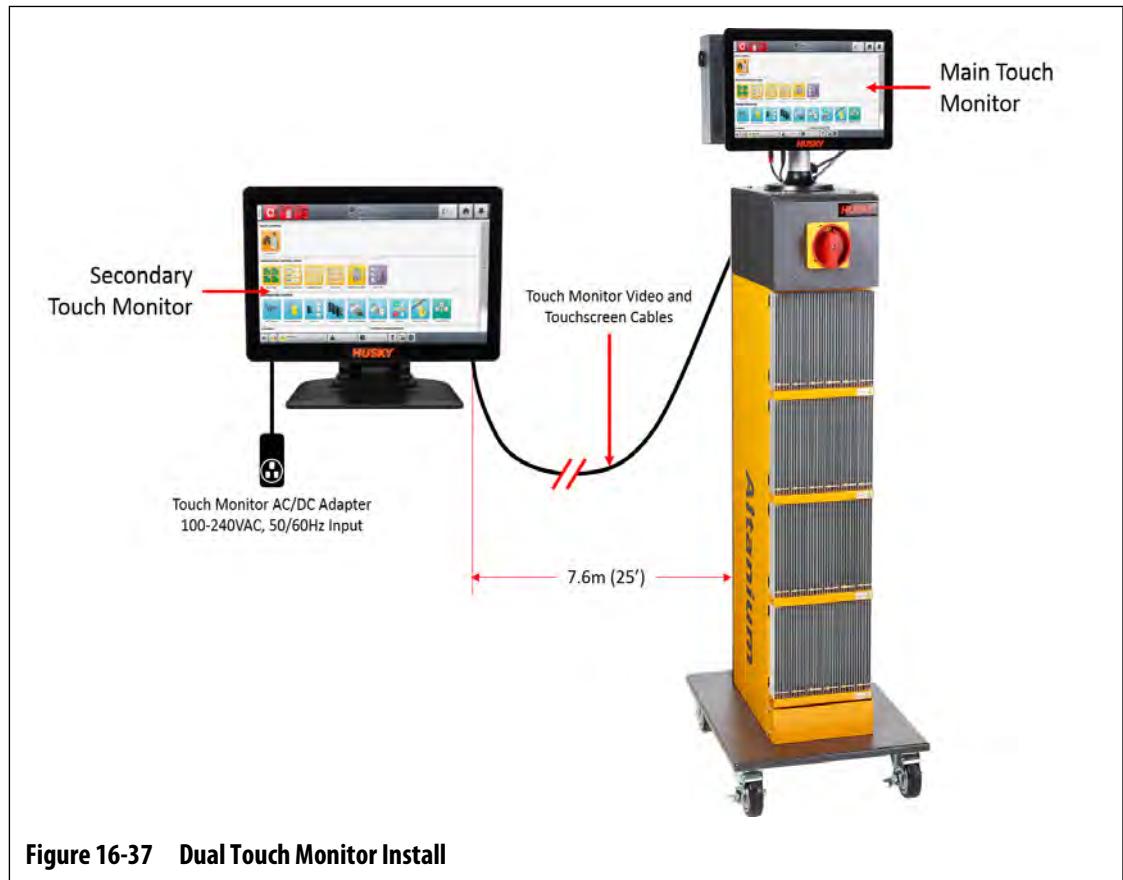


Figure 16-37 Dual Touch Monitor Install



WARNING!

Electrical and mechanical hazard- risk of death, serious injury and/or damage to the equipment. Turn off all power to the system and disconnect it completely from the main input power.

To install the dual touch monitor, do the steps that follow:

1. If necessary, de-energize the system at the Altanium main power switch. Refer to [Figure 16-2](#).
2. If necessary, lock out and tag the main power switch in accordance with local codes.
3. Find and unpack the items that follow (refer to [Figure 16-38](#)):
 - Secondary touch monitor with the AC/DC adapter and extension cables
 - USB extension cable with signal booster
 - HDMI to DVI extension cable
 - DisplayPort to HDMI converter



4. Connect the USB Extension cable (USB Type A connector end) to one of the available USB ports on the bottom of the MCU enclosure. Refer to [Figure 16-39](#).

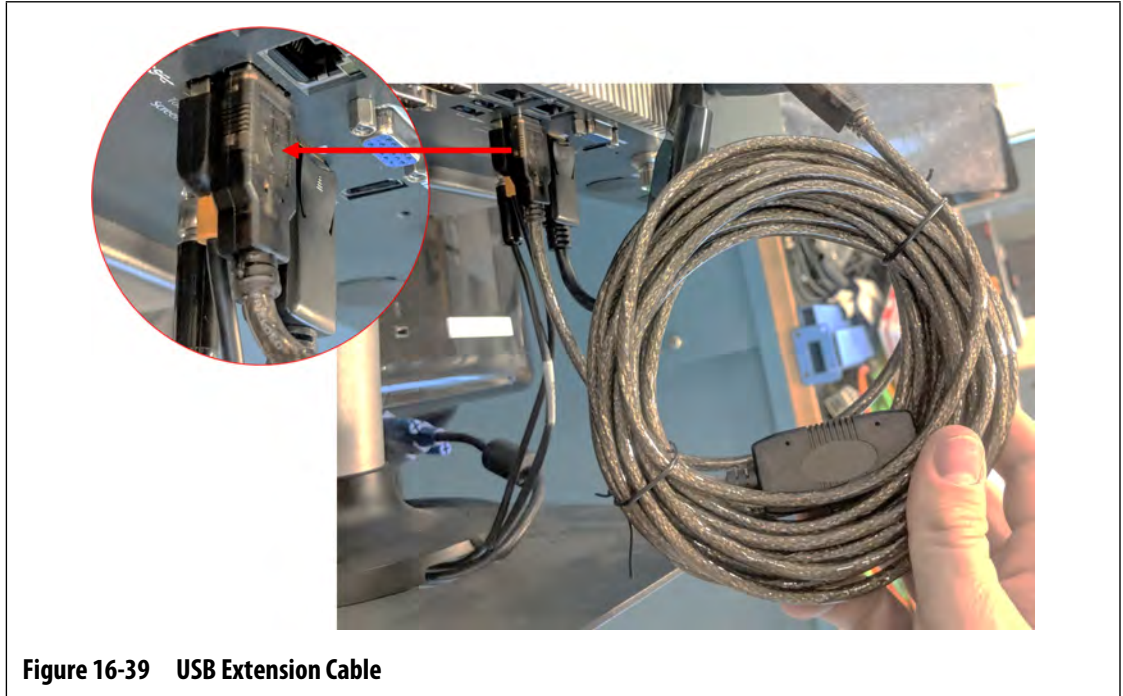


Figure 16-39 USB Extension Cable

5. Connect the DisplayPort to HDMI Converter (DisplayPort connector end) to the DisplayPort connector (behind the VGA connector) on the bottom of the MCU enclosure. Refer to [Figure 16-40](#).

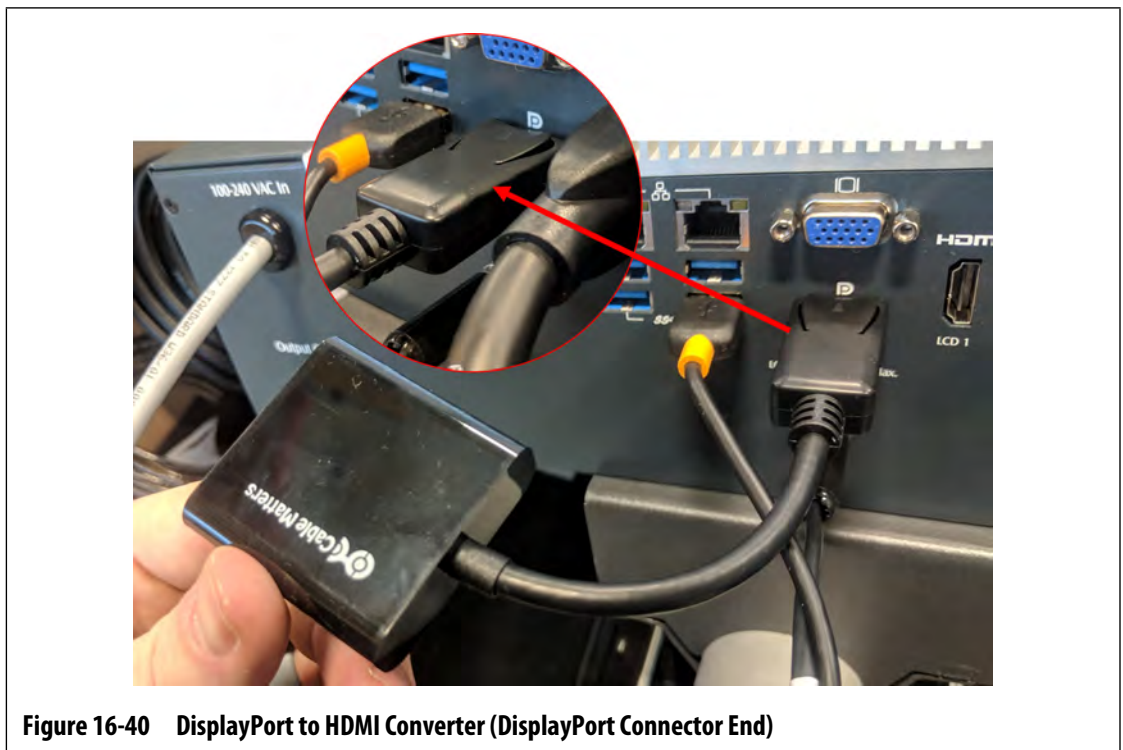


Figure 16-40 DisplayPort to HDMI Converter (DisplayPort Connector End)

6. Connect the HDMI end of the HDMI-to-DVI Extension cable to the HDMI connector end of the DisplayPort to HDMI Converter. Refer to [Figure 16-41](#).



Figure 16-41 HDMI-to-DVI Extension

7. Route the USB and HDMI-to-DVI Extension cables from the MCU to the location of the secondary touch monitor. Refer to [Figure 16-42](#).



WARNING!

The cables should be routed in accordance with local codes. This includes areas free of debris and liquids and away from sharp edges or objects that can pinch or cut the cable housing or conductors. The cables should not be bent at a radius less than 4x the outer diameter of the cables. Ensure that the cables are routed in areas where the ambient temperature is within a range of -10 °C to 60 °C (14 °F to 140 °F). It is also recommended that the cables are routed away from other cables, especially those that are high voltage or high frequency, to minimize signal interference.

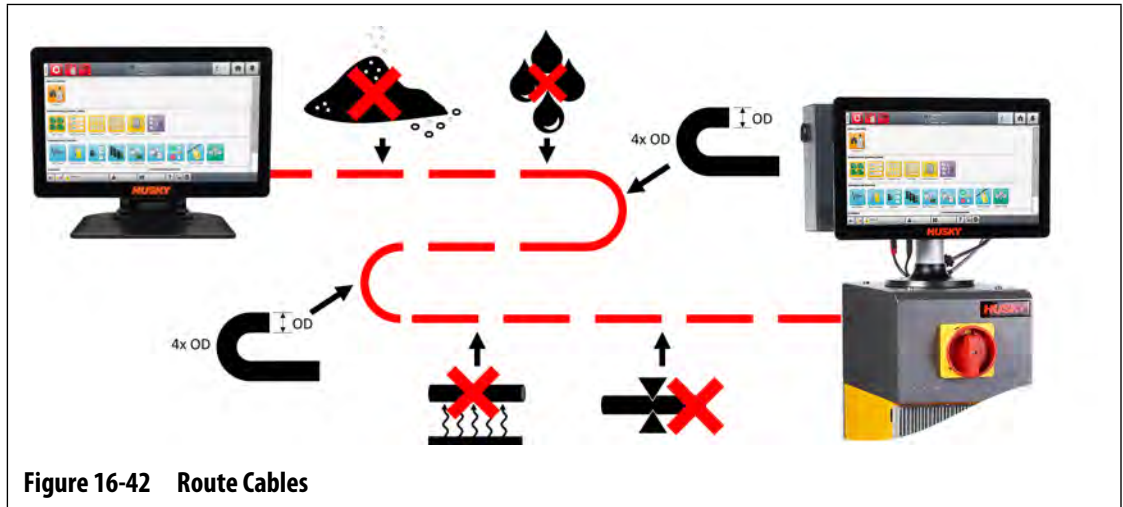


Figure 16-42 Route Cables

8. Configure the AC/DC Adapter for the extension cable plug type that is compatible with the electrical outlet where it will be connected. Refer to [Figure 16-43](#).



IMPORTANT!

The AC/DC Adapter provides power to the secondary touch monitor and is required to be plugged into its own power source. It is important that a power source is always available when you select the location of the secondary touch monitor.

CAUTION!

The AC/DC Adapter is rated for an input voltage of 100-240 VAC, 50/60 Hz. Connection to a voltage outside this range could result in catastrophic damage to the adapter and touch monitor.

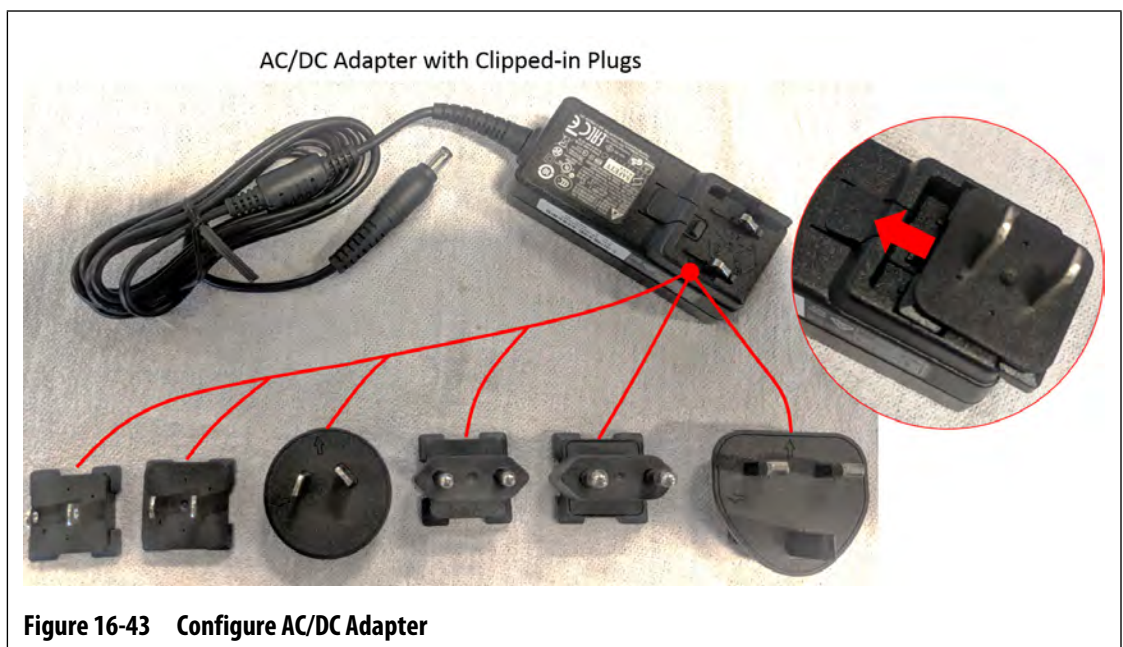
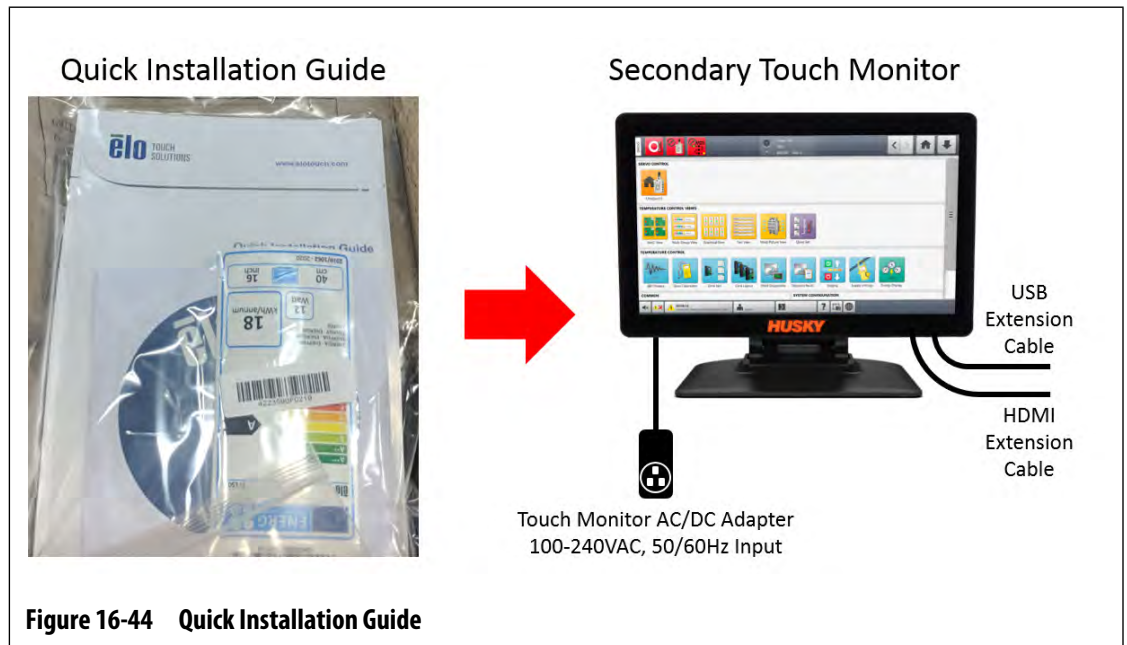


Figure 16-43 Configure AC/DC Adapter

CAUTION!

Make sure that the secondary touch monitor is in an area free of vibration to prevent premature failure of the electronic components in the unit. Make sure that the secondary touch monitor is in an area free of debris and liquids and that it is placed on a flat, level surface to prevent the unit from movement or falling when in use.

9. Refer to the Quick Installation Guide (in the box for the secondary touch monitor) for instructions about how to correctly install the stand and connect the AC/DC Adapter, USB Extension cable (USB Type B connector end), and HDMI-to-DVI Extension cable to the secondary touch monitor. Refer to [Figure 16-44](#).



10. If necessary, remove the lock out equipment and tag from the main power switch.
11. Energize the system at the main power switch.

16.5 Thermocouple Calibration

To run a satisfactory injection process, temperature accuracy of the zones is important. The Altanium Delta5 lets you make sure that your temperature readings are correct with the use of zone calibration.



NOTE: Amperage and voltage calibrations are only done by Husky service.

These instructions are for the Altanium Delta5 with hot runner temperature control. They are to be used with systems that are configured for J-Type thermocouple inputs. It is recommended that this procedure is performed to all zones in the system on an annual basis.

NOTE: The system has been factory-calibrated and, in most conditions, it is not necessary to recalibrate until the Altanium operated for one year. For questions or additional information about thermocouple calibration, contact the nearest Husky Regional Service and Sales office.

The required equipment necessary to complete this procedure are shown in [Table 16-2](#).

Table 16-2 Thermocouple Calibration Equipment

Equipment	Image	Comments
J-Type Thermocouple Simulator		Recommended Model: Omega CL23A
J-Type Thermocouple Wire Harness		Must include a mating connector or contacts that will plug into the thermocouple connector on the back of the controller.

To calibrate a thermocouple, do the steps the follow:

1. Make sure that all cards in the system are in place and properly secured.
2. Make sure that all card slots and access panels are covered and closed.
3. Energize the controller and let the internal temperature stabilize for at least 45 minutes. If the controller has already been running for this amount of time you can skip this step.
4. Log into the system as administrator.

5. Make sure that the controller is in Stop mode.



6. On the Home screen, touch the Zone Calibration button.



The Zone Calibration screen shows (refer to Figure 16-45).



Figure 16-45 Zone Calibration Screen

When you open the Zone Calibration screen, the following actions occur:

- The mode changes to 'Calibration'.
- The Start, Standby, and Boost buttons in the header become disabled.
- All zone errors become disabled until you open a different the screen.

NOTE: If you open the Zone Calibration screen in any mode other than Stop, the buttons in the left panel will be disabled. When you stop the controller, the mode will change to Calibration and the buttons in the left panel will be enabled again.

7. Touch the zone tile button of the zone that you want to calibrate.



8. Connect the wire harness connector to the thermocouple simulator.

The thermocouple calibrator provides a standard signal level for known temperatures (a low temperature and high temperature).

NOTE: Refer to the thermocouple calibrator manual for installation instructions.

9. Connect the wire harness pins to the selected thermocouple connector inputs located on the back of the controller.

Use [Table 16-3](#) and [Table 16-4](#) for reference.

Table 16-3 Thermocouple Color Codes








ANSI Code	International IEC 584-3	International IEC 584-3 Intrinsically Safe	American Canadian	Czech British	Netherlands German	Japanese	French
J							

Table 16-4 Alloy Combination

+Lead	-Lead
#Iron Fe (magnetic)	Constantan Copper - NICKEL Cu-Ni

10. Set the thermocouple simulator to 300 °F (150 °C if the temperature units in the controller are set to Celsius).
11. Wait about 5 seconds for the reading to be stable and then touch the **Read Low** button on the left side of the Zone Calibration screen.
12. Set the thermocouple simulator to 750 °F (400 °C if the temperature units in the controller are set to Celsius).
13. Wait about 5 seconds for the reading to be stable and then touch the **Read High** button on the left side of the Zone Calibration screen.
14. Touch the **Calibrate** button on the left side of the Zone Calibration screen to calculate the simulated values and save the data for that zone to the system.
The tile button of the selected zone on the Zone Calibration screen should now show 750 °F (400 °C).
15. To do an accuracy check of the calibration, set the simulator to 500 °F (260 °C).
The tile button of the selected zone on the Zone Calibration screen should read 500 ±1 °F (260 ±1 °C) degree for the zone you have just calibrated.
16. To calibrate another zone, do the steps that follow.
 - a. Touch the zone tile button of the zone that you want to calibrate.
 - b. Connect the wire harness pins to the selected thermocouple connector inputs located on the back of the controller.
 - c. Do [step 10](#) through [step 15](#) again.
17. When you have completed the thermocouple calibration(s), disconnect the wire harness from the back of the controller and from the thermocouple simulator.

16.6 Clean the System

16.6.1 Cabinet (Mainframe)



WARNING!

Electrical and mechanical hazard- risk of death, serious injury and/or damage to the equipment. Turn off all power to the system and disconnect it completely from the main input power.

Hazardous voltages- risk of death or serious injury. Before you do service on the Altanium unit, lock-out and tag the Altanium Main Power switch in accordance with local codes.

To clean the cabinet, de-energize the system, disconnect it from the main power, and do what follows:

- Use a damp sponge or cloth. Do not use abrasives on the surface. The labels should also be wiped and no cleaners or solvents should be used.
- If a cleaner of any type must be used, a non-ammonia, non-alcohol window cleaner sprayed onto a cloth, not directly onto the cabinet, is recommended.

16.6.2 Touch Monitor

CAUTION!

Mechanical hazard - risk of damage to the equipment. Do not spray or pour any liquid directly onto the screen or case. Spray cleaner onto a lint-free cloth. If droplets are allowed to dry on the monitor permanent staining or discoloration may occur.

CAUTION!

Mechanical hazard - risk of damage to the equipment. The display area is highly prone to scratching. Do not use ketone type material (for example, acetone), ethyl alcohol, toluene, ethyl acid or methyl chloride to clear the panel. These products may permanently damage the panel and void the warranty.

To clean the touch screen, do the steps that follow:

1. Make sure the monitor is de-energized.
2. Wipe the screen with a clean, soft, lint-free cloth. This removes dust and other particles.
3. If necessary, apply a small amount of non-ammonia, nonalcohol-based glass cleaner onto a clean, soft, lint-free cloth, and wipe the screen.

16.7 Basic Troubleshooting



WARNING!

Electrical and mechanical hazard- risk of death, serious injury and/or damage to the equipment. Turn off all power to the system and disconnect it completely from the main input power.

Hazardous voltages- risk of death or serious injury. Before you do service on the Altanium unit, lock-out and tag the Altanium Main Power switch in accordance with local codes.

Use a ground strap when handling any of the Altanium components.

Table 16-5 lists some basic problems that could occur, along with possible causes and solutions that can help with troubleshooting the Altanium Delta5. If the problems shown continue after troubleshooting, or problems occur that are not shown in the table, please contact the nearest Husky Regional Service and Sales office.

Table 16-5 Troubleshooting Procedures

Problem	Possible Causes	Solution
Read Time Out	The card cannot communicate (bad, not installed, or not powered). The card is not at the address expected. The CAN bus (cables and backplanes) cannot move data. The operator interface cannot communicate with the CAN bus.	If fault is on a zone, remove and re-seat the card or replace the card. If fault is on many zones, check the supply to the controller to make sure there is not a missing phase. If the fault is on all zones, check the power and communication cable to the operator interface to make sure they are connected correctly or change the operator interface computer.
Fuse Blown (Open)	Short circuit in the mold or cabling. Output incompatible with the heater. Excessive voltage applied to the controller.	Read the mold electrical prints and use an ohmmeter or insulation resistance meter to inspect the cables and mold. It is possible that this is not a controller issue, but the connectors on the back of the controller must be inspected as well.
Over/Under Temperature	This may be setup, sensor, output, or control related.	Make sure that the Alarm window is set to an appropriate range and not too small. Recommended: $\pm 10^{\circ}\text{F}$ (6°C). Re-ART (Tune) the zone under typical molding conditions. Make sure that the mold is in the injection machine with mold cooling on and resin in the mold.

Table 16-5 Troubleshooting Procedures (Continued)

Problem	Possible Causes	Solution
Ground Fault	Bad heater. Short in wiring. Bad Card. Mis-wired mold, cable, or controller. Moisture in the heater.	Read the mold electrical prints and use an ohmmeter or insulation resistance meter to inspect the cables and mold. It is possible that this is not a controller issue, but the connectors on the back of the controller must be inspected as well. Interchange the card with a known good unit and see if the error returns. If not, replace bad the card. If moisture is suspected, set the zone temperature to a 200 °F (93 °C) and apply heat until the moisture has been baked out of the heater.
No Response	Heater is not heating sufficiently (undersized or low input voltage). Temperature of the heater cannot be sensed (pinched or displaced thermocouple).	Insufficient heat can be low supply voltage. Do a check of the supply voltage and make sure that this mold has run successfully at the present voltage. If not, connect the controller to a supply with sufficient voltage. In some conditions, the current reading may be used to see if current does flow through the heater. If no current flows, a wiring fault or bad heater could be the problem. Shorted, detached, mis-positioned or pinched thermocouples are possibilities. Do a check of the cables and wiring in the mold to make sure the thermocouples are correctly routed and terminated.
Reverse T/C	Thermocouple has been connected with reversed polarity. Card is not calibrated. Card is nonfunctional. Mold is much colder than ambient.	Insufficient heat can be low supply voltage. Do a check of the supply voltage and make sure that this mold has run successfully at the present voltage. If not, connect the controller to a supply with sufficient voltage. In some conditions, the current reading may be used to see if current does flow through the heater. If no current flows, a wiring fault or bad heater could be the problem. Shorted, detached, mis-positioned or pinched thermocouples are possibilities. Do a check of the cables and wiring in the mold to make sure the thermocouples are properly routed and terminated.

Table 16-5 Troubleshooting Procedures (Continued)

Problem	Possible Causes	Solution
No Connection, T/C	Thermocouple circuit is broken. Bad thermocouple. Card is not seated. Card is not calibrated. Card is nonfunctional. Zone far beyond 1100 °F or 600 °C.	Short the thermocouple input and it should show an ambient temperature on the operator interface. If it does, the problem is possibly a wiring issue. Inspect the cables and mold for a bad connection or broken thermocouple. If the shorted thermocouple input does not show an ambient temperature, the problem is possibly a loss of calibration or a nonfunctional card. Recalibrate the zone and if this does not work, replace the card.
Temperature Shows 0 °C (32 °F)	No communication with the card.	Refer to the Read Time Out error solution.
No Screen	Bad touch monitor or computer. Missing phase.	Do a check of the supply to the controller to make sure there is not a missing phase. Replace the touch monitor with a known good unit to see if the image is restored. If so, replace the bad touch monitor. Replace the computer with a known good unit to see if the image is restored. If so, replace the bad computer.

16.8 Failure Causes and Solutions

When the controller does a circuit test, it will stop the system and alert you if failures were detected during the test. The controller shows a window of possible causes and solutions data. Refer to [Figure 16-46](#). This window can also be opened when you touch the **Display Failure Data** button on the System Setup screen (Heats Setup tab, Monitoring tab).

NOTE: Zones that are OFF will not be shown in the list.

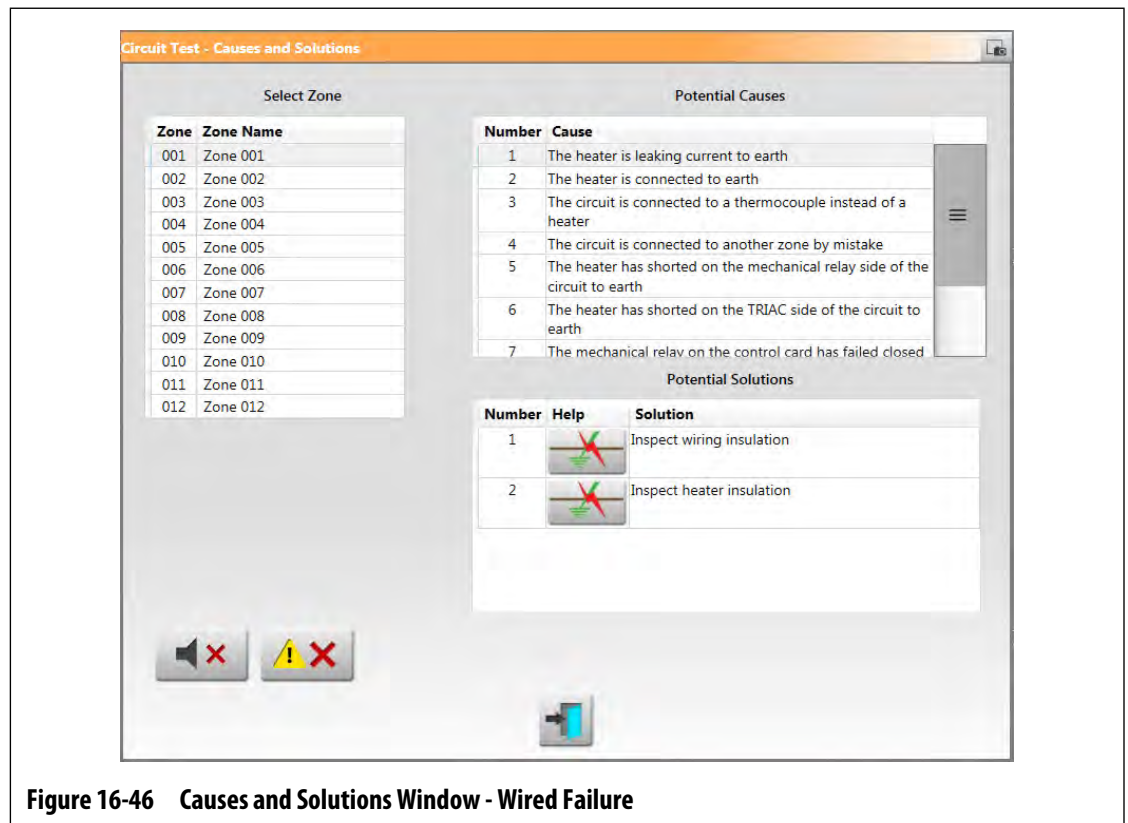


Figure 16-46 Causes and Solutions Window - Wired Failure

When you select a zone in the Select Zone field, a list of possible causes is shown in the Possible Causes field. The first possible cause of the failure is shown as number 1. Subsequent possible causes follow in numeric order. When you select a possible cause in the list, a list of solutions is shown in the Potential Solutions field.

Two buttons could show under the Help column in the Potential Solutions field:

- **View Electrical Fault** - Touch this button to see a picture to help troubleshoot the failure. It also shows a list of tools to use, procedure steps, and the results you should see. The View Electrical Fault button is shown in [Figure 16-46](#). Refer to [Figure 16-47](#) for an example of the troubleshooting procedure window for a “Heat leaking current to earth” failure.
- **Go To Card Layout** - Touch this button to see the Card Layout screen. The backplane and control card associated with the problem zone will be highlighted in red, similar to when you use the Event History screen to view errors. The Go To Card Layout button is shown in [Figure 16-48](#). Refer to [Section 16.2](#) for information about the Card Layout screen.

The Silence Horn and Reset Errors buttons are also available on the Cause and Solutions window to make it easy to work with the zone failures.

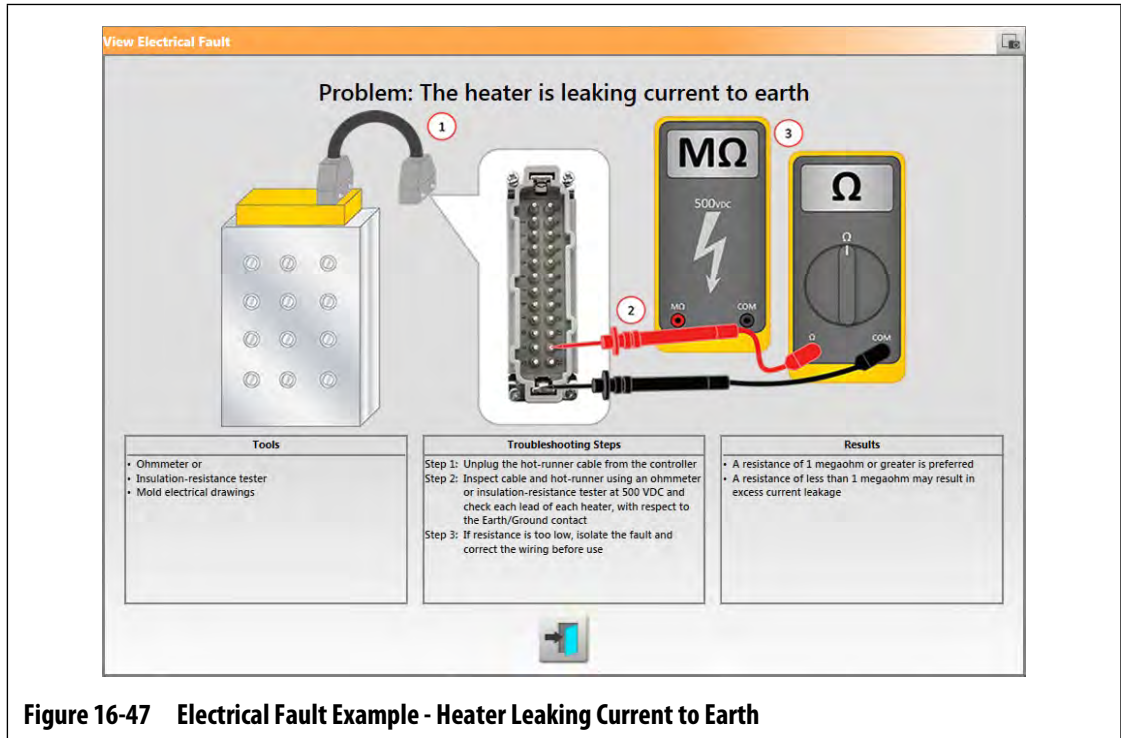


Figure 16-47 Electrical Fault Example - Heater Leaking Current to Earth

16.8.1 Supported Electrical Failures

The controller will help detect and give possible solutions for 9 electrical failures:

Wired

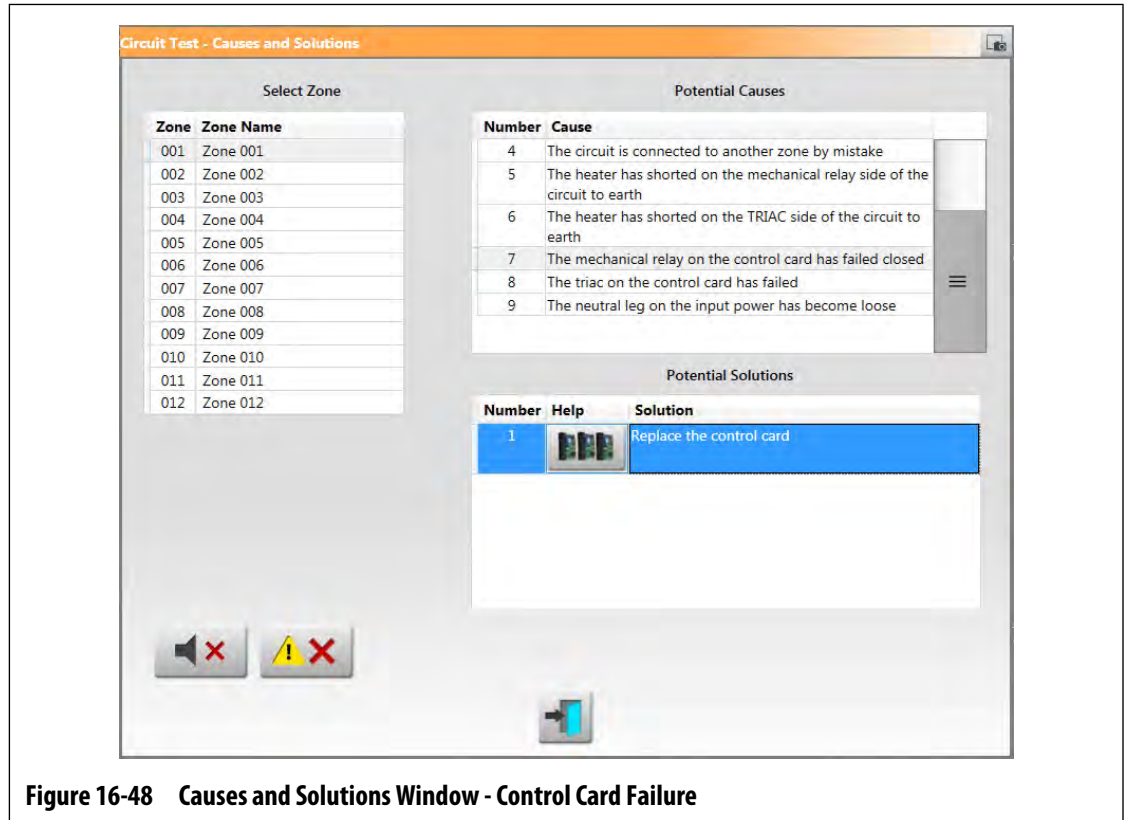
- Heater leaking current to earth
- Heater connected to earth
- Heater wired to a thermocouple
- Heater mis-wired to another zone
- Heater short on the mechanical relay side of the circuit
- Heater short on the TRIAC side of the circuit
- Loose neutral wire on the input power

Control Card Related

- The mechanical relay on the control card failed closed.
- The TRIAC on the control card failed.

The Intelligent Control Card (ICC) related failures will show the Go To Card Layout button under the Help column of the Potential Solutions field. Refer to Figure 16-48. Touch this button to see the Card Layout screen, which will help you find the ICC that caused the failure. Refer to Section 16.2 for information about the Card Layout screen.

Refer to Section 16.3.1 for information about how to replace an ICC, or Section 16.3.2 for information about how to replace an ICC open fuse.



Appendix A Glossary of Terms

Table A-1 gives the definitions for terms and symbols used in this user guide.

Table A-1 Glossary of Terms and Symbols

AMC	Automatic Manual Control
Amp or Amps	Ampere or Amperes
ANSI	American National Standards Institute
ART	Active Reasoning Technology
°C	Celsius temperature scale
CSV	Comma Separated Values (file)
dBG	Zone gain in decibels
DELTA 3PH (Input Power)	The Delta configuration has the three phases connected in a triangle shape. They do not normally have a neutral cable.
DIN	Deutsches Institut für Normung (German Institute for Standardization)
°F	Fahrenheit temperature scale
E-Stop	Emergency Stop
ft	Foot or Feet
HMI	Human Machine Interface
HRC	Hot Runner Control
Hz	Hertz
I/O	Input/Output
ICC	Intelligent Control Card
in	Inch or Inches
Imperial	Imperial Units or British Imperial Units (measurement)
IMM	Injection Molding Machine
Integrated TX (Input Power)	WYE 3PH Transformer Secondary supply power is used.
kg	Kilograms
Kwh	Kilowatt hour
lb	Pound(s)
LOTO	Lockout Tagout
m	Meter(s)

Table A-1 Glossary of Terms and Symbols (Continued)

mA	Milliampere (or milliamp)
MCU	Master Control Unit
mm	Millimeter(s)
NAK	Negative Acknowledge
NTP	Network Time Protocol
Ω	Ohm or ohms
OPC UA	Open Platform Communication Unified Architecture
PCM	Priority Control Mode
PDF	Portable Document Format (file)
PID	Proportional, Integral, and Derivative
PNG or png	Portable Network Graphics (raster-graphics file)
RH	Relative Humidity
RMS	Root Mean Square (voltage)
SI	International System of Units (measurement)
Single Phase (Input Power)	A two-wire (supply and neutral) power input is used.
SPI	Society of Plastics Industry
SSID	Service Set Identifier
T/C	Thermocouple
TXT	Text (file)
UTC	Coordinated Universal Time
VAC	Volts Alternating Current
VDC	Volts Direct Current
VGA	Video Graphics Array
VNC	Virtual Network Computing
Wye 3PH+N (Input Power)	A Wye three phase supply plus neutral configuration is when all the loads in an AC system are connected at one point. The configuration has looks like a Y shape.

Index

A

Abort

- conditions (shutdown errors) 114
- window, quick set screen 78

Active reasoning technology 87

- ART 2.0 90
- buttons 88
- manual function 89

Adjustments, making 53

Administration and security 35

Advanced settings, quick set screen 74

Alarm

- buttons 19
- conditions (warning errors) 113
- window, quick set screen 78
- zone control 154

Alarm 1 reset, SPI command 263

Alarm 1 Setpoint, SPI command 263

Alarm 2 setpoint, SPI command 263

Alarm active status, SPI command 262

Alarm and event icons 112

Alarms screen 108

- clear (reset) 110
- open 109
- states 109

AltaStart 105

ART. See Active reasoning technology

Assign follower zone to leader 80

Assistance, remote service 126

Automatic

- change manual control, quick set 85
- follow function, quick set 79
- logout 45
- power limiting 167
- thermocouple rewiring 99

B

Bake out

- cycles, configure length and number 105
- system, wet heater 104

Basic troubleshooting 310

- Boost timer settings 163
 - manual boost duration 163
 - operation description 164
 - remote boost delay 163
 - remote boost duration 163
 - remote boost input mode 164
- Buttons 17
 - active reasoning technology
 - screen 88
 - alarm 19
 - commons 25
 - controller function 17
 - dialog window 21
 - files screen 48
 - graphical view screen 60
 - help 33
 - language selection 29
 - multi group view screen 56
 - navigation 18
 - print to file 30
 - servo control 23
 - system and user management 20
 - system configurations 26
 - temperature control 24
 - temperature control views 23
 - user role 36
- C**
- Cable connections, I/O 255
- Calibration, thermocouple 306
- Card layout screen, troubleshooting
 - with 269
- Card layout, change 154
- Change header color 57
- Circuit test, heater 103
- Color change 211
 - cycle input connection 215
 - settings 214
 - start Ultra Purge process 215
 - Ultra Purge mode buttons and status 214
 - Ultra Purge process sequences 216
 - Ultra Purge sequence 213
 - Ultra Purge settings 213
- Color codes
 - electrical wire standards 3
 - thermocouple types 11
- Common buttons 25
- Conditions
 - abort 114
 - alarm 113
 - configurable signals 255
- Configurable signals 253
 - conditions 255
 - force 255
 - logic function 254
- Configuring zones 9
 - phase angle control 10
 - zero cross control 10
- Connections
 - controller to mold 13
 - cycle input, color change 215
 - I/O cables 255
 - pin-out descriptions 257
 - input base 257
 - output base 257
 - part count base 259
 - remote load base 259
 - power source 13
- Conservation, power 149
- Control settings, quick set screen 75
- Controller status, SPI command 264
- Cool down data collection, process monitoring 199
- Cooling
 - enable, mold 169
 - zone time 95
- Counting, part 149
- Create
 - new mold setup file 50
 - new mold setup folder 49
- Cross talk screen 99
- Current deviation 157
- Curve data point 190
- Cycle input connection, color change 215
- Cycle mode configuration, process monitoring 199

D

- Dashboard interface 125
- Data
 - filter, process monitoring 208
 - recording 187
- Date and time range, history plot 191
- Delay limit check, process limits 196
- Derivative control. See PID
- Detailed screen mode, neo view 62
- Detection, no heater 157
- Determine heater size 10
- Diagnostics
 - export 169
 - mold 93
 - network 134
 - results, mold 96
- Dialog window buttons 21
- Digital I/O 243
 - digital inputs 245
 - enable option 244
 - inputs
 - heats 246
 - servo 245
 - outputs
 - heats 251
 - servo 248
- Document files 47
- Dual touch monitor installation 300

E

- Earth leakage 104
 - check, quick set screen 85
- Echo, SPI command 261
- Electrical failures 314
- Energy usage and units 158
- Environmental operating specifications 4
- Equipment
 - cleaning 309
 - environmental operating specifications 4
 - input wiring 3
 - lifting instructions 5
 - maintenance 267

- protection 148
- purpose 3
- ratings 4
- restrictions of use 3
- safety signs 2
- technical specifications 4
- troubleshooting, basic 310

Errors

- shutdown 114
 - warning 113
- Event and alarm icons 112
- Event history
 - filter events 111
 - screen 110
- Export, diagnostics 169

F

- Failures
 - causes and solutions 313
 - supported electrical 314
- Fast heating, zones 106
- Files
 - screen 47
- Files screen
 - buttons 48
- Follower zone 79
- Follower zone block, Neo view 65
- Force temperature units to 148
- Force, configurable signals 255
- Frequently used fields, quick set
 - screen 70
- Function buttons 17
- Fuse on ICC replacement 276

G

- General safety 1
- Global settings, process limits 196
- Glossary of terms 317
- Graphical view screen 58
 - bar descriptions 59
 - buttons 60
- Grid size 154
- Group offset 154
- Groups, zone 54

H

Heat

- mold 103
- sequencing. See AltaStart

Heater

- circuit test 103
- current deviation 157
- determine size 10

Heating, fast 106

Heats

- control page 1 descriptions 138
- control page 2 descriptions 141
- control page 3 descriptions 142
- digital inputs 246
- digital outputs 251
- monitoring setup 144
 - page 1 descriptions 145
 - page 2 descriptions 147
- settings 137

Help, online 33

History plot screen 189

- change zone shown 192
- curve data point 190
- set date and time range 191
- set timeframe 191

History, event 110

Home screen, Altanium 16

Hot runner temperature control 9

I

Icons, alarm and event 112

Image files 47

Indicators, system status field 18

Input base connector ID 257

Input wiring 3

Inputs and outputs (I/O)

- configurable signals 253
 - conditions 255
 - force 255
 - logic function 254
- connector pin-out descriptions 257
 - input base 257
 - output base 257

part count base 259

remote load base 259

digital 243

digital inputs 245

heats 246

servo 245

digital outputs 248

heats 251

servo 248

safety signals 244

Integral control. See PID

Intelligent control cards

description 272

replacement 274

Interface, OPC UA 130

Introduction 1

K

Keyboards, screen 26

Keypads, screen 26

use 28

L

Language selection 29

Leader zone 79

Licensing and options 167

Lifting instructions, controller 5

Limiting, zone power 155

Limits

earth leakage 104

process 193

setpoint, quick set 72, 81–83

Log transfer, process monitoring 208

Logic function 254

Logout, auto 45

M

Maintenance descriptions

card layout screen 269

Delta5 operator interface 278

Delta5 system 267

intelligent control cards 272

Maintenance procedures 267
 alternative mounted operator
 interface installation 296
 clean the system 309
 dual touch monitor installation 300
 MCU removal and replacement 284
 operator interface removal and
 replacement 288
 remote operator interface
 installation 291
 replace ICC2 or ICC3 274
 replace open fuse on ICC 276
 thermocouple calibration 306
 touch monitor removal and
 replacement 280

Manual
 ART function 89
 boost, quick set screen 73
 percent output, SPI command 265
 standby, quick set screen 72

Maximum test time, mold 96

MCU removal and replacement 284

Measure, units of 148

Menus, selection 26

Modes, system 21

Mold
 bake out cycles, length and
 number 105
 cooling enable 169
 cross talk 99
 diagnostic screen 93
 diagnostics 93
 diagnostics results 96
 diagnostics test
 start 95
 earth leakage 104
 files 47
 heating 103
 load setups from IMM 152
 maximum test time, set 96
 monitor zone settings 155
 setup file
 copy 51
 create new 50
 delete 51
 discard changes 50
 load existing 51
 rename 52
 save changes 50
 save current mold file as new
 file 51
 transfer data to network 52
 transfer data to USB storage
 device 52
 setup folder, create new 49
 setups 47
 test results values 97
 testing 93
 thermocouple rewiring,
 automatic 99
 tuning, ART 2.0 90
 zone cooling time, set 95

Mold picture view
 edit mode 181
 exit edit mode 185
 graphic 177
 load graphic 178
 map network drive 177
 screen 177
 toolbar 180
 zone information panels 181
 create 182
 delete 185
 edit 183
 leader line color 184
 leader line thickness 184
 leader line, create 184
 leader line, delete 185
 move 182

Monitor zone settings 155

Mounted operator alternative interface
 installation 296

Multi group view screen 55
 buttons 56
 change header color 57

N

- Names, set zone, quick set screen 76
- Navigation buttons 18
- Neo view screen 61
 - detailed zone blocks 63
 - follower zone block 65
 - modes
 - detailed screen 62
 - simple screen 61
 - status abbreviations 65
 - zone block background color 64
- Network settings 120
 - dashboard interface 125
 - diagnostics 134
 - network share 123
 - OPC UA interface 130
 - remote service assistance 126
 - ShotscopeNX 134
 - time synchronization 135
 - virtual network computing 127
 - wired 121
 - wireless 122
- Network share 123
- No heater detection 157
- Number of system zones 158

O

- OPC UA interface 130
- Open fuse on ICC replacement 276
- Open loop control 9
- Open/closed loop, SPI command 265
- Operator interface 15, 278
 - removal and replacement 288
- Options and licensing 167
- Oscillation, PID possible causes 92
- Output base connector ID 257
- Output mode, quick set screen 79
- Output power limit, quick set 85
- Outputs and inputs. See Inputs and outputs (I/O)
- Outputs, digital 248

P

- Part counting 149
 - base connector ID 259
 - reset 150
 - sack full output optimization 150
 - set 149
- PID control 92
- Pin-out descriptions
 - input base 257
 - output base 257
 - part count base 259
 - remote load base 259
- Power
 - automatic limiting 167
 - conservation 149
 - deviation, zone 155
 - limiting 155
- Preferences, user 45
- Print to file 30
 - report descriptions 31
- Priority control mode, change 84
- Process limits screen 193
 - delay limit check 196
 - global settings 196
 - limits descriptions 194
 - process variable selector 196
 - target settings 195
- Process monitoring setup screen 198
 - cool down data collection 199
 - cycle mode configuration 199
 - data filter 208
 - log transfer 208
 - save data setup 209
 - status 208
 - time mode configuration 198
- Process setpoint, SPI command 262
- Process Value, SPI command 262
- Process variable selector, process limits 196
- Proportional control. See PID
- Protection, equipment 148
- Purpose, equipment 3

Q

- Quick adjustment panel 69
- Quick set screen 70
 - abort window 78
 - advanced settings 74
 - alarm window 78
 - ART to PID, change 86
 - automatic manual control 85
 - control settings 75
 - earth leakage check, change 85
 - frequently used fields 70
 - manual boost 73
 - manual standby 72
 - output mode 79
 - output power limit, change 85
 - priority control mode, change 84
 - regulation mode 80
 - remote boost 74
 - remote standby 73
 - setpoint limits 72, 81–83
 - temperature setpoints 78
 - thermocouple sensor assignment 84
 - zone
 - edit 71
 - follow 79
 - name 76
 - setpoint fields 70

R

- Ratings, equipment 4
- Recording, data 187
- Regulation mode, quick set screen 80
- Remote
 - boost delay timer, set 163
 - boost duration timer, set 163
 - boost, quick set screen 74
 - load 152
 - load base connector ID 259
 - operator interface installation 291
 - service assistance 126
 - standby delay timer, set 160
 - standby duration timer, set 160
 - standby input mode, set 161
 - standby, quick set screen 73

- Report files 47
- Resin protection timer 165
 - cycle idle reaction 166
 - cycle idle time limit 166
 - degradation limit 166
- Restrictions of use 3

S

- Safety
 - equipment signs 2
 - signals 244
- Save data setup, process monitoring 209
- Screen keyboards 26
- Screen security, servo 44
- Screens
 - alarms 108
 - ART process 87
 - card layout 269
 - color change 212
 - cross talk 99
 - diagnostics results 96
 - event history 110
 - files, mold - images - documents - reports 47
 - graphical view screen 58
 - Heats setup control page 1 138
 - Heats setup control page 2 141
 - Heats setup control page 3 142
 - history plot 189
 - home screen 16
 - mold diagnostic 93
 - mold picture view 177
 - monitoring 1, heats 144
 - monitoring 2, heats 147
 - multi group view 55
 - neo view 61
 - network settings 120
 - process limits 193
 - process monitoring setup 198
 - quick set 70
 - security - heats page 1 41
 - security - heats page 2 43
 - security - main 1 38
 - security - main 2 40

- security - servo 44
- staging 170
- supply voltage 173
- system setup
 - main 1 118
 - main 2 120
- temperature graphs 100
- text view 66
- trend plot 187
- user management 35
- zone slot 158
- Security and administration 35
- Security screens 35
- Selection menus, screen 26
- Selection, zone 53, 68
- Sensor assignment (thermocouple),
 - quick set 84
- Service assistance, remote 126
- Servo
 - control buttons 23
 - digital inputs 245
 - digital outputs 248
- Set screen security 38
 - heats page 1 41
 - heats page 2 43
 - main 1 38
 - main 2 40
- Setpoint limits, quick set screen 72, 81–83
- Setpoints
 - enter value with keypad 28
 - fields, zone 70
 - limits, quick set screen 81
 - staged temperature and power 172
 - temperature, quick set screen 78
- ShotscopeNX 134
- Shutdown errors 114
- Signals
 - configurable 253
 - safety 244
- Signs, equipment safety 2
- Simple screen mode, neo view 61
- Society of Plastics Industry. See SPI protocol 261
- Soft start
 - disable 107
 - enable 107
 - minimum limit, adjust 108
 - zones 107
- Sorting, text view screen 68
- Specifications, equipment 4
- SPI protocol 261
 - command summary 261
 - commands
 - alarm 1 reset 263
 - alarm 1 setpoint 263
 - alarm 2 setpoint 263
 - alarm active status 262
 - controller status 264
 - echo 261
 - manual percent output 265
 - open/closed loop 265
 - process setpoint 262
 - process value 262
- Split-screen mode
 - button 60
 - graphical view 61
 - text view 68
- Staged
 - hold a setpoint 172
 - shutdown, enable/disable 172
 - soak timers, set 173
 - startup and shutdown 169
 - startup, enable/disable 171
 - temperature and power setpoints 172
- Staging screen 170
 - settings 171
- Standby timer settings 159
 - manual standby duration 159
 - operation description 161
 - remote standby delay 160
 - remote standby duration 160
 - remote standby input mode 161
- Startup
 - before you start controller 13
 - power source connection 13
 - procedure checklist 14

Status

- abbreviations, neo view blocks 65
- field indicators 18
- process monitoring 208

Supply voltage

- configure 176
- screen 173

Synchronization, time 135

System

- cleaning 309
- configuration buttons 26
- modes 21
- number of zones 158
- optional features and licensing 167, 243
- options 243
- setup 117
 - main 1 screen 118
 - main 2 screen 120

System and user management

- buttons 20

T

Target settings, process limits 195

Technical specifications 4

Temperature

- control buttons 24
- control views buttons 23
- control, hot runner 9
- graphs screen 100
- open loop control 9
- setpoints, quick set screen 78
- types of control 9

Terms, glossary of 317

Test

- heater circuit 103
- mold 93
- mold diagnostics start 95

Text view screen 66

- sorting 68
- split-screen mode 68
- zone selection 68

Thermocouple

- calibration 306
- rewiring, automatic 99
- sensor assignment, quick set 84
- types and color codes 11

Time mode configuration, process monitoring 198

Time range and date, history plot 191

Time synchronization 135

Timeframe, history plot 191

Timer

- resin protection 165
- standby settings 159

Touch monitor removal and replacement 280

Trend plot screen 187

Troubleshooting

- basic 310
- with card layout screen 270

Tuning, ART 2.0 mold 90

Types of temperature control 9

U

Ultra Purge

- mode buttons and status 214
- process sequences 216
 - no color change 234–242
 - non-thermal sensitive resin 216–225
 - thermal sensitive resin 225–234
- sequence 213
- settings 213
- start process 215

UniStart 106

Units of measure 148

User management and system

- buttons 20

User management screen 35

User preferences 45

V

Values

- PID typical 92
- test results, mold 97

Virtual network computing 127

W

- Warning errors 113
- Wet heater bake out system 104
- Wired network setup 121
- Wireless network setup 122

Z

Zone

- alarm control 154
- block background color, neo view 64
- blocks, neo view 63
- control (change ART to PID), quick set 86
- edit, quick set screen 71
- follow, quick set
 - automatic follow 79
 - manually assign follower to leader 80
- follow, quick set screen 79
- monitor settings 155

Zones

- AltaStart 105
- assign follower to leader 80
- configuring 9
- cooling time, set 95
- fast heating 106
- make groups 54
- names, quick set screen 76
- number in system 158
- power deviation 155
- power limiting 155
- selection 53
- setpoint fields, quick set screen 70
- soft start 107
- UniStart 106